



CANADA'S LEADING MATERIAL HANDLING SUPPLIER

CATALOGUE K0921





KLETON

Quality and Value Built into Every Product

Started in 1978, KLETON has become Canada's leading Material Handling supplier. From workbenches to rolling ladders, storage cabinets to packaging equipment, the KLETON line is a solid value when you require material handling and warehouse equipment!

This catalogue has been designed as a tool for you, our customer. Behind it stands an expertly qualified team ready to answer any questions you may have.

We hope you enjoy it!



Do you have a custom application?

Not a problem! KLETON specializes in custom requests. Look for the "K" custom logo throughout this catalogue. Don't see what you're looking for? Simply contact one of our sales representatives and we'll be pleased to help you out.

Customize . . .

- Strip Curtain Doors
- Platform Trucks
- Safety Guards
- Bollards
- Gas Cylinder Cabinets
- Workbenches
- Shelf Trucks
- And more...

Contact us today!

KLETON

Built Tough!



QUICK INDEX

WAREHOUSE AND STORAGE

3 - 50

LADDERS, STANDS & PLATFORMS

51-58

MATERIAL HANDLING

59-119

SHOP FURNITURE

120-144

DRUM HANDLING EQUIPEMENT

145-149

DRUM PUMP AND ACCESSORIES

150-158

PACKAGING

159-175





WAREHOUSING & STORAGE

| | | | |
|--|-------------|--|---------|
| Lockers | 4 - 5 | Collapsible Containers | 30 |
| Locker Room Benches | 5 | Storage Bins & Racks | 31 - 34 |
| Wire Shelving | 6 - 19 | Bulk Stacking Containers | 35 |
| Chromate Wire Carts | 10 | Stacking Racks | 36 |
| Wire Shelving with Storage Bins | 11, 14 | Reel Dispensers | 36 |
| Slanted & Basket Wire Shelving | 11 - 14 | Storage Racks | 37 - 38 |
| Wire Stock Picking Carts | 10, 14 - 15 | Gas Cylinder Cabinets | 39 |
| Wire Office Mail Carts | 10, 14 - 15 | Wire Mesh Partitions | 40 - 42 |
| Green Epoxy Finish Wire Shelving | 15 - 17 | Safety Guards | 43 |
| Wide Span Shelving | 18 | Racking Protectors | 44 |
| Heavy-Duty Bottless Shelving | 19 | Guard Rails | 44 - 46 |
| Parts Cabinets | 20 - 23 | Bollards, Protectors & Safety Guards | 45 |
| Carousel Cabinet | 20 | Strip Curtain Doors | 47 |
| Storage Cabinets | 24 - 26 | Tarpaulins | 48 - 49 |
| Hi-Stak Plastic Storage Bins | 27 | Rubber Tie Downs | 50 |
| Plastic Bins | 27 - 28 | Furniture Pads | 50 |
| Drawer Cabinets | 29 | | |

LOCKERS & LOCKER ROOM BENCHES

READY TO ASSEMBLE, THESE 16 GAUGE QUALITY LOCKERS WILL HELP KEEP BELONGINGS SAFE AND ORGANIZED.

READY TO ASSEMBLE STEEL LOCKERS

- Ships knocked down, ready to assemble with nuts and bolts included
- 16-gauge frames, 24-gauge body and shelves
- Double pan construction doors, 20-gauge outer and 24-gauge inner pans
- Stainless steel recessed padlock handles
- Magnetic latch ensures door is properly fastened when closed
- Three zinc-plated coat hooks and one shelf included with single and double tier lockers
- Durable powder-coated grey paint finish
- Number plates available separately
- Single tier dimensions: 12" W x 18" D x 72" H
- Double tier door height: 33-1/4"
- Lockerettes door height: 11"



SINGLE TIER

Dimensions:
12" W x 18" D x 72" H



DOUBLE TIER

Dimensions:
12" W x 18" D x 72" H
33-1/4" height per locker



LOCKERETTES

Dimensions:
12" W x 18" D x 72" H
11" height per lockerette



Three zinc-plated coat hooks and one shelf included with single and double tier lockers



Stainless steel recessed padlock handles. Magnetic latch ensures door is properly fastened when closed



Double pan construction doors, 20-gauge outer and 24-gauge inner pans 16-gauge frames, 24-gauge body and shelves

LOCKER ROOM BENCHES

- 16 gauge steel all-welded
- Wood top benches feature black powder coated legs that can be used free-standing or bolted to the floor
- Necessary for any locker room
- 9-1/4" wide rounded hardwood top



FB002



RL871

| Model No. | Type | Dimensions L" x W" x H" | Wt. lbs. |
|-----------|-------|-------------------------|----------|
| FB002 | Steel | 72 x 12 x 17 | 35 |
| RL871 | Wood | 48 x 9-1/2 x 16-1/2 | 23 |
| RL872 | Wood | 60 x 9-1/2 x 16-1/2 | 28 |
| RL873 | Wood | 72 x 9-1/2 x 16-1/2 | 31 |
| RL874 | Wood | 96 x 9-1/2 x 16-1/2 | 38 |

SINGLE TIER



| Model No. | Bank of | Wt. lbs. |
|-----------|---------|----------|
| FL362 | 1 | 54 |
| FL363 | 2 | 98 |
| FL364 | 3 | 142 |

W/SLOPE TOP

| | | |
|-------|---|-----|
| FL380 | 1 | 60 |
| FL381 | 2 | 109 |
| FL382 | 3 | 158 |

W/RECESSED BASE

| | | |
|-------|---|-----|
| FL392 | 1 | 59 |
| FL393 | 2 | 108 |
| FL394 | 3 | 157 |

W/SLOPE TOP & RECESSED BASE

| | | |
|-------|---|-----|
| FL404 | 1 | 65 |
| FL405 | 2 | 119 |
| FL406 | 3 | 174 |

DOUBLE TIER



| Model No. | Bank of | Wt. lbs. |
|-----------|---------|----------|
| FL366 | 1 | 56 |
| FL367 | 2 | 100 |
| FL368 | 3 | 144 |

W/SLOPE TOP

| | | |
|-------|---|-----|
| FL384 | 1 | 61 |
| FL385 | 2 | 111 |
| FL386 | 3 | 160 |

W/RECESSED BASE

| | | |
|-------|---|-----|
| FL396 | 1 | 61 |
| FL397 | 2 | 110 |
| FL398 | 3 | 159 |

W/SLOPE TOP & RECESSED BASE

| | | |
|-------|---|-----|
| FL408 | 1 | 67 |
| FL409 | 2 | 121 |
| FL410 | 3 | 176 |

LOCKERETTES



| Model No. | Bank of | Wt. lbs. |
|-----------|---------|----------|
| FL370 | 1 | 60 |
| FL371 | 2 | 108 |
| FL372 | 3 | 159 |

W/SLOPE TOP

| | | |
|-------|---|-----|
| FL388 | 1 | 66 |
| FL389 | 2 | 119 |
| FL390 | 3 | 175 |

W/RECESSED BASE

| | | |
|-------|---|-----|
| FL400 | 1 | 65 |
| FL401 | 2 | 118 |
| FL402 | 3 | 174 |

W/SLOPE TOP & RECESSED BASE

| | | |
|-------|---|-----|
| FL412 | 1 | 71 |
| FL413 | 2 | 129 |
| FL414 | 3 | 190 |



SLOPE TOP

- Helps eliminate dust build up
- Raises top by 10"



RECESSED BASE

- Prevents liquids from entering the locker
- Raises locker 4" off the ground

| Model No. | Description |
|-----------|----------------------------------|
| FL375 | 10" Slope Top |
| FL374 | 4" Recessed Base |
| FL376 | Nuts & Bolts, Set of 1 |
| FL518 | Number Plates (Set of 1 to 25) |
| FL519 | Number Plates (Set of 26 to 50) |
| FL520 | Number Plates (Set of 51 to 75) |
| FL521 | Number Plates (Set of 76 to 100) |

STANDARD DUTY WIRE SHELVING

STANDARD DUTY WIRE MESH SHELVING

- Assembly required
- Shelf ribs run front to back allowing items to slide on and off shelves smoothly
- Adjustable feet compensate for surface irregularities
- Posts are double grooved every 8" and numbered for easy adjustment
- Capacity is based on evenly-distributed weight
- Post's circular grooves combined with tapered plastic split sleeves allow for assembly in minutes with no special tools
- Shelves with open wire design minimize dust, improve air circulation and provide greater visibility of stored items
- Shelves can be adjusted at precise 1" intervals
- Unit capacity should not exceed 1000 lbs.
- NSF Certified

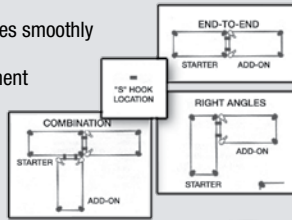

| Model No. | Type | Dimensions D" x W" x H" | Cap Lbs. /Shelf* |
|-----------|---------|-------------------------|------------------|
| RN529 | Starter | 14 x 36 x 63 | 500 |
| RN530 | Add-on | 14 x 36 x 63 | 500 |
| RN531 | Starter | 18 x 36 x 63 | 500 |
| RN532 | Add-on | 18 x 36 x 63 | 500 |
| RN533 | Starter | 18 x 48 x 63 | 500 |
| RN534 | Add-on | 18 x 48 x 63 | 500 |
| RN535 | Starter | 24 x 48 x 63 | 500 |
| RN536 | Add-on | 24 x 48 x 63 | 500 |
| RN537 | Starter | 24 x 72 x 63 | 400 |
| RN538 | Add-on | 24 x 72 x 63 | 400 |
| RN539 | Starter | 14 x 36 x 74 | 500 |
| RN540 | Add-on | 14 x 36 x 74 | 500 |
| RN541 | Starter | 18 x 36 x 74 | 500 |
| RN542 | Add-on | 18 x 36 x 74 | 500 |
| RN543 | Starter | 18 x 48 x 74 | 500 |
| RN544 | Add-on | 18 x 48 x 74 | 500 |
| RN545 | Starter | 24 x 48 x 74 | 500 |
| RN546 | Add-on | 24 x 48 x 74 | 500 |
| RN547 | Starter | 24 x 72 x 74 | 400 |
| RN548 | Add-on | 24 x 72 x 74 | 400 |

* Evenly distributed weight

WIRE SHELVING COMPONENTS

- Shelf ribs run front to back allowing items to slide on and off shelves smoothly
- Shelves can be adjusted at precise 1" intervals
- Posts are double grooved every 8" and numbered for easy adjustment
- Adjustable feet compensate for surface irregularities
- Stationary unit's total capacity should not exceed 1000 lbs.
- Assembly required
- NSF certified

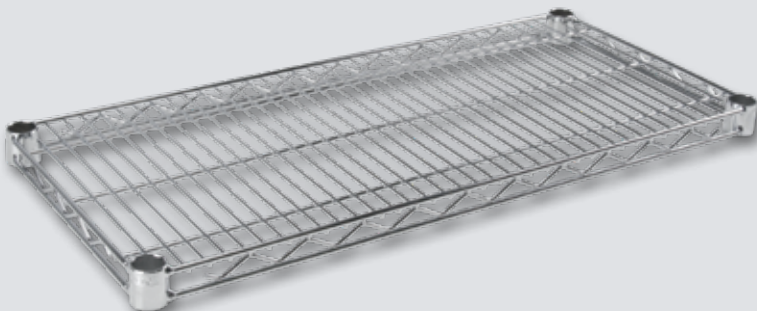

POSTS

| Model No. | Height" | Wt. lbs. |
|-----------|---------|----------|
| RN522 | 63 | 2.75 |
| RN523 | 74 | 3.2 |

WIRE SHELVES

| Model No. | Dimensions D" x W" | Cap lbs.* | Wt. lbs. |
|-----------|--------------------|-----------|----------|
| RN524 | 14 x 36 | 500 | 6.8 |
| RN525 | 18 x 36 | 500 | 8 |
| RN526 | 18 x 48 | 500 | 10.8 |
| RN527 | 24 x 48 | 500 | 13.3 |
| RN528 | 24 x 72 | 400 | 18.9 |

* Evenly distributed weight

STANDARD DUTY WIRE SHELVING ACCESSORIES

WIRE BASKET SHELVES

- Shelves can be adjusted at precise 1" intervals
- Basket shelf design allows loose items to be contained and easily displayed
- NSF certified

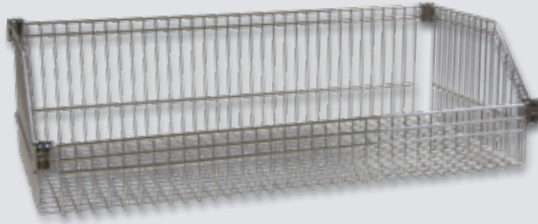

| Model No. | Dimensions D" x W" | Cap lbs.* | Wt. lbs. |
|-----------|--------------------|-----------|----------|
| RN549 | 18 x 36 | 400 | 8 |
| RN550 | 18 x 48 | 400 | 9 |
| RN551 | 24 x 48 | 400 | 12.6 |

* Evenly distributed weight

WIRE SLANTED SHELVES

- Shelves can be adjusted at precise 1" intervals
- Slanted shelf design allows for visibility and easy access to stored goods
- 3" front lip prevents items from sliding off the shelf
- NSF certified

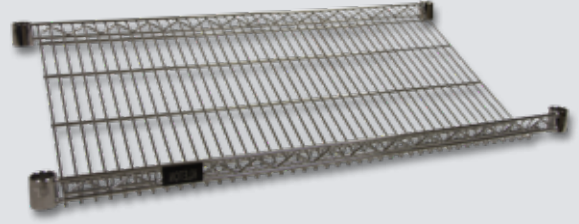

| Model No. | Dimensions D" x W" | Cap lbs.* | Wt. lbs. |
|-----------|--------------------|-----------|----------|
| RN552 | 18 x 36 | 400 | 8.45 |
| RN553 | 18 x 48 | 400 | 9 |
| RN554 | 24 x 48 | 400 | 13 |

* Evenly distributed weight

ACCESSORIES



RL048



RL049



RL050
Divider



RL055
"S" Hook

Use S hooks to eliminate two posts per adjacent shelf. Two required per shelf.



RL054 - Split Sleeve

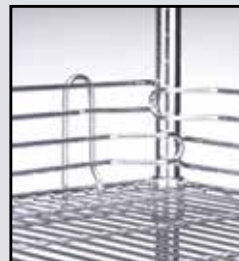

RL614 Ledge for Shelf

| Model No. | Description | Wt. lbs. |
|-----------|--|----------|
| RL048 | Caster, 5", no brake | 2 |
| RL049 | Caster, 5", with brake | 2.25 |
| RL050 | Divider for shelf, 18" | 1 |
| RL051 | Divider for shelf, 24" | 2.3 |
| RL052 | Handle 18" - For utility carts | 3.9 |
| RL053 | Handle 24" - For utility carts | 4.4 |
| RL054 | Split Sleeves, black 4 Pc/bag | 0.1 |
| RL055 | S-Hook for attaching Add-On | 0.04 |
| RL056 | Leveling feet (Die cast and foot bolt) | 0.2 |
| RL057 | Die cast for leveling feet | 0.1 |
| RL058 | Foot bolt for leveling feet | 0.1 |
| RL614 | Ledge for shelf, 14" | 0.72 |
| RL615 | Ledge for shelf, 18" | 0.88 |
| RL616 | Ledge for shelf, 24" | 1.14 |
| RL617 | Ledge for shelf, 30" | 1.4 |
| RL618 | Ledge for shelf, 36" | 1.7 |
| RL619 | Ledge for shelf, 48" | 2.28 |
| RL620 | Ledge for shelf, 60" | 2.58 |
| RL621 | Ledge for shelf, 72" | 3.2 |

RL056
Leveling
Foot



RN522
Post



HEAVY DUTY WIRE SHELVING ACCESSORIES

- Heavy-gauge chromate plated shelves with open wire design minimize dust, improve air circulation and provide greater visibility of stored items.
- Post's circular grooves combined with tapered plastic split sleeves allow for assembly in minutes with no special tools.

WIRE SHELVING COMPONENTS

- Shelf ribs run front to back allowing items to slide on and off shelves smoothly
- Shelves can be adjusted at precise 1" intervals
- Posts are double grooved every 8" and numbered for easy adjustment
- Adjustable feet compensate for surface irregularities
- Stationary unit's total capacity should not exceed 2000 lbs.
- Assembly required
- NSF Certified



WIRE SHELVES

| Model No. | Dimensions D" x W" | Cap lbs.* | Wt. lbs. |
|-----------|--------------------|-----------|----------|
| RL606 | 14 x 30 | 800 | 7.5 |
| RL607 | 14 x 36 | 800 | 8.25 |
| RL608 | 14 x 48 | 800 | 10.5 |
| RL609 | 14 x 60 | 600 | 12 |
| RL610 | 14 x 72 | 600 | 15 |
| RL035 | 18 x 30 | 800 | 6.9 |
| RL036 | 18 x 36 | 800 | 8.5 |
| RL037 | 18 x 48 | 800 | 10 |
| RL038 | 18 x 60 | 600 | 14.5 |
| RL039 | 18 x 72 | 600 | 15 |
| RL040 | 24 x 36 | 800 | 10.5 |

WIRE SHELVES

| Model No. | Dimensions D" x W" | Cap lbs.* | Wt. lbs. |
|-----------|--------------------|-----------|----------|
| RL041 | 24 x 48 | 800 | 14 |
| RL042 | 24 x 60 | 600 | 17.8 |
| RL043 | 24 x 72 | 600 | 22 |

* Evenly distributed weight

POSTS

| Model No. | Height" | Wt. lbs. |
|-----------|---------|----------|
| RL611 | 33 | 1.75 |
| RL330 | 54 | 3.1 |
| RL331 | 63 | 3.5 |
| RL332 | 74 | 3.9 |
| RL333 | 86 | 4.8 |

ACCESSORIES



RL048



RL049



RL050
Divider



RL054 - Split Sleeve



RL055
"S" Hook

Use S hooks to eliminate two posts per adjacent shelf. Two required per shelf.



RL056
Leveling Foot



RL330
Post



RL614 Ledge for Shelf



RL612
Single Shelf Support



RL613
Double Shelf Support

| Model No. | Description | Wt. lbs. |
|-----------|--|----------|
| RL048 | Caster, 5", no brake | 2 |
| RL049 | Caster, 5", with brake | 2.25 |
| RL050 | Divider for shelf, 18" | 1 |
| RL051 | Divider for shelf, 24" | 2.3 |
| RL052 | Handle 18" - For utility carts | 3.9 |
| RL053 | Handle 24" - For utility carts | 4.4 |
| RL054 | Split Sleeves, black 4 Pc/bag | 0.1 |
| RL055 | S-Hook for attaching Add-On | 0.04 |
| RL056 | Leveling feet (Die cast and foot bolt) | 0.2 |
| RL057 | Die cast for leveling feet | 0.1 |
| RL058 | Foot bolt for leveling feet | 0.1 |
| RL614 | Ledge for shelf, 14" | 0.72 |
| RL615 | Ledge for shelf, 18" | 0.88 |
| RL616 | Ledge for shelf, 24" | 1.14 |
| RL617 | Ledge for shelf, 30" | 1.4 |
| RL618 | Ledge for shelf, 36" | 1.7 |
| RL619 | Ledge for shelf, 48" | 2.28 |
| RL620 | Ledge for shelf, 60" | 2.58 |
| RL621 | Ledge for shelf, 72" | 3.2 |

DIRECT WALL MOUNTS FOR WIRE SHELVING

- Same great features as the KLETON chromate wire shelving, but with the added convenience of directly mounting on a wall.
- Wall mounts maximize available floor space
 - Each wall mount unit consists of one shelf support and mounting plate
 - Use single support at shelf ends; double support for adjoining shelves
 - Installation note: Wall mounts must be securely fastened to materials of adequate load bearing strength. (Load rating: 200 lbs. (91kg) per system)

| Model No. | Shelf Support | Shelf Depth" |
|-----------|---------------|--------------|
| RL612 | Single | 14 |
| RL898 | Single | 18 |
| RL900 | Single | 24 |
| RL613 | Double | 14 |
| RL899 | Double | 18 |
| RL901 | Double | 24 |

WALL MOUNT WIRE SHELVING KITS

- Kit includes shelves, supports and mounting plate

| Model No. | Description | Shelf Dimensions D" x W" |
|-----------|-------------|--------------------------|
| RL911 | 1 Shelf | 14" x 30" |
| RL912 | 2 Shelves | 14" x 30" |

RL911
Shelf & Support Kit

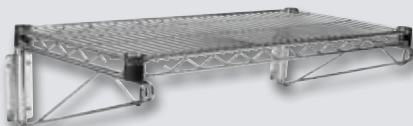

KLETON WIRE SHELVING CAN BE ASSEMBLED IN SEVERAL CONFIGURATIONS END TO END, AT RIGHT ANGLES AS WELL AS MANY OTHER COMBINATIONS.

HEAVY DUTY WIRE SHELVING

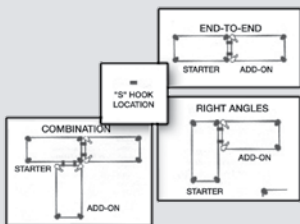

5 SHELVES

| Model No. | Type | Dimensions D" x W" x H" | Cap Lbs. /Shelf* | Wt. Lbs. |
|------------------|---------|-------------------------|------------------|----------|
| 74" POSTS | | | | |
| RL909 | Starter | 14 x 30 x 74 | 800 | 46.4 |
| RL910 | Add-On | 14 x 30 x 74 | 800 | 39.1 |
| RL640 | Starter | 14 x 36 x 74 | 800 | 51 |
| RL641 | Add-on | 14 x 36 x 74 | 800 | 43.5 |
| RL642 | Starter | 14 x 48 x 74 | 800 | 59 |
| RL643 | Add-on | 14 x 48 x 74 | 800 | 42.8 |
| RL644 | Starter | 14 x 60 x 74 | 600 | 78.75 |
| RL645 | Add-on | 14 x 60 x 74 | 600 | 71 |
| RL646 | Starter | 14 x 72 x 74 | 600 | 87.3 |
| RL647 | Add-on | 14 x 72 x 74 | 600 | 79.5 |
| RL075 | Starter | 18 x 36 x 74 | 800 | 58 |
| RL076 | Add-on | 18 x 36 x 74 | 800 | 51 |
| RL077 | Starter | 18 x 48 x 74 | 800 | 65 |
| RL078 | Add-on | 18 x 48 x 74 | 800 | 58 |
| RL079 | Starter | 18 x 60 x 74 | 600 | 88 |
| RL080 | Add-on | 18 x 60 x 74 | 600 | 80 |
| RL081 | Starter | 18 x 72 x 74 | 600 | 92 |
| RL082 | Add-on | 18 x 72 x 74 | 600 | 85 |
| RL083 | Starter | 24 x 36 x 74 | 800 | 68 |
| RL084 | Add-on | 24 x 36 x 74 | 800 | 61 |
| RL085 | Starter | 24 x 48 x 74 | 800 | 85 |
| RL086 | Add-on | 24 x 48 x 74 | 800 | 78 |
| RL087 | Starter | 24 x 60 x 74 | 600 | 103 |
| RL088 | Add-on | 24 x 60 x 74 | 600 | 95 |
| RL089 | Starter | 24 x 72 x 74 | 600 | 125 |
| RL090 | Add-on | 24 x 72 x 74 | 600 | 118 |

4 SHELVES

| Model No. | Type | Dimensions D" x W" x H" | Cap Lbs. /Shelf* | Wt. Lbs. |
|------------------|---------|-------------------------|------------------|----------|
| 63" POSTS | | | | |
| RL907 | Starter | 14 x 30 x 63 | 800 | 38.6 |
| RL908 | Add-on | 14 x 30 x 63 | 800 | 32 |
| RL632 | Starter | 14 x 36 x 63 | 800 | 42.6 |
| RL633 | Add-on | 14 x 36 x 63 | 800 | 35.5 |
| RL634 | Starter | 14 x 48 x 63 | 800 | 49 |
| RL635 | Add-on | 14 x 48 x 63 | 800 | 42 |
| RL636 | Starter | 14 x 60 x 63 | 600 | 64.75 |
| RL637 | Add-on | 14 x 60 x 63 | 600 | 57.75 |
| RL638 | Starter | 14 x 72 x 63 | 600 | 71.5 |
| RL639 | Add-on | 14 x 72 x 63 | 600 | 64 |
| RL059 | Starter | 18 x 36 x 63 | 800 | 48 |
| RL060 | Add-on | 18 x 36 x 63 | 800 | 41.6 |
| RL061 | Starter | 18 x 48 x 63 | 800 | 58 |
| RL062 | Add-on | 18 x 48 x 63 | 800 | 53.5 |
| RL063 | Starter | 18 x 60 x 63 | 600 | 71 |
| RL064 | Add-on | 18 x 60 x 63 | 600 | 65 |
| RL065 | Starter | 18 x 72 x 63 | 600 | 75 |
| RL066 | Add-on | 18 x 72 x 63 | 600 | 68 |
| RL067 | Starter | 24 x 36 x 63 | 800 | 56 |
| RL068 | Add-on | 24 x 36 x 63 | 800 | 49 |
| RL069 | Starter | 24 x 48 x 63 | 800 | 70 |
| RL070 | Add-on | 24 x 48 x 63 | 800 | 63 |
| RL071 | Starter | 24 x 60 x 63 | 600 | 83 |
| RL072 | Add-on | 24 x 60 x 63 | 600 | 77 |
| RL073 | Starter | 24 x 72 x 63 | 600 | 101 |
| RL074 | Add-on | 24 x 72 x 63 | 600 | 95 |

* Evenly distributed weight

86" POSTS

| | | | | |
|-------|---------|--------------|-----|------|
| RL448 | Starter | 18 x 36 x 86 | 800 | 62 |
| RL449 | Add-on | 18 x 36 x 86 | 800 | 53 |
| RL450 | Starter | 18 x 48 x 86 | 800 | 69 |
| RL451 | Add-on | 18 x 48 x 86 | 800 | 60 |
| RL452 | Starter | 18 x 60 x 86 | 600 | 91.5 |
| RL453 | Add-on | 18 x 60 x 86 | 600 | 82 |
| RL454 | Starter | 18 x 72 x 86 | 600 | 96 |
| RL455 | Add-on | 18 x 72 x 86 | 600 | 87 |
| RL456 | Starter | 24 x 36 x 86 | 800 | 74 |
| RL457 | Add-on | 24 x 36 x 86 | 800 | 65 |
| RL458 | Starter | 24 x 48 x 86 | 800 | 90 |
| RL459 | Add-on | 24 x 48 x 86 | 800 | 80 |
| RL460 | Starter | 24 x 60 x 86 | 600 | 107 |
| RL461 | Add-on | 24 x 60 x 86 | 600 | 97 |
| RL462 | Starter | 24 x 72 x 86 | 600 | 129 |
| RL463 | Add-on | 24 x 72 x 86 | 600 | 120 |

* Evenly distributed weight

CHROMATE WIRE CARTS

WIRE MESH UTILITY CARTS

- Durable, dependable transport solution
- Highly rigid construction that is easily adjustable at 1" increments
- Two handles allow for easy maneuverability
- Includes: 5" resilient rubber casters (two swivel, two with brake)
- One year limited warranty
- Shipped knocked down
- NSF Certified

**800 - LB.
CAPACITY**
Evenly Distributed



| Model No. | Dimensions W" x D" x H" | Wt. lbs. |
|-----------|-------------------------|----------|
|-----------|-------------------------|----------|

2 SHELVES

| | | |
|--------------|--------------|-------|
| MK781 | 30 x 18 x 45 | 42.25 |
| MK782 | 36 x 18 x 45 | 46.6 |
| MK783 | 48 x 18 x 45 | 48.5 |
| MK784 | 60 x 18 x 45 | 57.5 |
| MK785 | 36 x 24 x 45 | 38.5 |
| MK786 | 48 x 24 x 45 | 45.25 |
| MK787 | 60 x 24 x 45 | 52.25 |

| Model No. | Dimensions W" x D" x H" | Wt. lbs. |
|-----------|-------------------------|----------|
|-----------|-------------------------|----------|

3 SHELVES

| | | |
|--------------|--------------|-------|
| MJ539 | 30 x 18 x 45 | 49.2 |
| MJ540 | 36 x 18 x 45 | 54.2 |
| MJ541 | 48 x 18 x 45 | 58.5 |
| MJ542 | 60 x 18 x 45 | 71.9 |
| MJ543 | 36 x 24 x 45 | 49.1 |
| MJ544 | 48 x 24 x 45 | 59.3 |
| MJ545 | 60 x 24 x 45 | 69.75 |

PUSH CARTS

- Durable, dependable transport solution
- Easy maneuverability
- Shelves can be adjusted quickly and easily
- Includes: 5" resilient rubber casters (two swivel, two with brake)
- One year limited warranty
- Shipped knocked down
- NSF Certified



**800 - LBS
CAPACITY**
Evenly Distributed



| Model No. | Dimensions W" x D" x H" | Wt. lbs. |
|-----------|-------------------------|----------|
|-----------|-------------------------|----------|

4 SHELVES

| | | |
|--------------|--------------|-------|
| RL914 | 30 x 14 x 60 | 47 |
| RL915 | 36 x 14 x 60 | 51.9 |
| RL916 | 48 x 14 x 60 | 69.15 |
| RL917 | 60 x 14 x 60 | 71.8 |

| Model No. | Dimensions W" x D" x H" | Wt. lbs. |
|-----------|-------------------------|----------|
|-----------|-------------------------|----------|

5 SHELVES

| | | |
|--------------|--------------|-------|
| RL918 | 30 x 14 x 60 | 53.2 |
| RL919 | 36 x 14 x 60 | 59.3 |
| RL920 | 48 x 14 x 60 | 68.35 |
| RL921 | 60 x 14 x 60 | 84.2 |

WIRE SHELF CARTS

- Open-wire shelf design minimizes dust and increases air circulation and visibility
- High quality chromate plated shelves and posts prevent corrosion
- Shelves can be adjusted quickly and easily
- Strong and versatile
- Includes: 5" resilient rubber casters (two swivel, two with brake)
- One year limited warranty
- Shipped knocked down
- NSF Certified

**800 - LB.
CAPACITY**
Evenly Distributed



| Model No. | Dimensions W" x D" x H" | Wt. lbs. |
|-----------|-------------------------|----------|
|-----------|-------------------------|----------|

4 SHELVES

| | | |
|--------------|--------------|-------|
| RL600 | 36 x 18 x 69 | 56.75 |
| RL601 | 48 x 18 x 69 | 62.5 |
| RL602 | 60 x 18 x 69 | 80.4 |
| RL603 | 36 x 24 x 69 | 64.9 |
| RL604 | 48 x 24 x 69 | 78.5 |
| RL605 | 60 x 24 x 69 | 92.4 |
| MJ527 | 36 x 18 x 80 | 58.4 |
| MJ528 | 48 x 18 x 80 | 64.1 |
| MJ529 | 60 x 18 x 80 | 82 |
| MJ530 | 36 x 24 x 80 | 66.5 |
| MJ531 | 48 x 24 x 80 | 80 |
| MJ532 | 60 x 24 x 80 | 94 |

5 SHELVES

| | | |
|--------------|--------------|------|
| MJ533 | 36 x 18 x 92 | 70.5 |
| MJ534 | 48 x 18 x 92 | 77.6 |
| MJ535 | 60 x 18 x 92 | 100 |
| MJ536 | 36 x 24 x 92 | 80.6 |
| MJ537 | 48 x 24 x 92 | 97.6 |
| MJ538 | 60 x 24 x 92 | 115 |

WIRE SHELVING WITH STORAGE BINS

WIRE SHELVING UNITS WITH STORAGE BINS

- Adjustable chromate wire shelves
- Wire shelving resists corrosion and provides greater visibility to stored parts
- Wire shelves prevent build up of dust and dirt
- Bins are unaffected by oil, alkaline, and most acids
- Ideal in production or for parts storage
- Total unit capacity should not exceed 2000 lbs.
- Assembly required



RL815



RL820



RL826



| Model No. | Shelving Size D" x W" x H" | No. of Shelves | Bin Model No.* | No. of Bins | Colour |
|-----------|-------------------------------|----------------|---------------------|-------------|--------|
| RL815 | 14 x 36 x 74 | 8 | CB264 | 28 | Blue |
| RL816 | 14 x 36 x 74 | 8 | CB265 | 28 | Yellow |
| RL817 | 14 x 36 x 74 | 8 | CC236 | 28 | Green |
| RL818 | 14 x 36 x 74 | 8 | CC244 | 28 | Red |
| RL819 | 18 x 36 x 74 | 8 | CC239 | 28 | Blue |
| RL820 | 18 x 36 x 74 | 8 | CC240 | 28 | Yellow |
| RL821 | 18 x 36 x 74 | 8 | CC237 | 28 | Green |
| RL822 | 18 x 36 x 74 | 8 | CC245 | 28 | Red |
| RL823 | 24 x 36 x 74 | 5 | CF328 | 8 | Blue |
| RL824 | 24 x 36 x 74 | 5 | CF330 | 8 | Yellow |
| RL825 | 24 x 36 x 74 | 5 | CF329 | 8 | Green |
| RL826 | 24 x 36 x 74 | 5 | CF327 | 8 | Red |
| RL827 | 18 x 48 x 74 | 8 | CC239, CB266 | 28, 7 | Blue |
| RL828 | 18 x 48 x 74 | 8 | CC240, CB267 | 28, 7 | Yellow |
| RL829 | 18 x 48 x 74 | 8 | CC237, CC238 | 28, 7 | Green |
| RL830 | 18 x 48 x 74 | 8 | CC245, CC246 | 28, 7 | Red |
| RL831 | 18 x 48 x 74 | 8 | CC239, CB266 | 7, 21 | Blue |
| RL832 | 18 x 48 x 74 | 8 | CC240, CB267 | 7, 21 | Yellow |
| RL833 | 18 x 48 x 74 | 8 | CC237, CC238 | 7, 21 | Green |
| RL834 | 18 x 48 x 74 | 8 | CC245, CC246 | 7, 21 | Red |
| RL835 | 24 x 48 x 74 | 5 | CC239, CB266, CF328 | 4, 7, 6 | Blue |
| RL836 | 24 x 48 x 74 | 5 | CC240, CB267, CF330 | 4, 7, 6 | Yellow |
| RL837 | 24 x 48 x 74 | 5 | CC237, CC238, CF329 | 4, 7, 6 | Green |
| RL838 | 24 x 48 x 74 | 5 | CC245, CC246, CF327 | 4, 7, 6 | Red |
| RL839 | 18 x 36 x 74 | 8 | CB266, CC239 | 14, 7 | Blue |
| RL840 | 18 x 36 x 74 | 8 | CB267, CC240 | 14, 7 | Yellow |
| RL841 | 18 x 36 x 74 | 8 | CC238, CC237 | 14, 7 | Green |
| RL842 | 18 x 36 x 74 | 8 | CC246, CC245 | 14, 7 | Red |

* See Page 27 for bin dimensions

SLANTED & BASKET WIRE SHELVING

SLANTED WIRE SHELVING UNIT

- Slanted shelving allows for better visibility of stored items
- Includes 3 or 5 slanted shelves and 2 flat shelves
- Kit Type: Starter
- Shelf Capacity: 400 lbs.
- Overall Capacity: 1000 lbs.
- NSF Certified

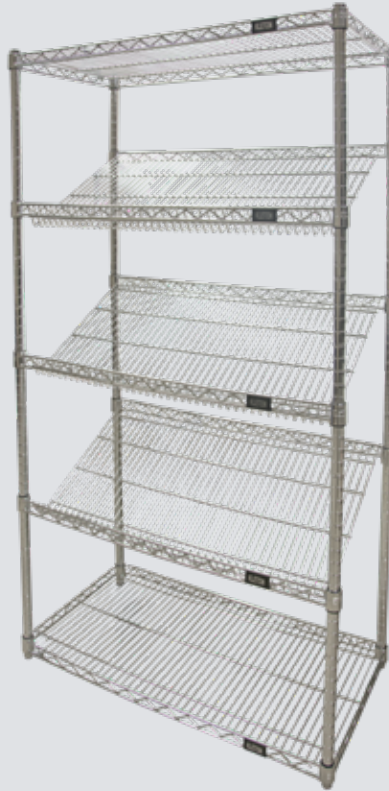

| Model No. | Dimensions D" x W" x H" | No. of Shelves |
|-----------|-------------------------|----------------|
| RN589 | 18 x 36 x 63 | 5 |
| RN590 | 18 x 48 x 63 | 5 |
| RN591 | 24 x 48 x 63 | 5 |
| RN592 | 18 x 36 x 74 | 7 |
| RN593 | 18 x 48 x 74 | 7 |
| RN594 | 24 x 48 x 74 | 7 |

WIRE BASKET SHELVING UNIT

- Basket shelves help to keep items organized and visible, while preventing items from falling off the shelves
- Open wire provides optimal airflow and helps to reduce dust
- Kit Type: Starter
- Shelf Capacity: 400 lbs.
- Overall Capacity: 1000 lbs.
- NSF Certified
- Includes 5 wire basket shelves



| Model No. | Dimensions W" x D" x H" | No. of Baskets |
|-----------|-------------------------|----------------|
| RN609 | 18 x 36 x 74 | 5 |
| RN610 | 18 x 48 x 74 | 5 |
| RN611 | 24 x 48 x 74 | 5 |

SLANTED & BASKET WIRE SHELVING

SLANTED SHELF CARTS

- Slanted shelving allows for better visibility of stored items
- Includes: (3) or (5) slanted shelves, (2) flat shelves, (2) swivel casters, (2) rigid casters
- Kit Type: Starter
- Shelf Capacity: 400 lbs.
- Overall Capacity: 800 lbs.
- NSF Certified

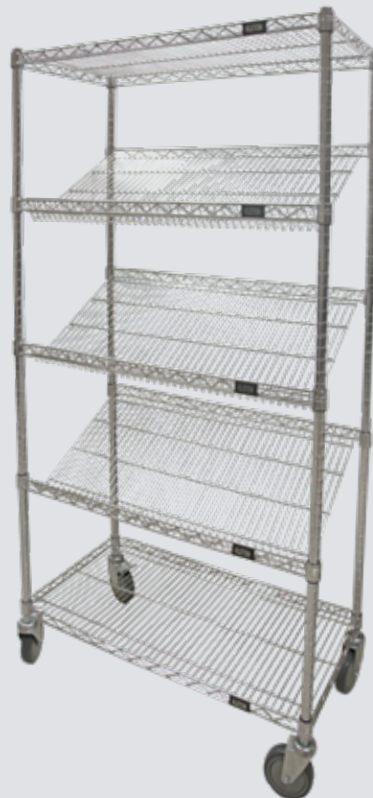

| Model No. | Dimensions D" x W" x H" | No. of Shelves |
|-----------|----------------------------|----------------|
| RN595 | 18 x 36 x 69 | 5 |
| RN596 | 18 x 48 x 69 | 5 |
| RN597 | 24 x 48 x 69 | 5 |
| RN598 | 18 x 36 x 80 | 7 |
| RN599 | 18 x 48 x 80 | 7 |
| RN600 | 24 x 48 x 80 | 7 |

WIRE BASKET SHELF CARTS

- Basket shelves help to keep items organized and visible, while preventing items from falling off the shelves
- Includes: (5) basket shelves, (2) swivel casters, (2) rigid casters
- Kit Type: Starter
- Shelf Capacity: 400 lbs.
- Overall Capacity: 800 lbs.
- No. of Baskets: 5
- NSF Certified



| Model No. | Dimensions D" x W" x H" | No. of Baskets |
|-----------|----------------------------|----------------|
| RN612 | 36 x 18 x 80 | 5 |
| RN613 | 48 x 18 x 80 | 5 |
| RN614 | 48 x 24 x 80 | 5 |

WIRE MESH CARTS

SLANTED WIRE SHELF CART WITH BINS

- Slanted shelving allows for better visibility of stored items
- Features: 3 slanted shelves, 2 flat shelves, (2) swivel casters with brakes, (2) swivel casters with no brakes
- Kit Type: Starter
- Shelf Capacity: 400 lbs.
- Overall Capacity: 800 lbs.
- No. of Shelves: 5
- NSF Certified



| Model No. | Overall Height" | Overall Width" | Overall Depth" | No. of Bins | Bin Colour |
|-----------|-----------------|----------------|----------------|-------------|------------|
| RN601 | 69 | 36 | 18 | 16 | Blue |
| RN602 | 69 | 36 | 18 | 16 | Yellow |
| RN603 | 69 | 36 | 18 | 16 | Green |
| RN604 | 69 | 36 | 18 | 16 | Red |
| RN605 | 69 | 48 | 18 | 20 | Blue |
| RN606 | 69 | 48 | 18 | 20 | Yellow |
| RN607 | 69 | 48 | 18 | 20 | Green |
| RN608 | 69 | 48 | 18 | 20 | Red |

SLANTED WIRE SHELF WITH BINS

- Slanted shelving allows for better visibility of stored items
- Features 3 slanted shelves, 2 flat shelves
- Kit Type: Starter
- Shelf Capacity: 400 lbs.
- Overall Capacity: 1000 lbs.
- No. of Shelves: 5
- NSF Certified

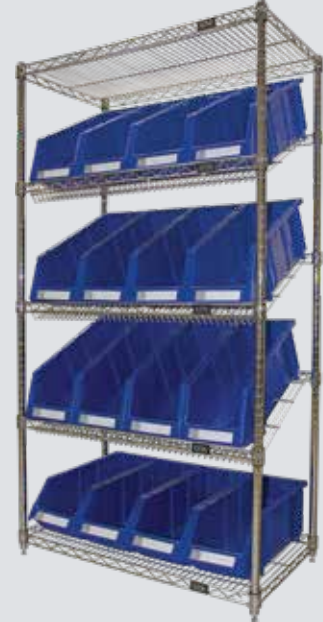

| Model No. | Overall Height" | Overall Width" | Overall Depth" | No. of Bins | Bin Colour |
|-----------|-----------------|----------------|----------------|-------------|------------|
| RN658 | 63 | 36 | 18 | 16 | Blue |
| RN659 | 63 | 36 | 18 | 16 | Yellow |
| RN660 | 63 | 36 | 18 | 16 | Green |
| RN661 | 63 | 36 | 18 | 16 | Red |
| RN662 | 63 | 48 | 18 | 20 | Blue |
| RN663 | 63 | 48 | 18 | 20 | Yellow |
| RN664 | 63 | 48 | 18 | 20 | Green |
| RN665 | 63 | 48 | 18 | 20 | Red |

ENCLOSED WIRE STOCK PICKING CARTS

- High quality chromate shelves and posts prevent corrosion
- Enclosed sides keeps items from falling out
- Shelves can be adjusted quickly and easily
- Strong and versatile
- Includes: (2) 5" swivel resilient casters, (2) 5" rubber caster with brakes
- Shipped knocked down
- One-year limited warranty
- Capacity is based on evenly distributed weight
- No. of Shelves: 4
- Capacity: 800 lbs.
- Cart Material: Chrome Plated
- NSF Certified

| Model No. | Overall Width" | Overall Height" | Overall Depth" |
|-----------|----------------|-----------------|----------------|
| RN559 | 36 | 69 | 18 |
| RN560 | 48 | 69 | 18 |
| RN561 | 60 | 69 | 18 |
| RN562 | 36 | 69 | 24 |
| RN563 | 48 | 69 | 24 |
| RN564 | 60 | 69 | 24 |

WIRE ENCLOSURE PANELS

| Model No. | Dimensions W" x H" |
|-----------|--------------------|
| RN556 | 15 x 61.5 |
| RN557 | 18 x 61.5 |
| RN558 | 21 x 61.5 |

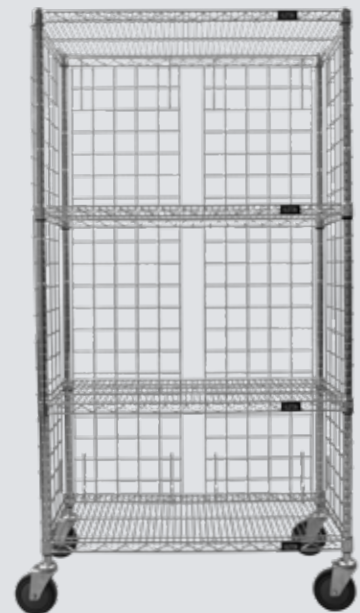

- IDEAL FOR STORING SUPPLIES IN WAREHOUSES OR SHOPS
- BOLTLESS SHELVING SYSTEM CAN BE BUILT QUICKLY AND EASILY

GREEN EPOXY FINISH WIRE SHELVING

GREEN EPOXY FINISH WIRE SHELVING COMPONENTS

- Ideal for use in wet environments
- Superior rust resistance
- Designed to minimize dust, improve air circulation, and provide greater visibility of stored items
- Post's circular grooves combined with tapered plastic sleeves allow for assembly in minutes with no special tools
- Shelf ribs run front to back allowing items to slide on and off shelves smoothly
- Shelves can be adjusted at precise 1" intervals
- Posts are double grooved every 8" and numbered for easy adjustment
- Adjustable feet compensate for surface irregularities
- Stationary unit's total capacity should not exceed 2000 lbs.
- Shipped knocked down
- NSF Certified



WIRE SHELVES

| Model No. | D" x W" | Cap lbs. Shelf* |
|-----------|---------|-----------------|
| RN082 | 14 x 30 | 800 |
| RN083 | 14 x 36 | 800 |
| RN084 | 14 x 48 | 800 |
| RN085 | 14 X 60 | 600 |
| RN086 | 14 x 72 | 600 |
| RN087 | 18 x 30 | 800 |
| RL622 | 18 x 36 | 800 |
| RL623 | 18 x 48 | 800 |
| RL624 | 18 x 60 | 600 |
| RL625 | 18 x 72 | 600 |
| RL626 | 24 x 36 | 800 |
| RL627 | 24 x 48 | 800 |
| RL628 | 24 x 60 | 600 |
| RN077 | 24 x 72 | 600 |

*Evenly distributed weight

POSTS

| Model No. | Height" |
|-----------|---------|
| RL629 | 63 |
| RL630 | 74 |
| RL631 | 86 |

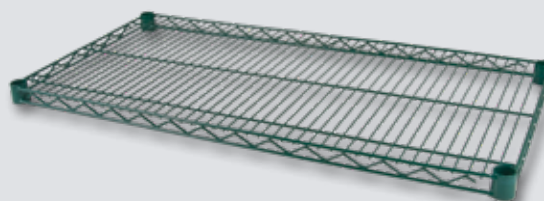

GREEN EPOXY FINISH WIRE SHELF CARTS

800 - LB. CAPACITY
Evenly Distributed

- Green epoxy wire shelf carts are ideal for use in wet environments
- Superior rust resistance
- Designed to minimize dust, improve air circulation, and provide greater visibility of stored items
- Shelves can be adjusted quickly and easily
- Strong and versatile
- Includes: 5" resilient rubber casters, two swivel, two with brake
- NSF certified
- One year limited warranty
- Shipped knocked down

4 SHELVES

| Model No. | Dimensions D" x W" x H" | Wt. lbs. |
|-----------|-------------------------|----------|
| RN129 | 18 x 36 x 69 | 57 |
| RN130 | 18 x 48 x 69 | 68 |
| RN131 | 18 x 60 x 69 | 84 |
| RN132 | 24 x 36 x 69 | 71 |
| RN133 | 24 x 48 x 69 | 83 |
| RN134 | 24 x 60 x 69 | 91 |
| RL803 | 18 x 36 x 80 | 59 |
| RL804 | 18 x 48 x 80 | 71 |
| RL805 | 18 x 60 x 80 | 86 |
| RL806 | 24 x 36 x 80 | 74 |
| RL807 | 24 x 48 x 80 | 85 |
| RL808 | 24 x 60 x 80 | 93 |

5 SHELVES

| Model No. | Dimensions D" x W" x H" | Wt. lbs. |
|-----------|-------------------------|----------|
| RL809 | 18 x 36 x 92 | 70 |
| RL810 | 18 x 48 x 92 | 85 |
| RL811 | 18 x 60 x 92 | 104 |
| RL812 | 24 x 36 x 92 | 89 |
| RL813 | 24 x 48 x 92 | 103 |
| RL814 | 24 x 60 x 92 | 113 |



GREEN EPOXY WIRE SHELVING AND COAT RACK SHELVING

WIRE SHELF PUSH CART



- Capacity is based on evenly distributed weight
- Features 24" Green Epoxy Handle for improved maneuverability
- Green epoxy wire shelf carts are ideal for use in wet environments
- Superior rust resistance
- Designed to minimize dust, improve air circulation and provide greater visibility of stored items
- Shelves can be adjusted quickly and easily
- Includes: (1) 24" Green epoxy handle, (2) 5" Swivel resilient rubber casters, (2) 5" Resilient rubber casters with brakes
- Shipped knocked-down
- NSF certified

RN798



| Model No. | No. of Shelves | Capacity lbs. | Overall Width" | Overall Depth" | Overall Height" | Cart Material | Wheel Material |
|-----------|----------------|---------------|----------------|----------------|-----------------|---------------|----------------|
| RN798 | 4 | 800 | 36 | 24 | 69 | Epoxy Finish | Rubber |
| RN799 | 4 | 800 | 48 | 24 | 69 | Epoxy Finish | Rubber |
| RN800 | 4 | 800 | 60 | 24 | 69 | Epoxy Finish | Rubber |
| RN801 | 5 | 800 | 36 | 24 | 69 | Epoxy Finish | Rubber |
| RN802 | 5 | 800 | 48 | 24 | 69 | Epoxy Finish | Rubber |
| RN803 | 5 | 800 | 60 | 24 | 69 | Epoxy Finish | Rubber |

CANNABIS DRY RACK SHELVING



- 3" wire spacing ideal for drying produce
- Superior rust resistance
- Designed to minimize dust, improve air circulation and provide greater visibility of stored items
- Posts's circular grooves combined with tapered plastic sleeves allow for assembly in minutes with no special tools
- Shelves can be adjusted at precise 1" intervals
- Posts are double grooved every 8" and numbered for easy adjustment
- Adjustable feet compensate for surface irregularities
- Stationary unit's total capacity should not exceed 400 lbs.
- Green epoxy wire shelving is ideal for use in wet environments
- NSF certified

RN780



| Model No. | No. of Shelves | Kit Type | Shelf Capacity lbs. | Overall Width" | Overall Depth" | Overall Height" | Material | Total Capacity lbs |
|-----------|----------------|----------|---------------------|----------------|----------------|-----------------|-------------|--------------------|
| RN780 | 4 | Starter | 100 | 36 | 18 | 69 | Green Epoxy | 400 |
| RN781 | 4 | Starter | 100 | 48 | 18 | 69 | Green Epoxy | 400 |
| RN782 | 4 | Starter | 100 | 60 | 18 | 69 | Green Epoxy | 400 |

WIRE GARMENT RACK



- Garment rack on wheels helps to maximize space
- Two 36" shelves are perfect for storing hats and shoes
- Hanging bar holds up to 50 jackets
- Shelf Capacity 500 lbs.
- Overall Capacity: 800 lbs.
- Dimensions: 36" W x 18" D x 69" H
- No. of Shelves: 2
- Kit Type: Starter
- NSF certified

RN797



Model No. **RN797**

- IDEAL FOR USE IN WET ENVIRONMENTS
- PERFECT FOR STORING SUPPLIES IN WAREHOUSES OR SHOPS
- NO BOLT SHELVING SYSTEM CAN BE BUILT QUICKLY AND EASILY

GREEN EPOXY FINISH WIRE SHELVING



RL648

GREEN EPOXY FINISH WIRE SHELVING

- Superior rust resistance
- Designed to minimize dust, improve air circulation, and provide greater visibility of stored items
- Post's circular grooves combined with tapered plastic sleeves allow for assembly in minutes with no special tools
- Shelf ribs run front to back allowing items to slide on and off shelves smoothly
- Shelves can be adjusted at precise 1" intervals
- Posts are double grooved every 8" and numbered for easy adjustment
- Adjustable feet compensate for surface irregularities
- Stationary unit's total capacity should not exceed 2000 lbs.
- Shipped knocked down
- NSF Certified

4 SHELVES

| Model No. | Type | Dimensions D" x W" x H" | Cap lbs. Shelf |
|-----------|---------|-------------------------|----------------|
| RN089 | Starter | 14 x 30 x 63 | 800 |
| RN090 | Add-on | 14 x 30 x 63 | 800 |
| RN091 | Starter | 14 x 36 x 63 | 800 |
| RN092 | Add-on | 14 x 36 x 63 | 800 |
| RN093 | Starter | 14 x 48 x 63 | 800 |
| RN094 | Add-on | 14 x 48 x 63 | 800 |
| RN095 | Starter | 14 x 60 x 63 | 600 |
| RN096 | Add-on | 14 x 60 x 63 | 600 |
| RN097 | Starter | 14 x 72 x 63 | 600 |
| RN098 | Add-on | 14 x 72 x 63 | 600 |
| RL648 | Starter | 18 x 36 x 63 | 800 |
| RL649 | Add-on | 18 x 36 x 63 | 800 |
| RL650 | Starter | 18 x 48 x 63 | 800 |
| RL651 | Add-on | 18 x 48 x 63 | 800 |
| RL652 | Starter | 18 x 60 x 63 | 600 |
| RL653 | Add-on | 18 x 60 x 63 | 600 |
| RL654 | Starter | 18 x 72 x 63 | 600 |
| RL655 | Add-on | 18 x 72 x 63 | 600 |
| RL656 | Starter | 24 x 36 x 63 | 800 |
| RL657 | Add-on | 24 x 36 x 63 | 800 |
| RL658 | Starter | 24 x 48 x 63 | 800 |
| RL659 | Add-on | 24 x 48 x 63 | 800 |
| RL660 | Starter | 24 x 60 x 63 | 600 |
| RL661 | Add-on | 24 x 60 x 63 | 600 |
| RN099 | Starter | 24 x 72 x 63 | 600 |
| RN100 | Add-on | 24 x 72 x 63 | 600 |

*Evenly distributed weight

5 SHELVES

| Model No. | Type | Dimensions D" x W" x H" | Cap lbs. Shelf |
|-----------|---------|-------------------------|----------------|
| RN101 | Starter | 14 x 30 x 74 | 800 |
| RN102 | Add-on | 14 x 30 x 74 | 800 |
| RN103 | Starter | 14 x 36 x 74 | 800 |
| RN104 | Add-on | 14 x 36 x 74 | 800 |
| RN105 | Starter | 14 x 48 x 74 | 800 |
| RN106 | Add-on | 14 x 48 x 74 | 800 |
| RN107 | Starter | 14 x 60 x 74 | 600 |
| RN108 | Add-on | 14 x 60 x 74 | 600 |
| RN109 | Starter | 14 x 72 x 74 | 600 |
| RN110 | Add-on | 14 x 72 x 74 | 600 |
| RL662 | Starter | 18 x 36 x 74 | 800 |
| RL663 | Add-on | 18 x 36 x 74 | 800 |
| RN113 | Starter | 18 x 36 x 86 | 800 |
| RN114 | Add-on | 18 x 36 x 86 | 800 |
| RL664 | Starter | 18 x 48 x 74 | 800 |
| RL665 | Add-on | 18 x 48 x 74 | 800 |
| RN115 | Starter | 18 x 48 x 86 | 800 |
| RN116 | Add-on | 18 x 48 x 86 | 800 |
| RL666 | Starter | 18 x 60 x 74 | 600 |
| RL667 | Add-on | 18 x 60 x 74 | 600 |
| RN117 | Starter | 18 x 60 x 86 | 600 |
| RN118 | Add-on | 18 x 60 x 86 | 600 |
| RL668 | Starter | 18 x 72 x 74 | 600 |
| RL669 | Add-on | 18 x 72 x 74 | 600 |
| RN119 | Starter | 18 x 72 x 86 | 600 |
| RN120 | Add-on | 18 x 72 x 86 | 600 |
| RL670 | Starter | 24 x 36 x 74 | 800 |
| RL671 | Add-on | 24 x 36 x 74 | 800 |
| RN121 | Starter | 24 x 36 x 86 | 800 |
| RN122 | Add-on | 24 x 36 x 86 | 800 |
| RL672 | Starter | 24 x 48 x 74 | 800 |
| RL673 | Add-on | 24 x 48 x 74 | 800 |
| RN123 | Starter | 24 x 48 x 86 | 800 |
| RN124 | Add-on | 24 x 48 x 86 | 800 |
| RL674 | Starter | 24 x 60 x 74 | 600 |
| RL675 | Add-on | 24 x 60 x 74 | 600 |
| RN125 | Starter | 24 x 60 x 86 | 600 |
| RN126 | Add-on | 24 x 60 x 86 | 600 |
| RN111 | Starter | 24 x 72 x 74 | 600 |
| RN112 | Add-on | 24 x 72 x 74 | 600 |
| RN127 | Starter | 24 x 72 x 86 | 600 |
| RN128 | Add-on | 24 x 72 x 86 | 600 |

*Evenly distributed weight

WIDE SPAN SHELVING

WIDE SPAN SHELVING WITH JUMBO PLASTIC BINS

- 12-gauge steel posts and 13-gauge beams
- Shelf levels include 5/8" particleboard decking and required tie bars
- Capacity is 800 lbs. per shelf (based on evenly distributed loads)
- Offered configurations include three levels with 12 bins and four levels with 16 bins.
- Plastic bin outside dimensions :15-1/2" W x 25" D x 13" H
- Assembly required



RL986



RL984



| Model No. | Shelving Size D" x W" x H" | No. of Shelves | No. of Bins | Colour |
|-----------|----------------------------|----------------|-------------|--------------------------|
| RL984 | 18 x 66 x 60 | 3 | 12 | Red |
| RL985 | 18 x 66 x 60 | 3 | 12 | Blue |
| RL986 | 18 x 66 x 60 | 3 | 12 | Green |
| RL987 | 18 x 66 x 60 | 3 | 12 | Yellow |
| RL988 | 18 x 66 x 60 | 3 | 12 | Red, Blue, Yellow |
| RL980 | 18 x 66 x 72 | 4 | 16 | Red |
| RL981 | 18 x 66 x 72 | 4 | 16 | Blue |
| RL982 | 18 x 66 x 72 | 4 | 16 | Green |
| RL983 | 18 x 66 x 72 | 4 | 16 | Yellow |
| RL989 | 18 x 66 x 72 | 4 | 16 | Red, Blue, Yellow, Green |

HEAVY-DUTY BOLTLESS SHELVING

- Modular design allows the unit to be set up as a shelving unit or as work bench
- Includes five Medium-Density Fiberboard (MDF) shelves
- Shelves snap into place quickly and easily
- Shelf capacity: 1200 lbs.



| Model No. | Dimensions D" x W" x H" |
|-----------|-------------------------|
|-----------|-------------------------|

5 SHELVES

| | |
|-------|--------------|
| RN455 | 18 x 36 x 72 |
| RN456 | 24 x 36 x 72 |
| RN457 | 18 x 48 x 72 |
| RN458 | 24 x 48 x 72 |

3 SHELVES

| | |
|-------|--------------|
| RN806 | 36 x 48 x 84 |
| RN807 | 24 x 48 x 84 |
| RN808 | 24 x 72 x 84 |
| RN809 | 24 x 96 x 84 |



HEAVY-DUTY STEEL SHELVING

- Excellent for storing heavy materials
- Open style shelving gives clear access from all sides
- Shelf capacity of 3000 lbs based on evenly distributed loads
- Ships knocked down
- Grey powder coat finish
- No. of shelves: 5
- Kit Type: Starter
- Style: Open
- Material: Steel

5 SHELF

| Model No. | Dimensions W" x D" x H" |
|-----------|----------------------------|
| RN772 | 36 x 18 x 72 |
| RN773 | 48 x 18 x 72 |
| RN774 | 60 x 18 x 72 |
| RN775 | 36 x 24 x 72 |
| RN776 | 48 x 24 x 72 |
| RN777 | 60 x 24 x 72 |



HEAVY-DUTY INDUSTRIAL CARROUSEL DRAWER CABINETS

CREATE YOUR CUSTOMIZED CARROUSEL CABINET

- Each level accommodates 4 parts cabinets with same height
- For a multiple tier cabinet (maximum 3 tiers), you require add-on-shelves and threaded rods as per the following: 1 add-on-shelf **CF402** for each level of cabinets, 14" rod required for each level of **CF312** or **CF305** cabinets 25" rod required for each level of **CC453** or **CF314** cabinets
- Rotating base allows for 800-lb. capacity
- All-welded 11-gauge steel base
- Durable KLETON grey enamel finish

| Model No. | Description | Dimensions W" x D" x H" | Wt. lbs. |
|--------------|-----------------------------|-------------------------|----------|
| CF401 | Rotating Base and Top Cover | 27-1/2 x 27-1/2 x 4 | 72 |
| CF402 | Add-on Shelf | 27-1/2 x 27-1/2 x 1 | 21 |
| CF403 | Threaded Rod - 14" | 3/8 x 14 | 0.5 |
| CF404 | Threaded Rod - 25" | 3/8 x 25 | 0.8 |
| CF305 | Parts Cabinet - 16 Drawers | 18-5/16 x 8-11/16 x 14 | 23 |
| CF312 | Parts Cabinet - 20 Drawers | 18-5/16 x 8-11/16 x 14 | 24 |
| CC453 | Parts Cabinet - 32 Drawers | 18-5/16 x 8-11/16 x 25 | 31.4 |
| CF314 | Parts Cabinet - 40 Drawers | 18-5/16 x 8-11/16 x 25 | 40 |



CF408
Includes:
Qty: 12 - CF314 - Cabinet - 40 drawers
Qty: 1 - CF401 - Rotating Base and Top Cover
Qty: 2 - CF404 - Threaded Rod 25"
Qty: 2 - CF042 - Add-on Shelf

3 TIER CABINET KITS

CF405 - 192 DRAWERS

Includes:

- 12 - **CF305** Parts Cabinets
- 1 - **CF401** Rotating Base and Top Cover
- 2 - **CF402** Add-on Shelf
- 3 - **CF403** Threaded Rods 14"



CF406 - 240 DRAWERS

Includes:

- 12 - **CF312** Parts Cabinets
- 1 - **CF401** Rotating Base and Top Cover
- 2 - **CF402** Add-on Shelf
- 3 - **CF403** Threaded Rods 14"



CF407 - 384 DRAWERS

Includes:

- 12 - **CC453** Parts Cabinets
- 1 - **CF401** Rotating Base and Top Cover
- 2 - **CF402** Add-on Shelf
- 3 - **CF404** Threaded Rods 25"



CF408 - 480 DRAWERS

Includes:

- 12 - **CF314** Parts Cabinets
- 1 - **CF401** Rotating Base and Top Cover
- 2 - **CF402** Add-on Shelf
- 3 - **CF404** Threaded Rods 25"



| Model No. | Description | Dimensions W" x D" x H" | Wt. lbs. |
|--------------|-------------|-------------------------|----------|
| CF405 | 192 Drawers | 27 x 27 x 48 | 388 |
| CF406 | 240 Drawers | 27 x 27 x 48 | 403 |
| CF407 | 384 Drawers | 27 x 27 x 80 | 492 |
| CF408 | 480 Drawers | 27 x 27 x 80 | 595 |



KPC-HD HEAVY-DUTY PARTS CABINETS

- Reinforced heavy-duty steel shelves provide extra durability
- Drawer size: 6-1/2" W x 14-13/16" D x 4-1/8" H
- New design allows 98% use of drawer space to store larger tools or materials
- Housed in all-welded galvanized steel cabinet
- Label with clear plastic cover and divider included with every drawer
- Grey enamel finish
- Heavy-duty ABS grey drawers

| Model No. | No. of Drawers | Cabinet Size W" x D" x H" | Wt. lbs. |
|-----------|----------------|----------------------------|----------|
| CF323 | 30 | 34-5/8 x 15-11/16 x 34-5/8 | 83 |

REPLACEMENT PARTS

- Model No. **CF324**, Drawer
 Model No. **CF546**, Black Divider
 Model No. **CF343**, Label Cover
 Model No. **CF344**, Label

CF323



KPC-100 PARTS CABINETS

- Drawer size: 6-3/8" W x 11-5/16" D x 2-11/16" H
- New design allows 98% use of drawer space to store larger tools or materials
- Housed in all-welded galvanized steel cabinet
- Label with clear plastic cover and divider included with every drawer
- Plastic tabs and drawer stoppers allow for full extension without risk of spilling
- Grey enamel finish
- Heavy-duty ABS grey drawers

| Model No. | No. of Drawers | Cabinet Size W" x D" x H" | Wt. lbs. |
|-----------|----------------|---------------------------|----------|
| CF283 | 12 | 23 x 11-3/8 x 13-13/16 | 28 |
| CF285 | 36 | 23 x 11-3/8 x 36-7/8 | 60 |

REPLACEMENT PARTS

- Model No. **CF286**, Drawer
 Model No. **CF287**, Clear Divider
 Model No. **CF545**, Black Divider
 Model No. **CF341**, Label Cover
 Model No. **CC310**, Label

CF285



CF283

KPC-200 PARTS CABINETS

- Drawer size: 5-7/8" W x 9-13/16" D x 3-5/16" H
- New design allows 98% use of drawer space to store larger tools or materials
- Housed in all-welded galvanized steel cabinet
- Label with clear plastic cover and divider included with every drawer
- Plastic tabs and drawer stoppers allow for full extension without risk of spilling
- Grey enamel finish
- Heavy-duty ABS grey drawers

| Model No. | No. of Drawers | Cabinet Size W" x D" x H" | Wt. lbs. |
|-----------|----------------|---------------------------|----------|
| CA889 | 30 | 21-1/8 x 10-1/2 x 36-3/4 | 58 |

REPLACEMENT PARTS

- Model No. **CF481**, Drawer
 Model No. **CF548**, Black Divider
 Model No. **CF341**, Label Cover
 Model No. **CC310**, Label



PARTS CABINETS

KPC-400 PARTS CABINETS

- Drawer size: 4-11/16" W x 8-5/8" D x 2-11/16" H
- New design allows 98% use of drawer space to store larger tools or materials
- Housed in all-welded galvanized steel cabinet
- Label with clear plastic cover and divider included with every drawer
- Plastic tabs and drawer stoppers allow for full extension without risk of spilling
- Grey enamel finish
- Heavy-duty ABS grey drawers

| Model No. | No. of Drawers | Cabinet Size W" x D" x H" | Wt. lbs. |
|-----------|----------------|-----------------------------|----------|
| CF298 | 16 | 23-1/8 x 8-11/16 x 13-13/16 | 25 |
| CA891 | 24 | 17-5/16 x 8-11/16 x 25-5/8 | 33 |
| CA892 | 48 | 22-5/8 x 8-11/16 x 36-7/8 | 58 |
| CD440* | 48 | 22-5/8 x 10-4/5 x 36-7/8 | 78 |

* Comes with locking doors

REPLACEMENT PARTS

- Model No. **CB985**, Drawer
 Model No. **CF550**, Black Divider
 Model No. **CF341**, Label Cover
 Model No. **CC310**, Label



KPC-500 PARTS CABINETS

- Drawer size: 3-1/2" W x 8-5/8" D x 2-11/16" H
- New design allows 98% use of drawer space to store larger tools or materials
- Housed in all-welded galvanized steel cabinet
- Label with clear plastic cover and divider included with every drawer
- Plastic tabs and drawer stoppers allow for full extension without risk of spilling
- Grey enamel finish
- Clear polystyrene drawers

| Model No. | No. of Drawers | Cabinet Size W" x D" x H" | Wt. lbs. |
|-----------|----------------|------------------------------|----------|
| CF304 | 15 | 13-7/8 x 8-11/16 x 16-5/16 | 21 |
| CF305 | 16 | 18-5/16 x 8-11/16 x 13-13/16 | 23 |
| CC453 | 32 | 18-1/8 x 8-11/16 x 25-5/8 | 31 |
| CC454 | 60 | 22-5/8 x 8-11/16 x 36-7/8 | 68 |

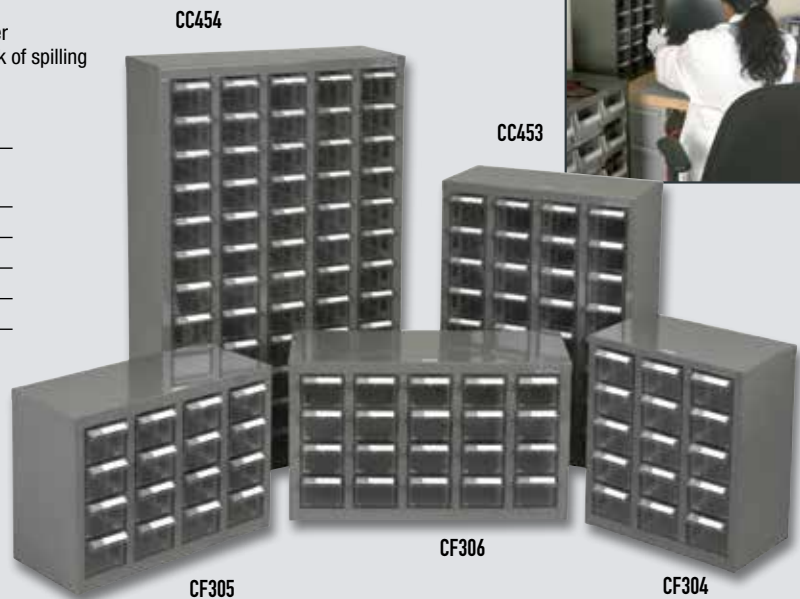

REPLACEMENT PARTS

- Model No. **CC455**, Drawer
 Model No. **CF551**, Black Divider
 Model No. **CF341**, Label Cover
 Model No. **CC310**, Label

KPC-600 PARTS CABINETS

- Drawer size: 3-1/2" W x 8-5/8" D x 2-3/16" H
- New design allows 98% use of drawer space to store larger tools or materials
- Housed in all-welded galvanized steel cabinet
- Label with clear plastic cover and divider included with every drawer
- Plastic tabs and drawer stoppers allow for full extension without risk of spilling
- Grey enamel finish
- Clear polystyrene drawers



| Model No. | No. of Drawers | Cabinet Size W" x D" x H" | Wt. lbs. |
|-----------|----------------|------------------------------|----------|
| CF311 | 18 | 13-7/8 x 8-11/16 x 16-5/16 | 20 |
| CF312 | 20 | 18-5/16 x 8-11/16 x 13-13/16 | 24 |
| CF313 | 25 | 23-1/8 x 8-11/16 x 13-13/16 | 30 |
| CF314 | 40 | 18-5/16 x 8-11/16 x 25-5/16 | 40 |
| CF315 | 75 | 23-1/8 x 8-11/16 x 36-7/8 | 72 |

REPLACEMENT PARTS

Model No. **CF316**, Drawer
 Model No. **CF552**, Black Divider
 Model No. **CF341**, Label Cover
 Model No. **CC310**, Label

KPC-700 PARTS CABINETS

- Drawer size: 4-11/16" W x 8-5/8" D x 2-3/16" H
- New design allows 98% use of drawer space to store larger tools or materials
- Housed in all-welded galvanized steel cabinet
- Label with clear plastic cover and divider included with every drawer
- Plastic tabs and drawer stoppers allow for full extension without risk of spilling
- Grey enamel finish
- Clear polystyrene drawers



| Model No. | No. of Drawers | Cabinet Size W" x D" x H" | Wt. lbs. |
|-----------|----------------|---------------------------|----------|
| CF318 | 20 | 23-1/8 x 8-11/16 x 13-5/8 | 27 |
| CF320 | 60 | 23-1/8 x 8-11/16 x 36-7/8 | 71 |

REPLACEMENT PARTS

Model No. **CF321**, Drawer
 Model No. **CF553**, Black Divider
 Model No. **CF341**, Label Cover
 Model No. **CC310**, Label

STORAGE CABINETS



FB024

DEEP DOOR STORAGE CABINETS

- All-welded heavy-duty 16-gauge deep door steel cabinet
- Four reinforced 16-gauge adjustable cabinet shelves with 500-lb capacity per shelf
- 4" deep doors for maximum storage capacity
- 12 adjustable door shelves with 35-lb capacity per shelf
- Unique padlock hasp helps prevent access with bolt cutters
- Powder coat KLETON grey finish
- Padlock sold separately (See below)

| Model No. | Description | Dimension W" x D" x H" | Wt. lbs. |
|-----------|-------------------------|------------------------|----------|
| FB024 | Cabinet | 38 x 24 x 72 | 315 |
| FB025 | Extra Shelf for Cabinet | 38 x 17 x 1 | 18 |
| FB026 | Extra Shelf for Door | 18 x 6 x 1/2 | 2 |



CB448

84-BIN - DEEP DOOR COMBINATION CABINETS

- All-welded heavy-duty 16-gauge deep door, combination bin/shelf cabinet
- Four reinforced 16-gauge main adjustable shelves with 500-lb capacity per shelf
- Incorporates louvered bin hanging panels welded into the cabinets 4" deep hinged doors
- Unique padlock hasp helps prevent access with bolt cutters
- Powder coat KLETON grey finish
- Padlock sold separately (See Below)

CABINET ONLY

| Model No. | Description | Dimension W" x D" x H" | Wt. lbs. |
|-----------|-------------------------|------------------------|----------|
| CB442 | Cabinet Only | 38 x 24 x 72 | 324 |
| FB025 | Extra Shelf for Cabinet | 38 x 17 x 1 | 18 |

CABINETS WITH BINS

| Model No. | Bin Colour | Wt. lbs. | Each Cabinet Comes Complete with the Following Bins: |
|-----------|------------|----------|--|
| CB446 | Blue | 341 | |
| CB477 | Red | 341 | 84 - 4-1/8" x 5-3/8" x 3" (10 lb. Capacity) |
| CB448 | Yellow | 341 | |
| CB693 | Green | 341 | |

ACCESSORIES

PADLOCKS

| Model No. | Description |
|-----------|-------------------------|
| SA898 | Padlock Keyed Different |
| SR892 | Padlock Keyed Alike |



MOBILE DOLLY BASE FOR DEEP STORAGE CABINETS

- Heavy-duty steel construction
- Unique "no front lip" design for use with all KLETON Deep Door Cabinets
- 4" Non-marking sandwich bolted on nylon casters, including 2 swivel with brake and 2 rigid
- 2 Component grey polyurethane paint
- Capacity: 1500 lbs.
- Dimensions: 24"W x 38"D x 7"H

Model No. MN398





CF354

98-BIN DEEP DOOR COMBINATION CABINETS

- All-welded heavy-duty 16-gauge deep door, combination bin/shelf cabinet
- Two reinforced 16-gauge main adjustable shelves with 500-lb capacity per shelf
- Incorporates louvered bin hanging panels welded to the cabinet's back and doors
- Unique padlock hasp helps prevent access with bolt cutters
- Powder coat KLETON grey finish
- Padlock sold separately (See Below)

CABINET ONLY

| Model No. | Description | Dimensions W" x D" x H" | Wt. lbs. |
|-----------|--------------|-------------------------|----------|
| FH820 | Cabinet Only | 38 x 24 x 72 | 316 |
| FB025 | Extra Shelf | 38 x 17 x 1 | 18 |

CABINET WITH BINS

| Model No. | Bin Colour | Wt. lbs. | Each Cabinet Comes Complete with the Following Bins: Outside Dimensions: |
|-----------|------------|----------|---|
| CF355 | Blue | 385 | 48 - 4-1/8" x 5-3/8" x 3" (10-lb. Capacity) |
| CF356 | Red | 385 | 36 - 4-1/8" x 7-3/8" x 3" (10-lb. Capacity) |
| CF354 | Yellow | 385 | 8 - 8-1/4" x 14-3/4" x 7" (60-lb. Capacity) |
| CF357 | Green | 385 | 6 - 16-1/2" x 14-3/4" x 7" (75-lb. Capacity) |



CB445

118-BIN DEEP DOOR COMBINATION CABINETS

- All-welded heavy-duty 16-gauge deep door steel cabinet with 118 bins
- Incorporates louvered bin hanging panels welded to the cabinet's back and on its 4" deep hinged doors for added storage
- Unique padlock hasp helps prevent access with bolt cutters
- Powder coat KLETON grey finish
- Padlock sold separately (See Below)

CABINET ONLY

| Model No. | Description | Dimensions W" x D" x H" | Wt. lbs. |
|-----------|--------------|-------------------------|----------|
| CB441 | Cabinet Only | 38 x 24 x 72 | 316 |

CABINETS WITH BINS

| Model No. | Bin Colour | Wt. lbs. | Each Cabinet Comes Complete with the Following Bins: Outside Dimensions: |
|-----------|------------|----------|--|
| CB443 | Blue | 385 | 42 - 4-1/8" x 5-3/8" x 3" (10-lb. Capacity) |
| CB444 | Red | 385 | 42 - 4-1/8" x 7-3/8" x 3" (10-lb. Capacity) |
| CB445 | Yellow | 385 | 18 - 5-1/2" x 10-7/8" x 5" (30-lb. Capacity) |
| CB691 | Green | 385 | 12 - 8-1/4" x 14-3/4" x 7" (60-lb. Capacity) 4 - 16-1/2" x 14-3/4" x 7" (75-lb. Capacity) |

ACCESSORIES

PADLOCKS

| Model No. | Description |
|-----------|-------------------------|
| SA898 | Padlock Keyed Different |
| SR892 | Padlock Keyed Alike |



MOBILE DOLLY BASE FOR DEEP STORAGE CABINETS

- Heavy-duty steel construction
- Unique "no front lip" design for use with all KLETON Deep Door Cabinets
- 4" Non-marking sandwich bolted on nylon casters, including 2 swivel with brake and 2 rigid
- 2 Component grey polyurethane paint
- Capacity: 1500 lbs.
- Dimensions: 24"W x 38"D x 7"H

Model No. MN398



STORAGE CABINET

STORAGE CABINETS

- Designed for easy assembly
- One-piece base serves as additional shelf
- Locking handle for added security
- Compact size
- Ships knocked down
- No. of Shelves: 4
- Colour: Grey
- Material: Steel
- Assembly Type: Knocked Down



| Model No. | Shelf Capacity | Dimension W" x D" x H" |
|-----------|----------------|------------------------|
| FN425 | 100 lbs. | 30" x 15" x 66" |
| FN426 | 200 lbs. | 36" x 24" x 78" |
| FN427 | 300 lbs. | 48" x 24" x 78" |

HI-STAK PLASTIC STORAGE BINS

HI-STAK PLASTIC STORAGE BINS

- Innovative stacking design allows for greater visibility and easier access to contents
- Distortion-free from -40°C to 120°C
- Unaffected by oil, alkaline, and most acids
- Ideal in production or for parts storage

BIN DIMENSIONS: 4-13/16" W X 7-1/8" D X 3-3/16" H



| Model No. | Colour |
|-----------|-------------------------------|
| CB260 | Blue |
| CB261 | Yellow |
| CC234 | Green |
| CC242 | Red |
| CC441 | Replacement Faceplate & Label |
| CC263 | Replacement Legs |

BIN DIMENSIONS: 5-7/8" W X 9-13/16" D X 4-11/16" H



| Model No. | Colour |
|-----------|-------------------------------|
| CB262 | Blue |
| CB263 | Yellow |
| CC235 | Green |
| CC243 | Red |
| CC441 | Replacement Faceplate & Label |
| CC263 | Replacement Legs |

BIN DIMENSIONS: 8-3/16" W X 14" D X 6-3/16" H



| Model No. | Colour |
|-----------|-------------------------------|
| CB264 | Blue |
| CB265 | Yellow |
| CC236 | Green |
| CC244 | Red |
| CC443 | Replacement Faceplate & Label |
| CC437 | Replacement Legs |

BIN DIMENSIONS: 7-7/8" W X 17-11/16" D X 7" H



| Model No. | Colour |
|-----------|-------------------------------|
| CC239 | Blue |
| CC240 | Yellow |
| CC237 | Green |
| CC245 | Red |
| CC443 | Replacement Faceplate & Label |
| CC437 | Replacement Legs |

BIN DIMENSIONS: 11-13/16" W X 17-11/16" D X 7" H



| Model No. | Colour |
|-----------|-------------------------------|
| CB266 | Blue |
| CB267 | Yellow |
| CC238 | Green |
| CC246 | Red |
| CC443 | Replacement Faceplate & Label |
| CC437 | Replacement Legs |

INCLUDED FEATURES



Connector clip allows for back-to-back mounting



1" riser legs increase loading capacity and stability



Inclined faceplate with removable label and protector
CC441: 3" x 1/2"
CC443: 5-13/16" x 11"



Built-in extrusions allow side-by-side interlock



Stackable using built-in feet

ALL BINS ARE AVAILABLE IN 4 COLOURS



PLASTIC BINS

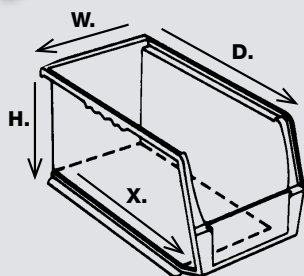
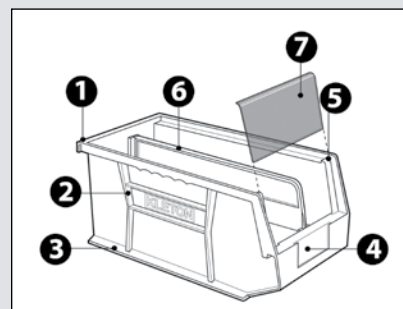
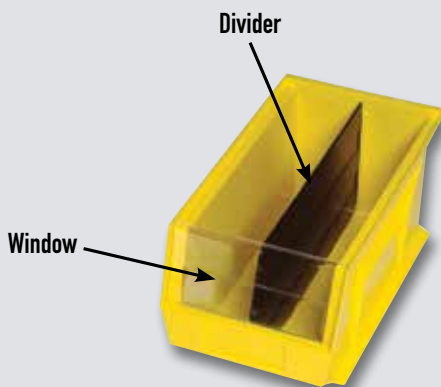

1. Full width hanger supports bins when suspended from louvered panels or rails
2. Reinforced rib design adds strength and prevents spreading when stacked
3. Extra-wide ledges for secure stacking and stability
4. Large front label slots ideal for larger bar code scanning and content identification
5. Anti-slide stop prevents stacked bins from shifting forward
6. Optional dividers increase storage options
7. Optional windows maximize storage capacity, prevent spillage and protect parts from dust and dirt

| Bin Model No. | | | | | Outside Dimensions W" x D" x H" | Inside Dimensions W" x D" x H" | Inside Bottom Depth X" | Bin Load Cap. lbs. | Uses Divider | Uses Clear Window |
|---------------|-------|--------|-------|-------|------------------------------------|-----------------------------------|---------------------------|-----------------------|-----------------|-------------------------|
| Blue | Red | Yellow | Green | Black | | | | | | |
| CF820 | CF822 | CF823 | CF821 | CF824 | 4-1/8 x 5-3/8 x 3 | 3-7/16 x 4-3/4 x 2-13/16 | 4 | 10 | CB825 | - |
| CF825 | CF827 | CF828 | CF826 | CF829 | 4-1/8 x 7-3/8 x 3 | 3-7/16 x 6-3/4 x 2-13/16 | 6 | 10 | CB826 | - |
| CF830 | CF832 | CF833 | CF831 | CF834 | 5-1/2 x 10-7/8 x 5 | 4-3/8 x 10-1/4 x 4-3/4 | 9 | 30 | CB829 | CB814 |
| CF835 | CF837 | CF838 | CF836 | CF839 | 11 x 10-7/8 x 5 | 10 x 10-1/4 x 4-3/4 | 9 | 50 | CB829 | CB815 |
| CF840 | CF842 | CF843 | CF841 | CF844 | 8-1/4 x 10-3/4 x 7 | 6-9/16 x 10 x 6-3/4 | 8 | 50 | CB830 | CB818 |
| CF845 | CF847 | CF848 | CF846 | CF849 | 8-1/4 x 14-3/4 x 7 | 6-9/16 x 14 x 6-3/4 | 12 | 60 | CB831 | CB818 |
| CF850 | CF852 | CF853 | CF851 | CF854 | 16-1/2 x 14-3/4 x 7 | 14-3/4 x 14 x 6-3/4 | 12 | 75 | CB831 | CB819 |

JUMBO PLASTIC CONTAINERS

- Extra-large size provides massive amount of storage capacity
- Guaranteed unbreakable and distortion-free from -40°C to 120°C
- Unaffected by oil, alkaline, and most acids
- Nesting design allows for minimal storage space when not in use
- Stackable for added space savings, up to four high
- Outside Dimensions: 15-1/2" W x 25" D x 13" H
- Inside Dimensions: 13-1/2" W x 22-3/5" D x 12" H
- Capacity: 200 lbs.



| Model No. | Colour |
|-----------|--------|
| CF328 | Blue |
| CF330 | Yellow |
| CF329 | Green |
| CF327 | Red |

HEAVY-DUTY TILT BINS

- Extremely durable ABS plastic housing and drawer body
- Transparent polystyrene front window for easy viewing
- Conveniently connects to each other with grooved channels on top, bottom and sides
- Shake resistant design prevents drawers from opening on their own
- Keyholes on back for wall mounting applications
- Colour: Black and grey



| Model No. | No. of Drawers | Bin Dimensions W" x D" x H" | Cabinet Dimensions W" x D" x H" | Wt. lbs. |
|-----------|----------------|-----------------------------|---------------------------------|----------|
| CF471 | 8 | 2-3/4 x 3-1/4 x 3-5/8 | 11-3/4 x 2-3/4 x 7-7/8 | 1.8 |
| CF472 | 6 | 3-11/16 x 4 x 4-5/8 | 11-3/4 x 3-1/2 x 9-3/4 | 2.26 |
| CF473 | 5 | 4-1/2 x 4-7/8 x 5-1/2 | 23-1/2 x 4 x 5-7/8 | 2.84 |
| CF474 | 4 | 5-5/8 x 6-3/8 x 7-1/2 | 23-1/2 x 5-1/2 x 7-7/8 | 3.10 |

MOBILE TILT BIN RACKS

- Heavy duty steel frame
- Durable powder coat paint finish on galvanized steel
- 3" swivel casters with brake
- Takes up to six mounting channels per side
- 46 Bins
- Unit Type: Single-sided
- Overall dimensions: 26 1/4" W 22" D x 57 1/2" H

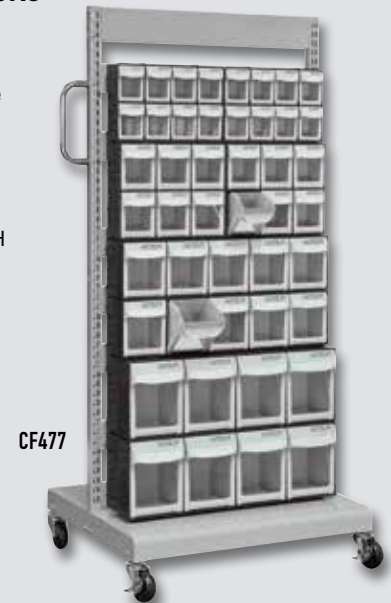

| Model No. | Description | Bin Units Included |
|-----------|---|--------------------------------------|
| CF477 | Single Sided | 2 of each CF471, CF472, CF473, CF474 |
| CF478 | Double Sided | 4 of each CF471, CF472, CF473, CF474 |
| CF475* | Cart Only | - |
| CF476 | Mounting Channel for Heavy-Duty Tilt Bins | |
| CF502 | Mounting Channel for Plastic Bins | |

* Mounting channels and bins not included

MOUNTING CHANNEL FOR MOBILE TILT BIN RACK

- Takes up to six mounting channels per side
- CF473 tilt bins take up to eight mounting channels per side
- CF471 and CF472 take 2 bin units per level per side

Model No. **CF476**



SEE PLASTIC BINS FOR CF502 MOUNTING CHANNEL on Page 28



DRAWER CABINET TRUCKS

- Allows repair or assembly parts to be transported directly to the work site
- Lower shelf provides added storage capacity
- Rolls smoothly on two rigid and two swivel 5" rubber casters
- Drawers come with two adjustable dividers and full width handles
- Overall truck dimensions: 36" W x 18" D x 35" H



| Model No. | No. of Drawers | Bin Dimensions W" x D" x H" | Wt. lbs. |
|-----------|----------------|-----------------------------|----------|
| MA245 | 18 | 5-3/8 x 17 x 3-1/2 | 134 |
| MA246 | 24 | 5-3/8 x 17 x 2 | 145 |
| MA247 | 36 | 5-3/8 x 17 x 3-1/2 | 195 |
| MA248 | 48 | 5-3/8 x 17 x 2 | 220 |

COLLAPSIBLE CONTAINERS

COLLAPSIBLE CONTAINER

- Polypropylene construction
- Reinforced base for added durability
- 16 heavy-duty steel pins built in for increased strength
- Collapses to 21" L x 14" W x 2" H for convenient storage
- Open dimensions: 21" L x 14" W x 10-1/2" H
- Capacity: 160 lbs.

Model No. **CF326**



COLLAPSED



CF326

FLIP TOP PLASTIC DISTRIBUTION CONTAINER

- Reusable containers are ideal for use in wholesale product distribution and as picking containers
- Hinged lids with tight interlocking fit provide added security and protection
- When lids are closed, containers can be easily stacked
- Nests with lids open for optimal use of space
- Height: 12.5"
- Width: 21.65"
- Depth: 15.5"
- Volume Cu. Ft.: 1.8

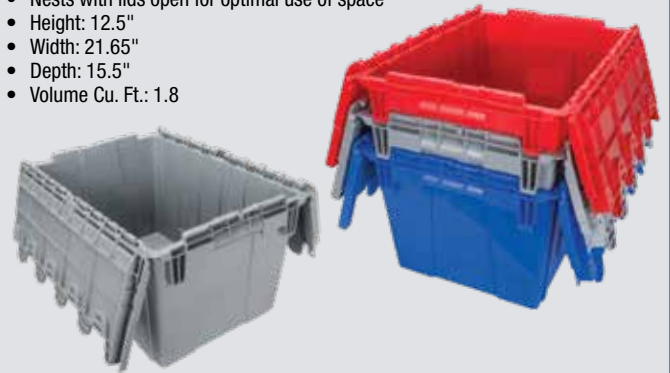

| Model No. | Colour |
|--------------|--------|
| CG125 | Grey |
| CG126 | Red |
| CG127 | Blue |

COLLAPSIBLE BULK CONTAINER

- Drop gates knock-down with ease
- Quickly collapsed, folded, and stacked for convenient transportation
- Max. Height: 39.4"
- Max. Length: 47.2"
- Max. Width: 39.4"
- No. of Drop Gates: 2
- Capacity: 2000 lbs.
- Colour: Grey

Model No. **CF862**
Price/Each: **00.00**

Lid for Collapsible Bulk Container
Model No. **CF863**



COLLAPSIBLE WIRE CONTAINER

- Welded, mesh wire maximizes visibility and ventilation
- Can be stacked up to 4 high
- Features a drop gate for easy access to products
- Equipped with 4 caster plates that are compatible with all KLETON casters
- Capacity: 4000 lbs.
- Overall Depth: 48"
- Overall Height: 42"
- Overall Width: 40"
- No. of Drop Gates: 1
- Collapsed height: 9"

Model No. **CG021**





Customize KLETON products to your specs!
See Inside Front Cover

STORAGE BINS & RACKS

HANGING METAL BIN PANELS

- Wall mount, attached to the back of shelving, mount on benches, carts, inside cabinets, fasten to slotted angle components, or use for service truck interior
- Bins are easily removed, refilled and replaced
- Each heavy-duty panel is 16-gauge cold-rolled steel
- Slotted holes 3/4" L x 3/8" W at 6" centres simplify installation
- KLETON grey powder coated
- Installation note: Panels must be securely fastened to materials of adequate load bearing strength
- Each panel must be secured vertically at the centre

CF412
(Bins not included)



METAL BIN PANELS

| Model No. | Panel Size W" x H" | Wt. lbs. |
|-----------|--------------------|----------|
| CF411 | 18 x 19 | 6 |
| CF412 | 36 x 19 | 12 |

BIN QUANTITY TABLE - QUANTITY OF IDENTICAL PLASTIC BINS THAT FIT MODEL CF412 PANEL

| Outside Bin Dimensions W" x D" x H" | Qty of Bins | Qty of Bins | Qty of Bins | Qty of Bins |
|-------------------------------------|-------------|-------------|-------------|-------------|
| | 1 Panel | 2 Panel | 3 Panel | 4 Panel |
| 4-1/8 x 5-3/8 x 3 | 32 | 72 | 104 | 144 |
| 4-1/8 x 7-3/8 x 3 | 32 | 72 | 104 | 144 |
| 5-1/2 x 10-7/8 x 5 | 18 | 36 | 54 | 72 |
| 11 x 10-7/8 x 5 | 9 | 18 | 27 | 36 |
| 8-1/4 x 10-3/4 x 7 | 8 | 18 | 28 | 36 |
| 8-1/4 x 14-3/4 x 7 | 8 | 16 | 28 | 36 |
| 16-1/2 x 14-3/4 x 7 | 4 | 8 | 14 | 18 |

NOTE: IF MOUNTING MORE THAN 1 PANEL

2 Panels = 37"H, 3 Panels = 55" H, 4 Panels = 73" H

Width of 2 panels combined: 35-3/4"

36" LOUVERED BENCH RACKS

- All-welded louvered bench rack
- Free standing unit made of 1" square tube frame
- May be placed on any flat surface near a worksite without the need for bolts or fasteners
- Durable KLETON blue enamel finish

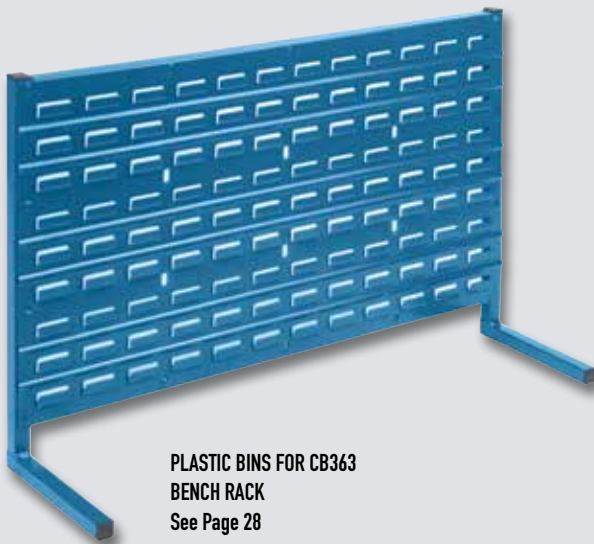

PLASTIC BINS FOR CB363 BENCH RACK
See Page 28

| Model No. | Description | Dimensions W" x D" x H" | Wt. lbs. |
|-----------|-------------------------------|-------------------------|----------|
| CB363 | Free Standing Bench Rack Only | 36 x 10 x 22 | 22 |

RACK WITH BIN COMBINATIONS



| With Red Bins | With Blue Bins | With Yellow Bins | With Green Bins | Outside Bin Dimensions W" x D" x H" | Bin Qty | Bin Cap lbs. |
|---------------|----------------|------------------|-----------------|-------------------------------------|---------|--------------|
| CB146 | CB145 | CB147 | CF359 | 4-1/8 x 5-3/8 x 3 | 32 | 320 |
| CB152 | CB151 | CB153 | CF361 | 4-1/8 x 7-3/8 x 3 | 32 | 320 |
| CB155 | CB154 | CB156 | CF363 | 5-1/2 x 10-7/8 x 5 | 18 | 540 |

STORAGE BINS & RACKS

72" LOUVERED BENCH RACKS

- Provides tool and parts storage for assembly or repair operations when combined with plastic parts bins
- All-welded louvered bench rack
- Designed to be permanently installed on a 72" wide workbench
- Constructed of 1-1/4" square tube frame
- Durable KLETON blue enamel finish

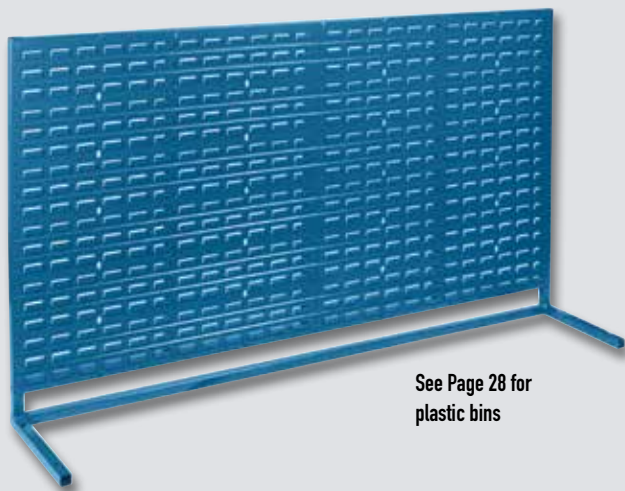

See Page 28 for plastic bins

| Model No. | Description | Dimensions W" x D" x H" | Wt. lbs. |
|-----------|--------------------|-------------------------|----------|
| CB364 | Bolt-on Bench Rack | 72 x 15 x 40 | 95 |

RACK WITH BIN COMBINATIONS



| With Red Bins | With Blue Bins | With Yellow Bins | With Green Bins | Outside Bin Dimensions W" x D" x H" | Bin Qty | Total Bin Cap lbs. |
|---------------|----------------|------------------|-----------------|-------------------------------------|---------|--------------------|
| CB173 | CB172 | CB174 | CF365 | 4-1/8 x 7-3/8 x 3 | 144 | 1440 |
| CB176 | CB175 | CB177 | CF367 | 5-1/2 x 10-7/8 x 5 | 72 | 2160 |
| CB185 | CB184 | CB186 | CF369 | 8-1/4 x 14-3/8 x 7 | 36 | 2160 |



STATIONARY RACKS WITH BIN COMBINATIONS

- Designed to be permanently installed to the floor
- All-welded stationary bin racks
- Constructed of 1 1/4" square tube frame
- Choose from either single or double-sided racks to meet your storage needs
- Durable KLETON blue enamel finish

| W/Red Bins | W/Blue Bins | W/Yellow Bins | W/Green Bins | Rack Type | Outside Bin Dimensions W" x D" x H" | Bin Qty | Total Bin Capacity lbs. |
|------------|-------------|---------------|--------------|--------------|-------------------------------------|---------|-------------------------|
| CB654 | CB655 | CB656 | CB685 | Single-Sided | 8-1/4 x 14-3/4 x 7 | 28 | 1680 |
| CB370 | CB371 | CB372 | CB687 | Double-Sided | 8-1/4 x 14-3/4 x 7 | 56 | 3360 |

ACCESSORIES FOR LOUVERED PANELS

| Model No. | Description |
|-----------|------------------|
| CC165 | Round Hook, 6" |
| CC166 | Round Hook, 12" |
| CC167 | Square Hook, 6" |
| CC168 | Square Hook, 12" |



Round Hook



Square Hook



Customize KLETON products to your specs!
See Inside Front Cover

STORAGE BINS & RACKS

MOBILE BIN CARTS

- All-welded bin cart
- Work surface made of 14-gauge steel
- Includes bolted-on 5" non-marking casters and two louvered panels
- Durable KLETON blue enamel finish

1000-LB. CAPACITY



BIN QUANTITY TABLE QUANTITY OF IDENTICAL PLASTIC BINS THAT FIT MODEL CB365

| Outside Bin Dimensions | | | | Qty of Bins |
|------------------------|---|--------|------|-------------|
| W" | x | D" | x H" | |
| 8-1/4 | x | 14-3/4 | x 7 | 16 |
| 16-1/2 | x | 14-3/4 | x 7 | 4 |



| Model No. | Description | Dimensions W" x D" x H" | Wt. lbs. |
|-----------|-------------|-------------------------|----------|
| CB365 | Cart Only | 24 x 38-1/2 x 36-1/2 | 95 |

CARTS/BIN COMBINATION

| W/Blue Bins | W/Red Bins | W/Yellow Bins | W/Green Bins | Bin /Qty |
|-------------|------------|---------------|--------------|----------|
| CB366 | CB367 | CB368 | CB689 | 20 |

MOBILE SINGLE SIDED BIN RACKS

- Ideal for transportation of small parts
- All-welded single-sided mobile bin rack
- Includes 3" casters and two louvered panels
- Durable KLETON blue enamel finish

800-LB. CAPACITY



BIN QUANTITY TABLE QUANTITY OF IDENTICAL PLASTIC BINS THAT FIT MODEL CB359

| Outside Bin Dimensions | | | | Qty of Bins |
|------------------------|---|--------|------|-------------|
| W" | x | D" | x H" | |
| 5-1/2 | x | 10-7/8 | x 5 | 36 |

800-LB. CAPACITY



| Model No. | Description | Dimensions W" x D" x H" | Wt. lbs. |
|-----------|-------------|-------------------------|----------|
| CB359 | Rack Only | 36 x 16 x 52 | 60 |

RACK WITH BIN COMBINATIONS

| W/Blue Bins | W/ Red Bins | W/Yellow Bins | W/Green Bins | Bin /Qty |
|-------------|-------------|---------------|--------------|----------|
| CB650 | CB651 | CB652 | CB681 | 36 |

MOBILE BIN RACKS

MOBILE DOUBLE SIDED BIN RACKS

- Ideal for transportation of small parts
- All-welded double-sided mobile bin rack
- Includes bolted-on 5" non-marking casters and six louvered panels
- Durable KLETON blue enamel finish



**1000-LB.
CAPACITY**

| Model No. | Description | Dimensions W" x D" x H" | Wt. lbs. |
|-----------|-------------|-------------------------|----------|
| CB649 | Rack Only | 36 x 24 x 63 | 120 |

RACK WITH BIN COMBINATIONS

- Ideal for transportation of small parts
- All-welded double-sided mobile bin rack
- Includes bolted-on 5" non-marking casters and six louvered panels
- Durable KLETON blue enamel finish



**1000-LB.
CAPACITY**

| W/Blue Bins | W/Red Bins | W/Yellow Bins | W/Green Bins | Bin /Qty |
|-------------|------------|---------------|--------------|----------|
| CB089 | CB090 | CB091 | CB683 | 96 |

BIN/PEGBOARD COMBO RACK

- Mobile rack designed with (1) side pegboard & (1) side louvered panels (2 continuous)
- All-welded construction
- Square tube frame with angle iron base
- Equipped with (4) 5" non-marking, blue rubber casters (2 swivel, 2 rigid)
- Durable KLETON Blue enamel finish
- Bins not included
- Width: 38"
- Depth: 24-1/2"
- Height: 55"
- Capacity: 1000 lbs.
- Unit Type: Double-sided

Model No. **RN555**





Customize KLETON products to your specs!
See Inside Front Cover

BULK STACKING CONTAINERS

BULK STACKING CONTAINERS

- Heavy-duty all-welded construction
- Mesh containers use 2" x 2" x 10-gauge wire mesh
- All containers use a 13-gauge corrugated sheet steel base
- 2" x 2" x 3/16" angle posts
- 4-way fork truck entry with 4" under-clearance
- Available with one drop gate or fully enclosed sides
- Height: 24" inside, 30" overall
- Stackable up to 5 high
- Other sizes are available
- Painted durable KLETON blue

**3000-LB.
CAPACITY**

MESH CONTAINERS

| Model No. | Description | Capacity lbs. | Width" | Depth" | Wt. lbs. |
|-----------|----------------|---------------|--------|--------|----------|
| CF449 | Fully Enclosed | 3000 | 34-1/2 | 40-1/2 | 125 |
| CF450 | One Drop Gate | 3000 | 34-1/2 | 40-1/2 | 130 |
| CF451 | Fully Enclosed | 3000 | 40-1/2 | 48-1/2 | 150 |
| CF452 | One Drop Gate | 3000 | 40-1/2 | 48-1/2 | 160 |

CF449



**3500-LB.
CAPACITY**

SHEET CONTAINERS

| Model No. | Description | Capacity lbs. | Width" | Depth" | Wt. lbs. |
|-----------|----------------|---------------|--------|--------|----------|
| CF453 | Fully Enclosed | 3500 | 34-1/2 | 40-1/2 | 150 |
| CF454 | One Drop Gate | 3500 | 34-1/2 | 40-1/2 | 150 |
| CF455 | Fully Enclosed | 3500 | 40-1/2 | 48-1/2 | 185 |
| CF456 | One Drop Gate | 3500 | 40-1/2 | 48-1/2 | 185 |

CF453



**4500-LB.
CAPACITY**

CORRUGATED CONTAINERS

| Model No. | Description | Capacity lbs. | Width" | Depth" | Wt. lbs. |
|-----------|----------------|---------------|--------|--------|----------|
| CF457 | Fully Enclosed | 4500 | 34-1/2 | 40-1/2 | 160 |
| CF458 | One Drop Gate | 4500 | 34-1/2 | 40-1/2 | 160 |
| CF459 | Fully Enclosed | 4500 | 40-1/2 | 48-1/2 | 195 |
| CF460 | One Drop Gate | 4500 | 40-1/2 | 48-1/2 | 195 |

CF457



DOLLY FOR STACKING CONTAINER

Designed for use with any KLETON Bulk Stacking Containers

- Instantly make any stacking container mobile
- Retention posts for cup feet securely holds container in place
- Equipped with four 6" polyurethane swivel casters – 2 with brake
- Constructed from rugged 2" x 2" x 3/16" angle iron steel
- Dimensions: 48.5"W x 40.5"D x 10"H
- Capacity: 3000 lbs.
- Weight: 86 lbs.

Model No. **MP096**

MP096



STACKING RACKS

- Utilize warehouse airspace and lower the chances of damage that is associated with bulk stacking
- Designed for storage of loose and palletized goods
- Rugged all-welded 2" sq. tubing steel construction
- Holds 4000 lbs per rack and can be stacked four high
- Posts and bases are sold separately
- All-welded steel construction, ready to use
- Customizable to your specs
- Durable KLETON blue enamel finish

**4000-LB.
CAPACITY**

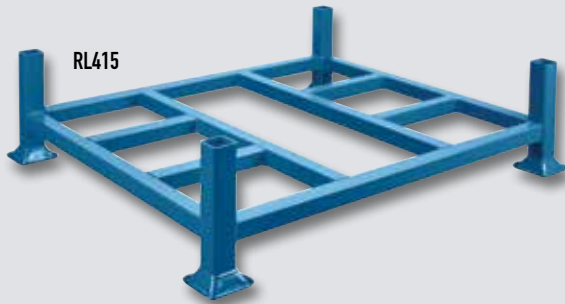

RL415

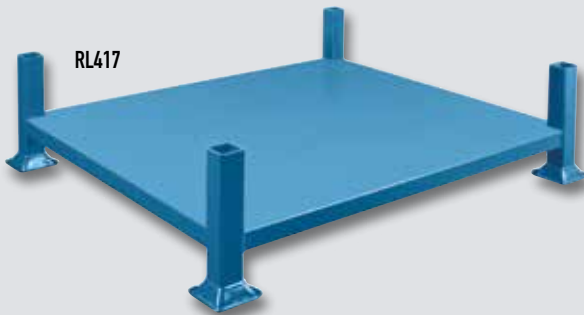

RL417



RL414 with 2 RL419

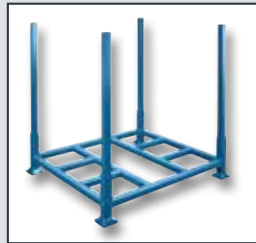

RL414 with 4 RL421

OPEN BASE FRAME

| Model No. | Inside Dimensions | Overall Dimensions | Wt. lbs. |
|-----------|-------------------|--------------------|----------|
| | D" x W" | D" x W" | |
| RL414 | 38 x 44 | 42 x 48 | 85 |
| RL415 | 44 x 44 | 48 x 48 | 90 |

CLOSED BASE FRAME

| | | | |
|-------|---------|---------|-----|
| RL416 | 38 x 44 | 42 x 48 | 110 |
| RL417 | 44 x 44 | 48 x 48 | 115 |

ACCESSORIES

| Model No. | Description | Overall Dimensions | Wt. lbs. |
|-----------|----------------------------|--------------------|----------|
| | | W" x H" | |
| RL418 | 42" Side Rail | 42 x 48 | 30 |
| RL419 | 48" Side Rail | 48 x 48 | 32 |
| RL420 | 42" Upright Post-Pack of 4 | 2 x 42 | 35 |
| RL421 | 48" Upright Post-Pack of 4 | 2 x 48 | 40 |
| RL422 | 60" Upright Post-Pack of 4 | 2 x 60 | 50 |

CABLE REEL ROLLERS

- For winding or dispensing cable, chain, wire, rope and hose
- Turns reel handling into a one-person operation
- Accommodates unlimited reel widths and all reel diameters with flanges up to 5-1/2" thick
- Rear roller adjusts to 6 positions
- Heavy-duty side rollers eliminate slipping or wedging between rollers and reel
- Inclined ramp permits for easy loading and unloading
- Durable KLETON blue enamel finish

**3000-LB.
CAPACITY
PER PAIR**



| Model No. | Overall Dimensions | Inclined Ramp Angle | Pair Wt. lbs. |
|-----------|--------------------|---------------------|---------------|
| | L" x W" x H" | | |
| MD166 | 28 x 9 x 4-1/4 | 68° | 58 |

REPLACEMENT WHEEL

| Model No. | Description |
|-----------|---------------------|
| MC064 | 3" Polyolefin Wheel |



Customize KLETON
products to your specs!
See Inside Front Cover

STORAGE RACKS

HORIZONTAL BAR STORAGE RACKS

- Ideal for storing bars, tube, pipe and angle
- Horizontally stores bars up to 10' long
- 9" deep arms with nine storage levels at 6" intervals
- Capacity: 1800 lbs.
- Durable KLETON blue enamel finish
- All-welded steel construction
- Shipped knocked down

**1800-LBS
CAPACITY**

| Model No. | Overall Dimensions W" x D" x H" | Wt. lbs. |
|-----------|------------------------------------|-------------|
| RB958 | 18 x 40 x 84 | 68 |

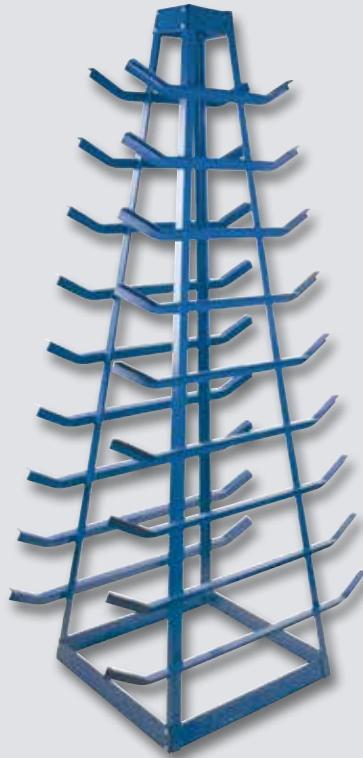

VERTICAL BAR STORAGE RACKS

- Ideal for storing bars, tube, pipe and angle
- All-welded steel construction
- Vertically stores bars up to 10' long
- Four 24" deep dividers
- Capacity: 3000 lbs.
- Durable KLETON blue enamel finish

**3000-LB.
CAPACITY**



| Model No. | Overall Dimensions W" x D" x H" | Wt. lbs. |
|-----------|------------------------------------|-------------|
| RL383 | 48 x 24 x 60 | 100 |

COMBINATION VERTICAL RACKS

- Stores bars up to 12' long and features three shelves for extra storage of small parts
- 8" deep arms divided into three sections
- Durable KLETON blue enamel finish
- Shipped knocked down

**3000-LB.
CAPACITY**



| Model No. | Overall Dimensions W" x D" x H" | Wt. lbs. |
|-----------|------------------------------------|-------------|
| RL922 | 36 x 24 x 84 | 128 |

STANDARD VERTICAL SHEET RACKS

- All-welded steel construction
- Designed for vertically storing sheet goods
- 4 bays with 10" between each bay
- Constructed of heavy gauge steel 1-1/4" tube for bays and a heavy gauge steel 1" x 2" rectangular tube for the frame
- Each bay can hold up to 1000 lbs.
- Capacity: 4000 lbs.
- Durable KLETON blue enamel finish

**4000-LB.
CAPACITY**

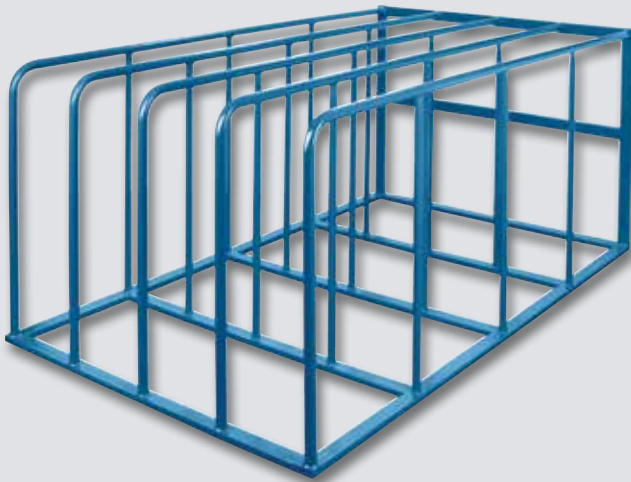

| Model No. | Overall Dimensions L" x W" x H" | Wt. lbs. |
|-----------|------------------------------------|-------------|
| RL384 | 50 x 84 x 36-3/4 | 200 |

HORIZONTAL SHEET RACKS

- Designed for storage of sheet materials
- Flat storage fully supports materials and reduces warping
- Sheets are accessible from all four sides
- All-welded construction and the frame is made of 2" square tubing
- Five shelf design creates four storage bays spaced 9-1/2" apart and a open top bay
- Bay Capacity: 2000 lbs. evenly distributed
- Maximum rack capacity: 8000 lbs.

**8000 - LB.
CAPACITY**
Evenly Distributed

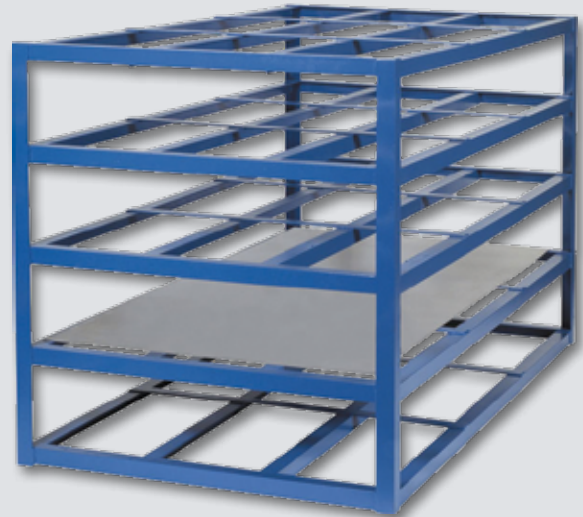

| Model No. | Overall Dimensions L" x W" x H" | Wt. lbs. |
|-----------|------------------------------------|-------------|
| RL923 | 103 x 55 x 48 | 575 |



**600-LB.
CAPACITY**

Convert rack to a
mobile unit using option
caster set MN425

CARTON RACKS

- All-welded steel construction, ready to use
- Single tier rack has 20" high dividers with 10-1/2" space between the dividers
- Double tier rack has 20" high dividers on the bottom with 10-1/2" space between the dividers and 14" high dividers on the top with 8-1/2" space between the dividers
- Capacity: 600 lbs.
- Durable KLETON blue enamel finish

| Model No. | Overall Dimensions W" x D" x H" |
|-------------------------|------------------------------------|
| SINGLE TIER RACK | |
| MN423 | 48 x 18 x 22 |
| DOUBLE TIER RACK | |
| MN424 | 48 x 18 x 58-1/2 |



Customize KLETON
products to your specs!
See Inside Front Cover

GAS CYLINDER CABINETS

GAS CYLINDER CABINETS

- Heavy-duty construction
- Innovative door design allows for left or right opening installation
- 2" x 2" 10-gauge formed steel angle posts
- 9-gauge wire mesh doors and walls for venting
- 14-gauge checker plate shelves and roof
- English and French warning labels included
- Padlock hasp for added security
- Safety yellow powder coat finish
- Shipped knocked down (except **SEB837** and **SEB838**)

COMPRESSED GAS (9" GAS CYLINDER BOTTLES)

| Model No. | Dimensions W" x D" x H" | Cylinder Capacity | Wt. lbs. |
|----------------|-------------------------|-------------------|----------|
| SAF837 | 44 x 30 x 74 | 10 | 210 |
| SAF848* | 88 x 30 x 74 | 20 | 420 |

* Consists of two units of **SAF837**

| Model No. | Dimensions W" x D" x H" | Cylinder Capacity | Wt. lbs. |
|----------------|-------------------------|-------------------|----------|
| SEB837* | 30 x 17 x 37 | 2 | 70 |
| SEB838* | 17 x 17 x 69 | 2 | 85 |
| SAF836 | 44 x 30 x 37 | 6 | 135 |
| SAF847 | 44 x 30 x 74 | 12 | 270 |

Notes: Constructed to meet or exceed strict CSA international B149.2-00 Propane Storage and Handling Code. Cylinders must be stored vertically at all times.

*Fully assembled all-welded construction



SAF837



SAF848



SEB837

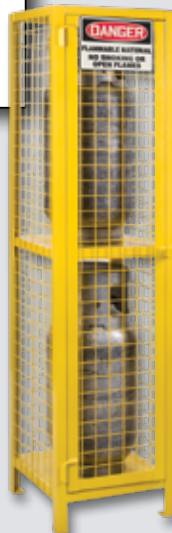

SEB838



SAF836



SAF847

WIRE MESH PARTITIONS & ENCLOSURES

WIRE MESH PARTITION COMPONENTS

Everything necessary to create your own custom enclosure.
Fast and easy assembly, multiple sizes available.
Please follow these guidelines for determining the components required.

1. UNIVERSAL POSTS

A post must be placed at each end of every panel (or of every stack of panels). Be sure to calculate an extra 2" of overall wall length for each post added. When a post meets an existing wall, add one **KD115** wall bracket for proper support (fasteners are included with **KD115** to mount to post, not to wall).

UNIVERSAL POSTS

| Blue Model No. | Yellow Model No. | Height | Wt. lbs. |
|----------------|------------------|--------|----------|
| KD053 | KH860 | 8' 3" | 22 |
| KD046 | KH922 | 10' 3" | 27 |
| KD050 | KH923 | 12' 3" | 28.5 |



2. PANELS

Whenever possible, stacking panels horizontally (one above the other) is more economical than placing them vertically (next to each other) - this is because fewer posts are required for wall support when panels are stacked.

Examples:

- For an 8' high partition, stack two **KD037** (8' x 4') panels horizontally
- For a 10' high partition, stack two **KD037** (8' x 4') and one **KD033** (8' x 2') panel horizontally
- For a 12' high partition, stack three **KD037** (8' x 4') panels horizontally

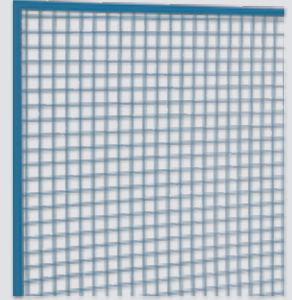

PANELS

| Blue Model No. | Yellow Model No. | Black Model No. | Frame Dim. W' x H' | Wt. lbs |
|----------------|------------------|-----------------|--------------------|---------|
| KD121 | KH926 | RN615 | 4 x 1 | 10 |
| KD120 | KH927 | RN616 | 8 x 1 | 21 |
| KD030 | KH928 | RN617 | 2 x 2 | 10 |
| KD031 | KH929 | RN618 | 3 x 2 | 15 |
| KD032 | KH914 | KI278 | 4 x 2 | 12 |
| KD033 | KH915 | KI279 | 8 x 2 | 28 |
| KD034 | KH916 | KI280 | 8 x 3 | 33 |
| KD035 | KH930 | RN619 | 3 x 4 | 20 |
| KD036 | KD130 | KI281 | 4 x 4 | 23 |
| KD037 | KD131 | KI282 | 8 x 4 | 42 |



3. ADJUSTABLE FILLER PANELS

Adjustable filler panels fill in blank spots on the ends of wire mesh partitions to plug up potential security risks. Filler panels come in two sizes: 1' x 4' and 1' x 8' that slide over the ends of existing wire mesh sections. Bolt holes on the filler panels are separated per every inch and allow the filler panel to fill in a space between 6" and 10" wide. The holes line up with holes on the existing panel which are drilled in at the top and bottom to securely fasten the filler panel in two places.

Adjustable
Filler Panels



| Blue Model No. | Yellow Model No. | Black Model No. | Dimensions W' x H' | Wt. lbs. |
|----------------|------------------|-----------------|--------------------|----------|
| KD119 | KH924 | RN620 | 4 x 1 | 10 |
| KD118 | KH925 | RN621 | 8 x 1 | 16 |



Customize KLETON products to your specs!
See Inside Front Cover

WIRE MESH PARTITIONS & ENCLOSURES

WIRE MESH PARTITION COMPONENTS CONT'D

4. SWING DOORS

Heavy-Duty

- Frame constructed with 1-1/4" x 1-1/4" square tube and 1" x 1" angle iron
- All are 7' in height and include a 1' transom for a total of 8' height
- May swing outwards to the left or to the right (except the **KD112** and **KH937** heavy swing door with wicket which swings open to the left only)
- Fasteners are included

Standard-Duty

- Frame constructed with 1-1/4" x 1-1/4" angle iron frame
- All are 7' in height and include a 1' transom for a total of 8' height
- May swing outwards to the left or to the right
- Fasteners are included

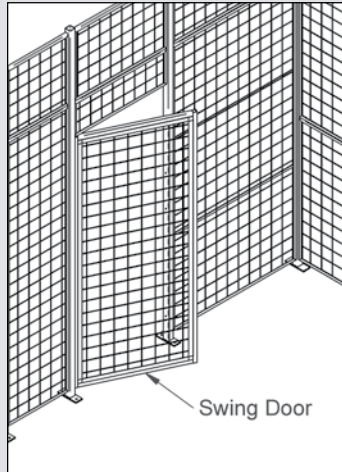

| Blue Model No. | Yellow Model No. | Black Model No. | Description | Dim. W' x H' |
|----------------|------------------|-----------------|--------------------|--------------|
| KD110 | KH933 | RN628 | Heavy-Duty Door | 3 x 7 |
| KH853 | KH934 | RN626 | Standard-Duty Door | 3 x 7 |
| KD111 | KH935 | RN629 | Heavy-Duty Door | 4 x 7 |
| KH854 | KH936 | RN627 | Standard-Duty Door | 4 x 7 |
| KD112 | KH937 | RN630 | Door c/w Wicket | 4 x 7 |

5. SLIDING DOORS

Heavy-Duty

- Frame constructed with 1-1/4" x 1-1/4" square tube and 1" x 1" angle iron
- All are 7' 7" in height and require one or more 8' lengths of 5" tall sliding door track, for a total of 8' height
- All sliding doors may slide open to the left or to the right
- To properly mount a sliding door, a post must be located on the side onto which the door slides, at the same distance away from the opening as the doors width

Standard-Duty

- Frame constructed with 1-1/2" x 1-1/2" angle iron frame
- All are 7' 7" in height and require one or more 8' lengths of 5" tall sliding door track, for a total of 8' height
- All sliding doors may slide open to the left or to the right
- To properly mount a sliding door, a post must be located on the side onto which the door slides, at the same distance away from the opening as the doors width

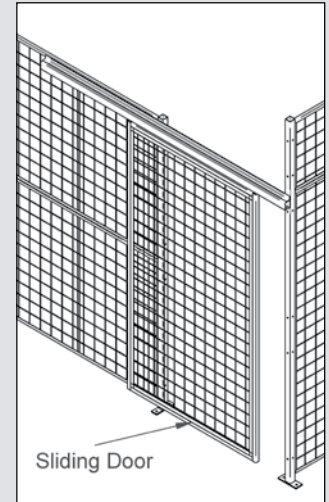

| Blue Model No. | Yellow Model No. | Black Model No. | Description | Dim. W' x H' |
|----------------|------------------|-----------------|--------------------|--------------|
| KH852 | KH938 | RN625 | Standard-Duty Door | 4 x 8 |
| KD106 | KH939 | RN622 | Heavy-Duty Door | 4 x 8 |
| KD108 | KH940 | RN624 | Heavy-Duty Door | 8 x 8 |
| KD107 | KH941 | RN623 | Heavy-Duty Door | 8 x 10 |

6. HARDWARE REQUIRED

For Each Stacked Panel Add:

- 4 x **MMH254**, 4 x **MMM966** for each 8' stacked panel
- 2 x **MMH254**, 2 x **MMM966** for each stacked panel under 8' long

For Each Post Add:

- 8 x **MMH262**, 8 x **MMM966**, 2 x **KD001** for each **KD053** and **KH860**
- 12 x **MMH262**, 12 x **MMM966**, 2 x **KD001** for each **KD046** and **KH922**
- 12 x **MMH262**, 12 x **MMM966**, 2 x **KD001** for each **KD050** and **KH923**

For Each Sliding Door Add:

- 1 x Sliding Door Hardware Kit, 1 x 8' Door Track for each 4' wide sliding door (see chart for colours)
- 1 x Sliding Door Hardware Kit, 2 x 8' Door Track for each 8' wide sliding door (see chart for colours)

| Blue Model No. | Yellow Model No. | Black Model No. | Description | Wt. lbs. |
|----------------|------------------|-----------------|---------------------------|----------|
| KD029 | KH942 | RN656 | 8' Door Track | 16 |
| KD028 | KH943 | RN655 | Sliding Door Hardware Kit | 6 |
| KD115 | KH944 | - | Wall Bracket Kit | 0.1 |
| MMH254* | - | - | 5/16" x 1" Carriage Bolt | 0.01 |
| MMH262* | - | - | 5/16" x 3" Carriage Bolt | 0.01 |
| MMM966 | - | - | Nut 5/16" Hex. | 0.01 |
| KD001 | - | - | 3/8" Anchor Bolt | 0.01 |

* 1 x **MMM966** is required for each **MMH254** and **MMH262**

CALL YOUR DISTRIBUTOR TODAY, FOR YOUR CUSTOM APPLICATION.



WIRE MESH PARTITION KITS

Customize KLETON
products to your specs!
See Inside Front Cover



Rugged KLETON wire mesh partitions and enclosures provide maximum security at low cost for tools, valuable inventory, hazardous materials, and any area of your plant where restricted access is required. Bolt-down posts and reinforced panels provide the strength that your application demands.

Standard STOCK SIZES include all basic bolt-together hardware required for fast and easy installation of modular wall and roof panels, and a standard 4' x 8' or 8' x 8' sliding door which may be located on any side, opening left-to-right or right-to-left. This system provides the versatility needed to expand or modify your enclosure quickly and at minimum cost. Order an enclosure with a roof for maximum security. CUSTOM SIZES can be designed to suit your special application regardless of the size required. Colour: KLETON blue.

TYPE A - 2 SIDES

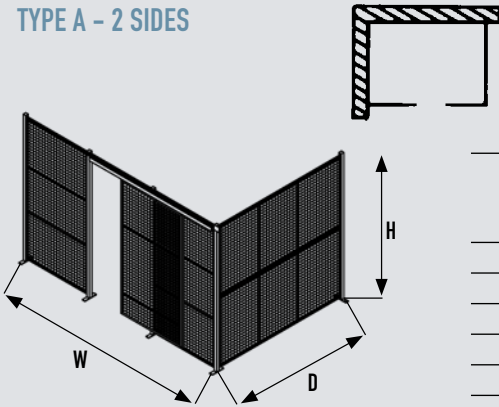

| Unit Height | Overall Wall Size W x D | Standard Sliding Door Size W x H | WITHOUT ROOF | | WITH ROOF | |
|-------------|----------------------------|-------------------------------------|--------------|----------|-----------|----------|
| | | | Model No. | Wt. lbs. | Model No. | Wt. lbs. |
| 8'3" | 12'8" x 8'4" | 4' x 8' | KD069 | 400 | KD070 | 660 |
| 8'3" | 16'8" x 12'6" | 4' x 8' | KD057 | 505 | KD058 | 1235 |
| 8'3" | 24'8" x 16'6" | 8' x 8' | KD061 | 650 | KD062 | 1960 |
| 12'3" | 12'8" x 8'4" | 4' x 8' | KD067 | 540 | KD068 | 805 |
| 12'3" | 16'8" x 12'6" | 4' x 8' | KD055 | 695 | KD056 | 1430 |
| 12'3" | 24'8" x 16'6" | 8' x 8' | KD059 | 900 | KD060 | 2215 |

TYPE B - 3 SIDES

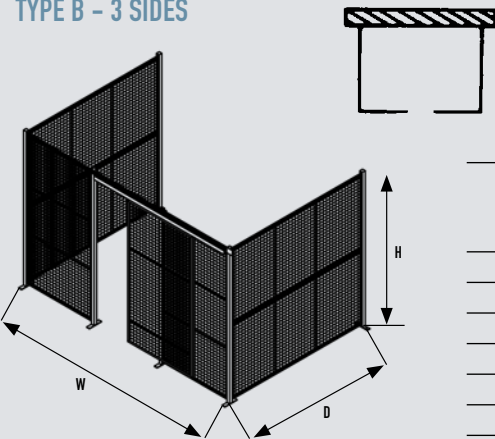

| Unit Height | Overall Wall Size W x D | Standard Sliding Door Size W x H | WITHOUT ROOF | | WITH ROOF | |
|-------------|----------------------------|-------------------------------------|--------------|----------|-----------|----------|
| | | | Model No. | Wt. lbs. | Model No. | Wt. lbs. |
| 8'3" | 12'8" x 8'4" | 4' x 8' | KD085 | 505 | KD086 | 745 |
| 8'3" | 16'8" x 12'6" | 4' x 8' | KD073 | 675 | KD074 | 1400 |
| 8'3" | 24'8" x 16'6" | 8' x 8' | KD077 | 860 | KD078 | 2175 |
| 12'3" | 12'8" x 8'4" | 4' x 8' | KD083 | 695 | KD084 | 1070 |
| 12'3" | 16'8" x 12'6" | 4' x 8' | KD071 | 945 | KD072 | 1670 |
| 12'3" | 24'8" x 16'6" | 8' x 8' | KD075 | 1210 | KD076 | 2525 |

TYPE C - 4 SIDES

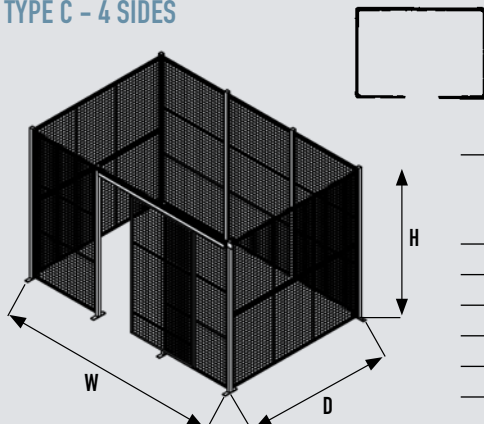

| Unit Height | Overall Wall Size W x D | Standard Sliding Door Size W x H | WITHOUT ROOF | | WITH ROOF | |
|-------------|----------------------------|-------------------------------------|--------------|----------|-----------|----------|
| | | | Model No. | Wt. lbs. | Model No. | Wt. lbs. |
| 8'3" | 12'8" x 8'4" | 4' x 8' | KD101 | 675 | KD102 | 945 |
| 8'3" | 16'8" x 12'6" | 4' x 8' | KD089 | 890 | KD090 | 1605 |
| 8'3" | 24'8" x 16'6" | 8' x 8' | KD093 | 1160 | KD094 | 2455 |
| 12'3" | 12'8" x 8'4" | 4' x 8' | KD099 | 950 | KD100 | 1220 |
| 12'3" | 16'8" x 12'6" | 4' x 8' | KD087 | 1260 | KD088 | 1975 |
| 12'3" | 24'8" x 16'6" | 8' x 8' | KD091 | 1650 | KD092 | 2945 |



Customize KLETON products to your specs!
See Inside Front Cover

SAFETY GUARDS

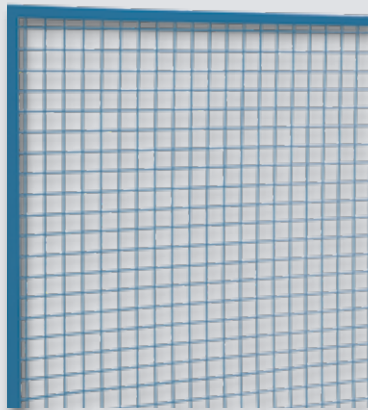

KD036

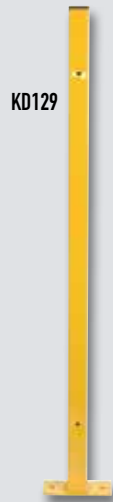

KD129

MESH STYLE INDIVIDUAL COMPONENTS

| Blue Model No. | Yellow Model No. | Description | Dimensions | Wt. lbs. |
|----------------|------------------|----------------|-------------|----------|
| KD036 | KD139 | Mesh Panel | 4' H x 4' W | 23 |
| KD037 | KD131 | Mesh Panel | 4' H x 8' W | 42 |
| KH861 | KD129 | Post Universal | 49-1/2" H | 13 |

HARDWARE REQUIRED

| Model No. | Description |
|-----------|---|
| KD001 | Floor Anchors (Two per Post) |
| MMH262 | 5/16" x 3" Carriage Bolt (Four per Frame) |
| MMM966 | 5/16" Hex Nut (One Nut for Each MMH262) |
| KD116 | Post Caps (One per Post) |

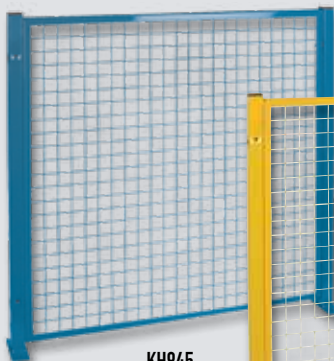

KH945

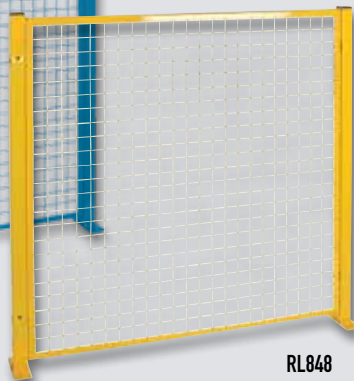

RL848

MESH STYLE KITS

- Create your own barrier guards with two styles to choose from: 2" x 2" welded wire mesh or 2" square tube
- Both feature a unique 49-1/2" overall height, and are easily installed
- Posts are constructed of 2" square tube with 5/16" base plate with holes for anchoring to floor
- Hardware to attach add-on sections is included
- Safety yellow or KLETON blue powder coat finish

| Blue Model No. | Yellow Model No. | Description | Dimensions W" x H" | Wt. lbs. |
|----------------|------------------|-----------------|--------------------|----------|
| KH945 | RL848 | Starter Section | 48 x 48 | 46 |
| KH946 | RL849 | Add-On Section | 48 x 48 | 34 |
| KH947 | RL850 | Starter Section | 96 x 48 | 65 |
| KH948 | RL851 | Add-On Section | 96 x 48 | 53 |

Note: Includes assembly fasteners, floor anchors and post caps

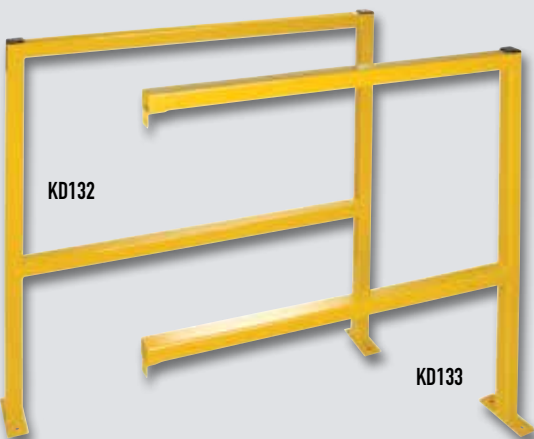

KD132

KD133

SQUARE TUBE STYLE KITS

| Model No. | Safety Guards | Dimensions W" x H" | Wt. lbs. |
|-----------|-----------------|--------------------|----------|
| KD132 | Starter Section | 48 x 49-1/2 | 45 |
| KD133 | Add-On Section* | 46 x 49-1/2 | 32 |
| KD134 | Starter Section | 96 x 49-1/2 | 66 |
| KD135 | Add-On Section* | 94 x 49-1/2 | 53 |

*Hardware to attach add-on section is included

HARDWARE REQUIRED

| | |
|-------|----------------------------|
| KD001 | Floor Anchors (2 Per Post) |
| KD116 | Post Caps (1 Per Post) |



STEEL RACKING AISLE PROTECTORS

- Prevent collision damage to shelving/racking from fork lifts, pallet trucks or other in-plant vehicle accidents
- Corner wraps are 12" high with an angle of 5" H x 3" W x 1/4" D with holes for anchoring to the floor
- Protectors can be customized to any other lengths and/or depths required
- Floor anchors not included
- Safety yellow powder coat finish
- All welded construction



RN059



RN063

| Model No. | Description | Fits Upright Width" | Overall Dimensions L" x W" x H" | Wt. lbs. |
|-----------|---------------------|---------------------|---------------------------------|----------|
| RN059 | Single Wrap - Left | 42 | 46-1/2 x 3 x 12 | 38 |
| RN060 | Single Wrap - Right | 42 | 46-1/2 x 3 x 12 | 38 |
| RN061 | Single Wrap - Left | 48 | 52-1/2 x 3 x 12 | 41 |
| RN062 | Single Wrap - Right | 48 | 52-1/2 x 3 x 12 | 41 |
| RN063 | Double Wrap | 42 | 50-1/4 x 3 x 12 | 46 |
| RN064 | Double Wrap | 48 | 56-1/4 x 3 x 12 | 49 |

FLOOR ANGLE GUARD RAILS

- Floor angle guide rail helps keep traffic away from racking and shelving, walls, storage areas, offices, and other work areas
- The sturdy 5" H x 3" W x 1/4" D angle iron comes with holes to anchor to the floor
- Protectors can be customized to any other lengths and/or depths required
- Floor anchors not included
- Safety yellow powder coat finish
- All welded construction



RN065

| Model No. | Dimensions L" x W" x H" | Wt. lbs. |
|-----------|-------------------------|----------|
| RN065 | 48 x 3 x 5 | 26 |
| RN066 | 60 x 3 x 5 | 33 |
| RN067 | 120 x 3 x 5 | 66 |

BOLLARDS

- Bollards can be used to protect work areas, racking and personnel both indoors and outdoors
- Black plastic caps are removable
- Includes pre-drilled mounting holes
- Powder coat paint finish
- Material Steel



K1293

K1294

K1295

| Model No. | Dimensions L" x W" x H" | Wt. lbs. |
|-----------|-------------------------|----------|
| K1293 | 4-1/2 x 4-1/2 x 36 | 22 |
| K1294 | 4-1/2 x 4-1/2 x 42 | 26 |
| K1295 | 4-1/2 x 4-1/2 x 48 | 29 |



Customize KLETON products to your specs!
See Inside Front Cover

BOLLARDS, PROTECTORS & SAFETY GUARDS

SAFETY GUARDS

- Protect your equipment and personnel from accidental damage and injury
- 4" x 4" square tube welded to an 8" x 8" x 1/2" base, complete with four 3/4" diameter holes for anchoring to floor
- Safety yellow powder coat finish

| Model No. | Dimensions L" x H" | Wt. lbs. |
|-----------|--------------------|----------|
| KD127 | 24 x 18 | 65 |
| KH855 | 36 x 18 | 75 |
| KD128 | 48 x 18 | 85 |
| KD136 | 24 x 42 | 95 |
| KD856 | 36 x 42 | 110 |
| KD139 | 48 x 42 | 115 |

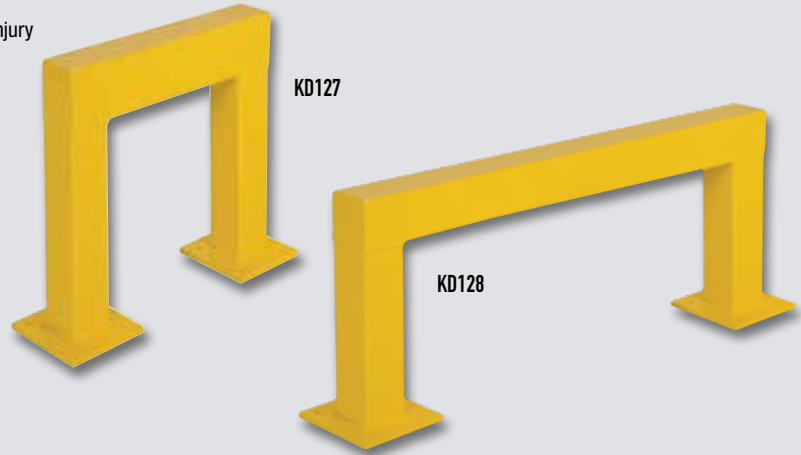

HEAVY-DUTY STEEL BOLLARDS

- Protect your warehouse equipment and high traffic areas
- 4" x 4" square tube welded to an 8" x 8" x 1/2" steel base complete with four 3/4" diameter holes for anchoring to floor
- Safety yellow powder coated finish

| Model No. | Height | Wt. lbs. |
|-----------|--------|----------|
| KD125 | 24 | 30 |
| KH857 | 36 | 40 |
| KD126 | 48 | 50 |

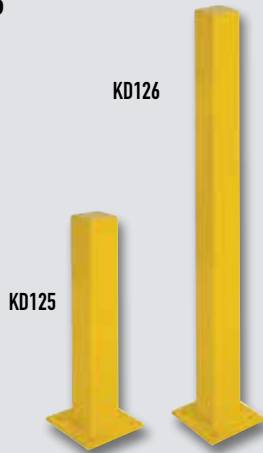

UPRIGHT PROTECTORS

- Protects industrial racking from damaging impacts that cause unsafe conditions
- Made from 1/4" thick steel
- Four pre-drilled holes made for 1/2" anchors (not included)
- Safety yellow powder coat finish

| Model No. | Overall Dimensions W" x D" x H" | Wt. lbs. |
|-----------|---------------------------------|----------|
| RB925 | 7 x 7 x 18-1/4 | 16 |
| KH858 | 7 x 7 x 12 | 11 |



PALLET RACK BACK GUARDS

Back guards help prevent accidents by keeping pallets or their contents from falling off the back. These guards increase safety where pedestrian pathways are behind the rack.

- Constructed using a 10-gauge frame, and 2" x 2" x 10-gauge wire mesh with stiffeners
- Available in a variety of sizes to fit most pallet rack configurations
- Guard brackets are designed to fit almost any style of rack
- Safety yellow powder coated finish

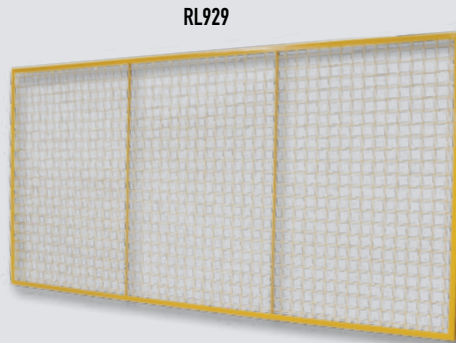

| Model No. | Description | Wt. lbs. |
|-----------|-------------------------------------|----------|
| RL929 | Back Guard 4' x 8' w/ 6" Brackets | 39 |
| RL930 | Back Guard 4' x 8' w/ 9" Brackets | 40 |
| RL931 | Back Guard 4' x 8' w/ 12" Brackets | 41 |
| RL932 | Back Guard 4' x 9' w/ 6" Brackets | 49 |
| RL933 | Back Guard 4' x 9' w/ 9" Brackets | 50 |
| RL934 | Back Guard 4' x 9' w/ 12" Brackets | 51 |
| RL935 | Back Guard 4' x 10' w/ 6" Brackets | 57 |
| RL936 | Back Guard 4' x 10' w/ 9" Brackets | 58 |
| RL937 | Back Guard 4' x 10' w/ 12" Brackets | 59 |
| RL938 | Back Guard 4' x 11' w/ 6" Brackets | 63 |
| RL939 | Back Guard 4' x 11' w/ 9" Brackets | 64 |
| RL940 | Back Guard 4' x 11' w/ 12" Brackets | 65 |
| RL941 | Back Guard 4' x 12' w/ 6" Brackets | 70 |
| RL942 | Back Guard 4' x 12' w/ 9" Brackets | 71 |
| RL943 | Back Guard 4' x 12' w/ 12" Brackets | 72 |

GUARD RAILS

MODULAR GUARD RAILS

- Modular design allows you to customize your guard rail system to meet your specific needs
- Durable powder coated safety yellow finish for better visibility
- When measuring a guardrail it is important to include the dimensions of the posts. Nominal length includes the width dimension of one post (5")



| Model No. | Dimensions L" x W" x H" | Nominal Length" |
|-----------|-------------------------|-----------------|
| KI237 | 19 x 3 x 12 | 24 |
| KI238 | 31 x 3 x 12 | 36 |
| KI239 | 43 x 3 x 12 | 48 |
| KI240 | 55 x 3 x 12 | 60 |
| KI241 | 67 x 3 x 12 | 72 |
| KI242 | 79 x 3 x 12 | 84 |
| KI243 | 91 x 3 x 12 | 96 |
| KI244 | 103 x 3 x 12 | 108 |
| KI245 | 115 x 3 x 12 | 120 |

SINGLE GUARD RAIL POST

- Modular design allows you to customize your guard rail system to meet your specific needs
- Durable powder coated safety yellow finish for better visibility
- Mounting hardware and plastic cap included, floor anchors and guard rails sold separately
- Dimensions: 5" L x 5" W x 17" H

Model No. **KI246**



DOUBLE GUARD RAIL POST

- Modular design allows you to customize your guard rail system to meet your specific needs
- Durable powder coated safety yellow finish for better visibility
- Mounting hardware and plastic cap included, floor anchors and guard rails sold separately
- Dimensions: 5" L x 5" W x 44" H

Model No. **KI247**



STRIP CURTAINS



EVERYTHING YOU NEED IN ONE PACKAGE TO INSTALL YOUR OWN STRIP CURTAIN DOOR AND SAVE MONEY!

ORDERING INFORMATION

Every strip curtain door comes complete with PVC strips and universal hardware for mounting strip curtain. Simple to follow installation instructions are included in every package.

1. Determine inside width and height of door opening.
NOTE: If mounting on door above lintel, measure from floor to mounting height.
2. Select type of PVC material required:
STANDARD or LOW TEMP.
Standard recommended for temperatures from -23°C to 66°C.
Low temp. recommended for interior use only for temperatures from -40°C to 66°C.
3. Select from the standard sizes listed in the chart below.
NOTE: If required size is not available, order the next largest size. Installation instructions describe how simple trimming can custom fit almost any door opening.
4. Special size doors and hanging applications are available upon request.
5. For overhead doors, please call one of our sales representatives for assistance.

EASY TO ORDER

It's easy to order the strip curtain that fits your door exactly because seven standard sizes can be made to fit 95% of most door openings. Special sizes are available.

IN-STOCK DELIVERY

We have the strip curtain package you need, in-stock, ready to be delivered to your door.

INTERIOR DOORS



Save energy costs

- The optimal solution to open door heat/cooling loss

Reduce noise pollution

- Provides the ideal accoustical barrier around noisy equipment

CONVEYORS

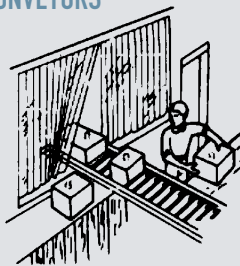

Provide extra safe passage

- People can see and be seen so there's less chance of accidents

Control smoke, dust and sprays

- Strip curtains can control in-plant contaminants to improve employee environment

Low maintenance

- Clear flexible vinyl resists stretching and stands up to abrasion
- All aluminum hardware is used for maximum durability
- May be quickly and easily cleaned with detergents or cleansing agents that are free from abrasives
- Deep stains and ingrained dirt etc. can be removed by carefully applying ethanol

DOCKS



STANDARD DOOR SIZES

| Strip Size | Door Opening W' x H' | Model No. | Model No. | Wt. lbs. |
|-----------------------|----------------------|-----------|-----------|----------|
| | | Standard | Low Temp. | |
| 8" (8" x 0.080") | 4 x 7 | KF022 | KF004 | 25 |
| | 5 x 8 | KF023 | KF005 | 35 |
| | 6 x 8 | KF024 | KF006 | 40 |
| 12" (12" x 0.120") | 8 x 8 | KF026 | KF008 | 80 |
| | 8 x 10 | KF025 | KF007 | 100 |
| | 10 x 10 | KF020 | KF002 | 125 |
| | 12 x 12 | KF021 | KF003 | 175 |

NOTE: Doors with 8" strips have 2" standard overlap. Doors with 12" strips have 4" standard overlap.

REPLACEMENT STRIPS - 5 PER CARTON

| Strip Size | Model No. Standard | Model No. Low Temp. | Wt. lbs. |
|--------------------|--------------------|---------------------|----------|
| 8" x 0.080" x 8' | KF032 | KF013 | 15 |
| 12" x 0.120" x 12' | KF029 | KF011 | 45 |

BULK ROLLS

| Strip Size | Roll' | Model No. Standard | Model No. Low Temp. | Wt. lbs. |
|--------------|-------|--------------------|---------------------|----------|
| 8" x 0.080" | 300 | KI226 | KI224 | 145 |
| 12" x 0.120" | 200 | KI225 | KI223 | 145 |

NOTE: Rolls also available in dark amber welding material ML959

| Model No. | Description |
|-----------|----------------------------------|
| KF001 | Complete 4' aluminum angle mount |

TARPAULINS

HEAVY DUTY CAMOUFLAGE TARPAULIN

- 10 x 10 weave density
- Water-resistant coating
- Reinforced polypropylene rope sewn in welded hems
- 150 micrometers (6 mil) thick
- Increased UV-resistance for long life
- Finished sizes may vary due to hem allowance



| Model No. | Dimensions L' x W' |
|-----------|--------------------|
| J1319 | 6 x 6 |
| J1320 | 10 x 8 |
| J1321 | 20 x 10 |
| J1322 | 16 x 12 |
| J1323 | 20 x 16 |
| J1324 | 24 x 18 |
| J1325 | 30 x 20 |
| J1326 | 40 x 30 |



INSULATED TARPAULIN

- Lightweight and flexible, moisture resistant insulated tarpaulin
- Manufactured with 3/16" closed cell polyethylene foam insulation
- R-value is maintained in damp cold conditions
- Durable, water resistant polyethylene shell
- Heavy-duty rust resistant grommets every 2'
- R value: 1.0
- Dimensions: 12' x 20'

Model No. **JD420**



LIGHT INDUSTRIAL POLYETHYLENE TARPAULIN

- 14 x 14 weave density
- Water-resistant coating
- Reinforced polypropylene rope sewn in welded hems
- 200 micrometers (8 mil) thick
- Increased UV-resistance for long life
- Finished sizes may vary due to hem allowance



| Model No. | Dimensions L' x W' |
|-----------|--------------------|
| J1327 | 8 x 6 |
| J1328 | 10 x 8 |
| J1329 | 20 x 10 |
| J1330 | 16 x 12 |
| J1331 | 20 x 16 |
| J1332 | 24 x 18 |
| J1333 | 30 x 20 |
| J1334 | 30 x 24 |
| J1335 | 40 x 30 |
| J1336 | 50 x 30 |
| J1337 | 50 x 40 |
| J1338 | 60 x 40 |

CLEAR TARPAULIN

- Polyethylene tarpaulin with reinforced nylon gridding
- Water and mildew resistant coating
- Heavy-duty rust resistant grommets every 27"
- 3 x 3 high density weave
- 200 micrometers (8 mils) thick



| Model No. | Dimensions L' x W' |
|-----------|--------------------|
| JD414 | 8 x 10 |
| JD415 | 10 x 12 |
| JD416 | 16 x 20 |
| JD417 | 20 x 30 |
| JD418 | 30 x 40 |
| JD419 | 40 x 60 |

* Finished sizes slightly smaller due to hem allowance

STANDARD-DUTY BLUE POLYETHYLENE

- 8 x 8 high density weave
- Reinforced polypropylene rope sewn in welded hems
- Heavy-duty rust-resistant grommets every 36"
- 100 micrometers (4 mils) thick
- Increased UV resistance for long life
- Water-resistant coating



| Model No. | Dimensions L' x W' |
|-----------|--------------------|
| NI768 | 5 x 7 |
| NI769 | 6 x 8 |
| NI770 | 8 x 10 |
| NI771 | 10 x 12 |
| NI772 | 10 x 20 |
| NI773 | 12 x 16 |
| NI774 | 16 x 20 |

| Model No. | Dimensions L' x W' |
|-----------|--------------------|
| NI775 | 18 x 24 |
| NI776 | 20 x 30 |
| NI777 | 24 x 30 |
| NI778 | 30 x 40 |
| JC510 | 30 x 50 |
| JC511 | 40 x 50 |
| NI779 | 40 x 60 |

HEAVY-DUTY WHITE POLYETHYLENE

- 10 x 10 high density weave
- Four corner rubber patches for added strength
- Reinforced polypropylene rope sewn in welded hems
- Heavy-duty rust-resistant grommets every 36"
- 150 micrometers (6 mils) thick
- Increased UV resistance for long life
- Water-resistant coating



| Model No. | Dimensions L' x W' |
|-----------|--------------------|
| NI780 | 6 x 8 |
| NI781 | 8 x 10 |
| NI782 | 10 x 12 |
| NI783 | 12 x 16 |
| NI784 | 16 x 20 |
| JC512 | 18 x 24 |

| Model No. | Dimensions L' x W' |
|-----------|--------------------|
| JC513 | 20 x 30 |
| NI785 | 24 x 30 |
| JC514 | 30 x 40 |
| JC515 | 30 x 50 |
| JC625 | 40 x 50 |
| JB508 | 40 x 60 |

INDUSTRIAL GREEN POLYETHYLENE

- 14 x 14 high density weave
- 225 micrometers (9-mil) thick
- 9" x 9" three layers on each four corners
- Reinforced polypropylene rope sewn in welded hems
- Heavy-duty rust-resistant grommets every 35"
- Increased UV resistance for long life
- Water-resistant coating

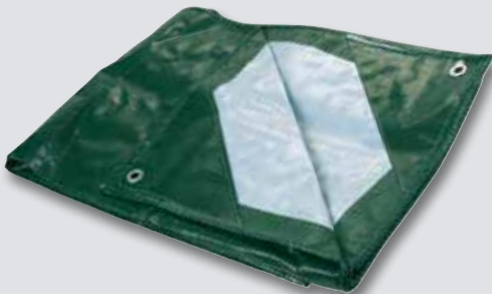

| Model No. | Dimensions L' x W' |
|-----------|--------------------|
| JB567 | 6 x 8 |
| JB568 | 8 x 10 |
| JB569 | 10 x 12 |
| JB570 | 12 x 16 |
| JB571 | 16 x 20 |

| Model No. | Dimensions L' x W' |
|-----------|--------------------|
| JB572 | 20 x 30 |
| JC516 | 30 x 40 |
| JC517 | 30 x 50 |
| JC518 | 40 x 50 |
| JB573 | 40 x 60 |

SUPER HEAVY-DUTY SILVER

- 16 x 16 high density weave
- Reinforced polypropylene rope sewn in welded hems
- Heavy-duty rust-resistant grommets every 30"
- 300 micrometers (12 mils) thick
- Increased UV resistance for long life
- Water-resistant coating
- 9" x 9" triple-layered on four corners



| Model No. | Dimensions L' x W' |
|-----------|--------------------|
| JC626 | 8 x 10 |
| JC627 | 10 x 12 |
| JC628 | 16 x 20 |
| JC629 | 18 x 24 |
| JC630 | 20 x 30 |

| Model No. | Dimensions L' x W' |
|-----------|--------------------|
| JC631 | 24 x 30 |
| JC632 | 30 x 40 |
| JC633 | 30 x 50 |
| JC634 | 30 x 60 |
| JC635 | 40 x 60 |

TARPAULINS, FURNITURE PADS & TIE DOWNS

RUBBER TIE DOWNS

- Material: EPDM gives the ability to resist degradation resulting from weathering agents like UV rays and ozone making it perfect weather resistant rubber
- Retains its rebound qualities
- Rubber Tie Downs Straps resist cracking and rotting
- Durable Zinc plated steel "S" hooks



| Model No. | Length" | Max. Safe Stretch" |
|-----------|---------|--------------------|
| PE366 | 5 | 7.5 |
| PE367 | 9 | 13.5 |
| PE368 | 15 | 22.5 |
| PE369 | 21 | 31.5 |
| PE370 | 31 | 46.5 |
| PE371 | 41 | 61.5 |

RUBBER TIE DOWN SETS

Same great features as KLETON rubber tie downs however in the convenience of sets!

10-PC. BASIC TIE DOWN SET

- Set Includes:**
- 4 - 21" tie downs (PE369)
 - 2 - 31" tie downs (PE370)
 - 4 - 41" tie downs (PE371)

Model No. **PF090**

16-PC. ALL-PURPOSE TIE DOWN SET

- Set Includes:**
- 2 - 9" tie downs (PE367)
 - 2 - 15" tie downs (PE368)
 - 4 - 21" tie downs (PE369)
 - 4 - 31" tie downs (PE370)
 - 4 - 41" tie downs (PE371)

Model No. **PF091**

20-PC. PROFESSIONAL TIE DOWN SET

- Set Includes:**
- 10 - 21" tie downs (PE369)
 - 10 - 41" tie downs (PE371)

Model No. **PF092**

ECONOMY FURNITURE PAD

- Protects furniture from scratches when moving
- Zig-zag stitching provides durability and consistent cushioning
- Dimensions: 80" x 72"
- Material: Cotton & Polyester
- Filling: 22 oz.

Model No. **PF797**



STANDARD FURNITURE PAD

- Protect furniture from scratches when moving
- Zig-zag stitching provides durability and consistent cushioning
- Weight: 29 oz.
- Size: 72" x 80"
- Colour: Camouflage
- Weight: 5 lbs.
- Material: Polypropylene

Model No. **PG302**



PREMIUM FURNITURE PADS

- Protect furniture from scratches when moving
- Zig-zag stitching provides durability and consistent cushioning
- Cotton and polyester material
- Filling: 40 oz.
- Size: 72" x 80"
- Weight: 5.5 lbs.
- Colour: Dark blue and light blue

Model No. **PF460**



STANDARD FURNITURE PADS

- Protect furniture from scratches when moving
- Zig-zag stitching provides durability and consistent cushioning
- Cotton and polypropylene material
- Filling: 29 oz.
- Size: 72" x 80"
- Weight: 5 lbs.
- Colour: Dark blue and green

Model No. **PF461**





LADDERS, STANDS & PLATFORMS

| | |
|---|---------|
| Work Platforms | 52 |
| Step Stands & Platforms | 52 |
| Tilt-N-Roll Step Stands | 52 |
| Step Stands | 53 |
| Rolling Ladders | 53 - 56 |
| Trailer Access Rolling Ladders | 54 |
| Tilt-N-Roll Ladders | 56 |
| Mechanics/Maintenance Rolling Ladders | 56 |
| Portable Folding Ladders | 56 |
| Maintenance Platforms | 57-58 |

STEP STANDS & PLATFORMS

Customize KLETON products to your specs!
See Inside Front Cover



WORK PLATFORMS

- Frame is welded 1" round steel tubing
- Elevate workers to comfortable working heights
- Provides solid footing around machinery and other work areas
- Non-clogging slip-resistant steel steps
- Durable KLETON blue enamel finish
- Meets ANSI standard A14.7

**800-LB.
CAPACITY**

| Model No. | Top Step W" x D" | Top Step Height" | Wt. lbs. |
|-----------|------------------|------------------|----------|
| VC127 | 24 x 32 | 6 | 28 |
| VC128 | 32 x 32 | 6 | 34 |
| VC129 | 24 x 32 | 12 | 32 |
| VC130 | 32 x 32 | 12 | 38 |



REPLACEMENT PARTS

Model No. **VC055**, Rubber Foot Tip

STEP STANDS

- Frame is welded 1" round steel tubing
- Rolling stand comes with 3" spring-loaded casters
- Non-clogging slip-resistant steel steps
- Durable KLETON blue enamel finish
- Meets ANSI standard A14.7

**300-LB.
CAPACITY**



STATIC STANDS

| Model No. | Overall Dim. W" x D" x H" | Top Step W" x D" | Wt. lbs. |
|-----------|---------------------------|------------------|----------|
| MH228 | 20 x 16 x 12 | 18 x 16 | 11 |
| MH229 | 24 x 16 x 12 | 22 x 16 | 13 |
| MH230 | 32 x 16 x 12 | 30 x 16 | 16 |

ROLLING STANDS

| Model No. | Overall Dim. W" x D" x H" | Top Step W" x D" | Wt. lbs. |
|-----------|---------------------------|------------------|----------|
| MH225 | 20 x 16 x 12 | 18 x 16 | 17 |
| MH226 | 24 x 16 x 12 | 22 x 16 | 19 |
| MH227 | 32 x 16 x 12 | 30 x 16 | 22 |

REPLACEMENT PARTS

Model No. **MA790**, Spring Loaded 3" Swivel Caster

Model No. **VC055**, Rubber Foot Tip

TILT-N-ROLL STEP STANDS

- Frame is welded 1" round steel tubing
- Handle allows step stand to move easily on two 4" casters
- Non-clogging slip-resistant steel steps
- Durable KLETON blue enamel finish
- Meets ANSI standard A14.7

**300-LB.
CAPACITY**



| Model No. | Number of Steps | Step Size W" x D" | Top Step Height" | Top Step W" x D" | Wt. lbs. | Base Dim. W" x D" |
|-----------|-----------------|-------------------|------------------|------------------|----------|-------------------|
| VC335 | 1 | 22 x 8 | 12 | 22 x 16 | 24 | 29 x 16 |
| VC336 | 2 | 22 x 8 | 19 | 22 x 16 | 33 | 29 x 24 |



Customize KLETON products to your specs!
See Inside Front Cover

ROLLING STEP LADDERS & STEP STOOL



MA613



MA612

24" WIDE ROLLING STEP LADDERS

- Frame is welded 1" round steel tubing
- For use in record storage rooms, offices, warehouses and confined spaces
- Rolls into position and locks firmly to the floor
- Casters retract under operator's weight while rubber feet drop down
- Non-clogging slip-resistant steel steps
- Durable KLETON blue enamel finish
- CSA certified to the ANSI standard A14.7

300-LB. CAPACITY

| Model No. | Number of Steps | Step Size W" x D" | Top Step Height" | Top Step W" x D" | Base Dim. W" x D" | Wt. lbs. |
|-----------|-----------------|-------------------|------------------|------------------|-------------------|----------|
| MA612 | 2 | 22 x 8 | 19 | 22 x 16 | 24 x 26 | 32 |
| MA613 | 3 | 22 x 8 | 28 | 22 x 16 | 24 x 30 | 42 |
| MH279 | 4 | 22 x 8 | 37 | 22 x 16 | 24 x 37 | 52 |
| MA615 | 5 | 22 x 8 | 46 | 22 x 16 | 24 x 41 | 61 |

REPLACEMENT PARTS

Model No. **MA790**, Spring Loaded 3" Swivel Caster

Model No. **VC055**, Rubber Foot Tip

20" WIDE ROLLING STEP LADDERS

- Frame is welded 1" round steel tubing
- Ideal wherever there is a need to reach materials
- Rolls easily into position and locks firmly to the floor for maximum safety
- Operate on spring-loaded casters
- Casters retract under operator's weight while rubber feet drop down
- Non-clogging slip-resistant steel steps
- Durable KLETON blue enamel finish
- Meets ANSI standard A14.7
- Step Size: 18" x 8"



300-LB. CAPACITY

| Model No. | Number of Steps | Top Step Height" | Top Step W" x D" | Base Dim. W" x D" | Wt. lbs. |
|-----------|-----------------|------------------|------------------|-------------------|----------|
| VC131 | 2 | 19 | 18 x 16 | 20 x 26 | 28 |
| VC132 | 3 | 28 | 18 x 16 | 20 x 30 | 38 |
| VC133 | 4 | 37 | 18 x 16 | 20 x 37 | 48 |
| VC134 | 5 | 46 | 18 x 16 | 20 x 41 | 57 |

REPLACEMENT PARTS

Model No. **MA790**, Spring Loaded 3" Swivel Caster

Model No. **VC055**, Rubber Foot Tip

HEAVY-DUTY STEEL STEP STOOL

- Comes with a double platform with non-slip rubber tread
- Spring-loaded casters retract under slight pressure, forcing base to the floor
- 11" diameter upper platform and 13-1/2" diameter lower platform
- 17-1/4" diameter base has an all-around protective bumper
- No. of Steps: 1
- Overall Dimensions: 16-1/2"H x 17-1/4" L x 17-1/4"W
- Colour: Black
- Weight: 12 lbs.

330-LB. CAPACITY

Model No. **ON528**



ROLLING STEP LADDERS

ROLLING STEP LADDER

- Ideal wherever there is a need to reach bulky materials
- Rolls easily into position and locks firmly to the floor for maximum safety
- Ladder operates on spring-loaded casters
- Casters retract under operator's weight, rubber feet drop down
- Non-clogging slip-resistant steel steps
- Frame is rugged welded 1" round steel tubing
- Durable KLETON blue enamel finish
- Constructed with handrails for extra support
- Frame Material: Steel
- Step Type: Perforated
- Certification(s): ANSI standard A14.7
- Step Size: 18" W x 8" D
- Top Step Size: 18" W x 16" D

Note: Ladder is not to be used as a work platform

**300-LB.
CAPACITY**



| Model No. | Number of Steps | Overall Height" | Platform Dim. H" x D" | Wt. lbs. |
|-----------|-----------------|-----------------|-----------------------|----------|
| VD441 | 4 | 78 | 37 x 16 | 73 |
| VD442 | 5 | 87 | 46 x 16 | 82 |
| VD443 | 6 | 95 | 55 x 16 | 92 |

TRAILER ACCESS ROLLING LADDERS

- Provides secure, safe access to cube vans/trailers
- All welded steel construction, ships fully assembled and ready to use
- Front walk through with chain/snap assembly
- Non-clogging slip resistant steps
- 10" flat-free wheels in rear
- Drop down handles in front for easy maneuvering
- Durable KLETON Blue enamel finish
- Made in accordance with the ANSI A14.7 safety standard
- Step Size: 22" x 8"

**300-LB.
CAPACITY**

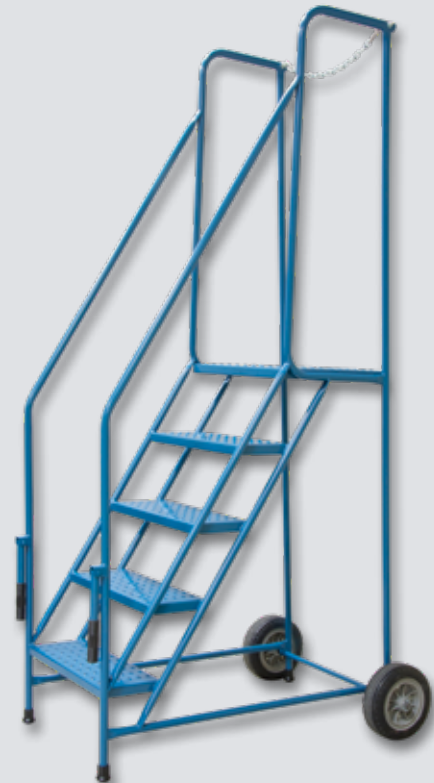

| Model No. | Number of Steps | Top Step Height" | Top Step W" x D" | Base Dimensions W" x D" | Wt. lbs. |
|-----------|-----------------|------------------|------------------|-------------------------|----------|
| M0010 | 4 | 37 | 22 x 16 | 33 x 40 | 78 |
| M0011 | 5 | 46 | 22 x 16 | 33 x 46 | 89 |
| M0012 | 6 | 55 | 22 x 16 | 33 x 51 | 100 |



ROLLING LADDERS WITH SPRING LOADED FRONT CASTERS

- Frame is welded 1" round steel tubing
- Ideal wherever there is a need to reach materials
- Rolls easily into position and locks firmly to the floor for maximum safety
- 2 to 6-step ladders operate on spring-loaded casters
- Casters retract under operators weight while rubber feet drop down
- First step on all 8 to 16-step ladders activates the floor locking mechanism (step off and kick release to make the ladder mobile)
- Non-clogging slip-resistant steel steps
- Durable KLETON blue enamel finish
- CSA certified to the ANSI standard A14.7

300-LB.
CAPACITY

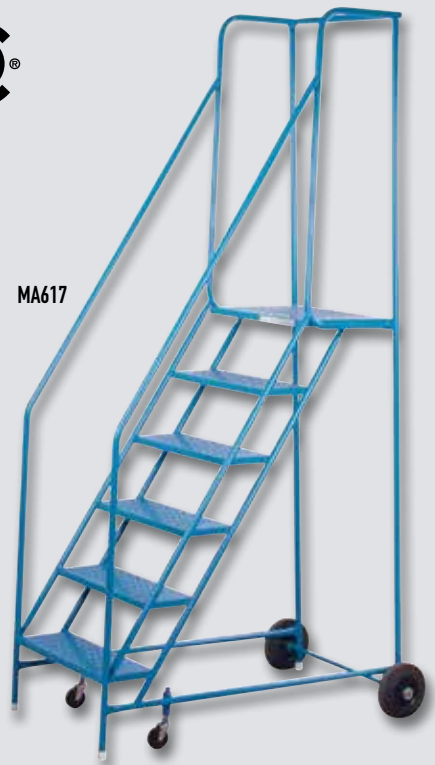

MA617

WITH SPRING-LOADED FRONT CASTERS

| Model No. | Number of Steps | Step Size W" x D" | Top Step Height" | Top Step W" x D" | Overall Base Dimensions W" x D" x H" | Wt. lbs. |
|-----------|-----------------|-------------------|------------------|------------------|--------------------------------------|----------|
| MA614 | 4 | 22 x 8 | 37 | 22 x 16 | 30 x 36 x 78 | 78 |
| MA616 | 5 | 22 x 8 | 46 | 22 x 16 | 30 x 46 x 87 | 89 |
| MA617 | 6 | 22 x 8 | 55 | 22 x 16 | 30 x 51 x 95 | 100 |

REPLACEMENT PARTS

- Model No. **MA790**, Spring Loaded 3" Swivel Caster
 Model No. **VC055**, Rubber Foot Tip
 Model No. **MH297**, Rubber 8" Wheel

ROLLING LADDERS WITH LOCKING STEP

- Frame is welded 1" round steel tubing
- Ideal wherever there is a need to reach materials
- Rolls easily into position and locks firmly to the floor for maximum safety
- 2 to 6-step ladders operate on spring-loaded casters
- Casters retract under operators weight while rubber feet drop down
- First step on all 8 to 16-step ladders activates the floor locking mechanism (step off and kick release to make the ladder mobile)
- Non-clogging slip-resistant steel steps
- Durable KLETON blue enamel finish
- CSA certified to the ANSI standard A14.7

300-LB.
CAPACITY

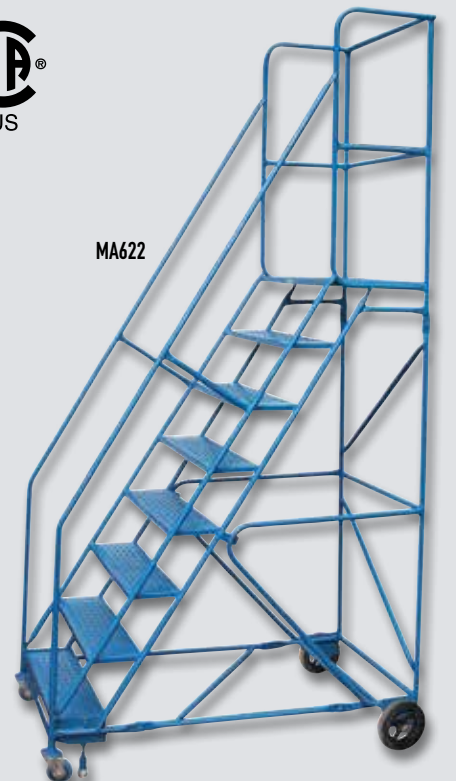

MA622

WITH SPRING-LOADED FRONT CASTERS

| Model No. | Number of Steps | Step Size W" x D" | Top Step Height" | Top Step W" x D" | Overall Base Dimensions W" x D" x H" | Wt. lbs. |
|-----------|-----------------|-------------------|------------------|------------------|--------------------------------------|----------|
| MA622* | 8 | 30 x 8 | 72 | 30 x 16 | 38 x 60 x 113 | 180 |
| MA623* | 10 | 30 x 8 | 89 | 30 x 16 | 38 x 72 x 130 | 230 |
| MA624* | 12 | 30 x 8 | 109 | 30 x 16 | 38 x 80 x 149 | 250 |
| MA625* | 14 | 30 x 8 | 128 | 30 x 16 | 38 x 93 x 167 | 275 |
| MA626* | 16 | 30 x 8 | 144 | 30 x 16 | 38 x 104 x 185 | 305 |

* Shipped knocked down, easy assembly

REPLACEMENT PARTS

- Model No. **MC305**, 4" Swivel Rubber Caster for Ladders 8-Step and up
 Model No. **VC055**, Rubber Foot Tip
 Model No. **MH297**, Rubber 8" Wheel

TILT-N-ROLL LADDERS

- Frame is welded 1" round steel tubing
- Balanced design allows ladder to tilt into the rolling position
- 30" high rails with 24" wide non-clogging slip resistant steps
- Oversize 24" x 24" top step for easier worker movement
- Legs have rubber tips that hold ladder secure during use
- Ladder moves easily on two 4" casters
- Non-clogging slip-resistant steel steps
- Durable KLETON blue enamel finish
- Meets ANSI standard A14.7
- Step Size: 22" x 8"
- Top Step Size: 22" x 24"

300-LB. CAPACITY

Optional Tool Tray



| Model No. | Number of Steps | Rise Height" | Top Step Height" | Height Top Rail" | Overall Dimensions W" x D" x H" | Wt. lbs. |
|-----------|-----------------|--------------|------------------|------------------|---------------------------------|----------|
| MD603 | 3 | 9 | 27 | 30 | 25 x 44 x 57 | 70 |
| MD604 | 4 | 9 | 38 | 30 | 25 x 50 x 68 | 81 |
| MD605 | 5 | 9 | 47 | 30 | 25 x 56 x 77 | 93 |
| MD606 | 6 | 9 | 56 | 30 | 25 x 62 x 86 | 105 |

REPLACEMENT PARTS

- Model No. **MH242**, Tool Tray (optional)
- Model No. **VC055**, Rubber Foot Tip
- Model No. **ML334**, 4" Rigid Rubber Caster

MECHANICS/MAINTENANCE ROLLING LADDERS

- Frame is welded 1" round steel tubing
- Double-straddle base puts worker in close proximity for hard-to-reach jobs
- Oversize 22" x 24" top step for easier worker movement
- Tilt and roll wheelbarrow style mobility allows easy movement over rough surfaces
- Removable 10" D x 24" W tool tray fits on front or side railing, included
- Non-clogging slip-resistant steel steps
- Durable KLETON blue enamel finish
- Meets ANSI standard A14.7
- Step Size: 22" x 8"
- Top Step Size: 22" x 24"

300-LB. CAPACITY

Includes removable 10"D x 24"W tool tray. Fits on front or side railing.



| Model No. | Number of Steps | Rise Height" | Top Step Height" | Height Top Rail" | Overall Dimensions W" x D" x H" | Wt. lbs. |
|-----------|-----------------|--------------|------------------|------------------|---------------------------------|----------|
| MH212 | 3 | 9 | 28 | 30 | 24 x 44 x 58 | 85 |
| MH213 | 4 | 9 | 38 | 30 | 24 x 50 x 68 | 98 |
| MH214 | 5 | 9 | 47 | 30 | 24 x 56 x 77 | 112 |
| MH215 | 6 | 9 | 57 | 30 | 24 x 68 x 87 | 125 |

REPLACEMENT PARTS

- Model No. **MH242**, Tool Tray (optional)
- Model No. **VC055**, Rubber Foot Tip
- Model No. **ML334**, 4" Rigid Rubber Caster

PORTABLE FOLDING LADDERS

- Foldable locking design saves on storage space when not in use
- Welded construction
- Easy to maneuver
- 58° slope, 7" deep steps for easy climbing
- Non-clogging slip-resistant steel steps
- Locks in the folded or climbing positions

350-LB. CAPACITY



| Model No. | Number of Steps | Top Step Height" | Open W" x L" | Folded Dimensions W" x D" x H" | Wt. lbs. |
|-----------|-----------------|------------------|--------------|--------------------------------|----------|
| VC436 | 2 | 20 | 24 x 17 | 24 x 10 x 41 | 30 |
| VC437 | 3 | 30 | 24 x 23 | 24 x 10 x 52 | 35 |
| VC438 | 4 | 40 | 24 x 30 | 24 x 10 x 65 | 42 |

REPLACEMENT PARTS

- Model No. **VC439**, 4" Polyurethane Wheel
- Model No. **VC440**, Rubber Foot Tip



MD444



KLETON High Work Maintenance Platform exceeds ASME B56.1 safety standard when a safety harness and lanyard are worn.

**1000-LB.
CAPACITY**

- All-welded design with a 14-gauge non-skid steel platform and 1-1/4" tubular steel frame
- Converts forklift trucks into a safe and efficient work platform
- Forks enter easily into channels and safety chains secure platform to fork carriage
- Welded safety gate is hinged to the platform
- 72" safety mesh back screen protects user from lift mechanism
- Durable KLETON blue enamel finish

| Model No. | Side Rails Height" | Fork Channel Openings" | Channels (Centre to Centre)" | Overall Dimensions W" x D" x H" | Wt. lbs. |
|-----------|--------------------|------------------------|------------------------------|---------------------------------|----------|
| MD444 | 42 | 7 x 3 | 26 | 36 x 36 x 72 | 230 |
| MH800 | 42 | 7 x 3 | 26 | 48 x 48 x 72 | 300 |

EMERGENCY STOP SWITCH

- Safety kill switch for person on work platform
- Will cut power to forklift in case of an emergency
- Consists of control box for platform, plug-in box (to be installed on forklift) and wire that extends 6' to 20'
- Switch is easy to install
- Recommended for maintenance platform model **MD444** and **MH800**

Model No. **MD328**

MD328
Emergency
Stop Switch

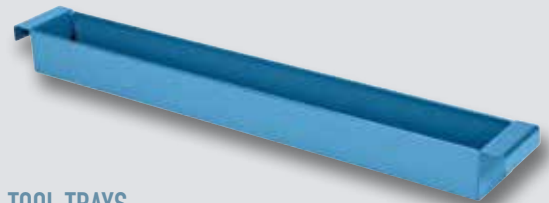

OPTIONAL TOOL TRAYS

| Model No. | Overall Dimensions W" x D" x H" | For Use with Model | Wt. lbs. |
|-----------|---------------------------------|--------------------|----------|
| MI787 | 36 x 4 x 3 | MD444 | 6 |
| MI788 | 46 x 4 x 3 | MH800 | 7 |

OPTIONAL LIGHT BULB CADDY

| Model No. | Overall Dimensions W" x D" x H" | Wt. lbs. | Price /Each |
|-----------|---------------------------------|----------|-------------|
| MD948 | 15 x 15 x 43 | 25 | 00.00 |

MD948
Optional Light
Bulb Caddy



OPTIONAL CASTER KIT

| Model No. | Description | Wt. lbs. |
|-----------|--|----------|
| MD338 | Two rigid 6" phenolic & two swivel 6" phenolic casters | 22 |

- Caster kit allows a person to move the platform around without the use of a forklift truck
- Compatible with both **MD444** and **MH800**

MAINTENANCE PLATFORMS

COLLAPSIBLE WORK PLATFORM

- Collapsible platform allows easy storage between use
- Convert forklift truck into safe work platform
- Eliminates the need of ladders and scaffolds for overhead maintenance
- Non-skid platform
- Safety mesh keeps operator away from lift mechanisms and equipment for added safety
- Forks slip easy into mounting pockets and are secured with chains for added security
- Frame material: Steel
- Overall Dimensions: 36" L x 36" W x 72" H
- Mesh backscreen height: 72"
- With gate
- Fork Channel Openings: 7" W x 3"H

Model No. MP522



MP522



1000-LB.
CAPACITY

MP522



KleTON builds quality and dependability into all of their products!
Look throughout the catalogue for the KleTON Custom Symbol indicating which products can be custom built to meet your specifications.

BUILT KLETON TOUGH



CUSTOMIZE . . .

- Strip Curtain Doors
- Platform Trucks
- Safety Guards
- Bollards
- Gas Cylinder Cabinets
- Workbenches
- Shelf Trucks
- And more...

***Call with your
specs today!***



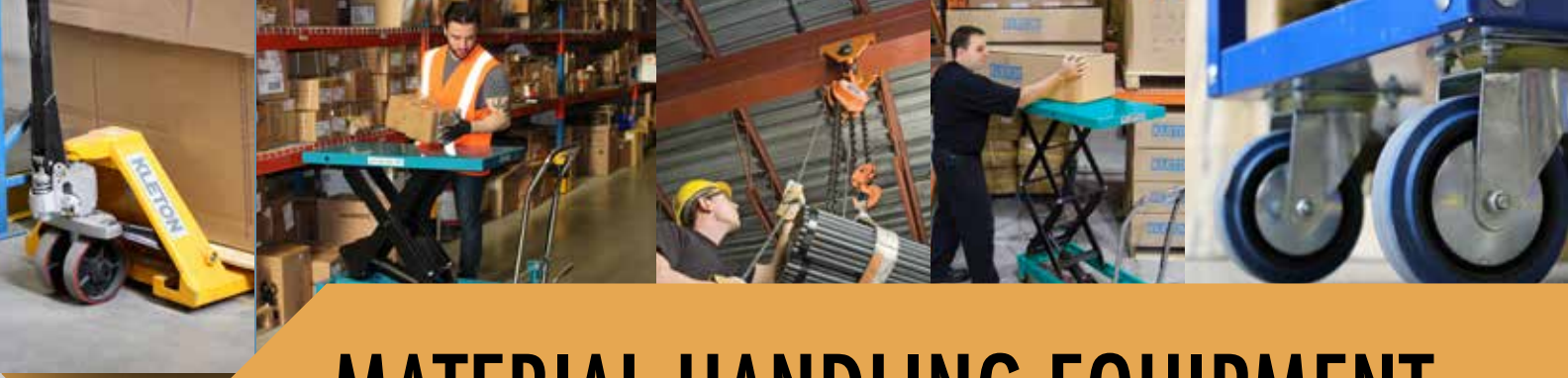

MATERIAL HANDLING EQUIPMENT

| | | | |
|--|---------|--------------------------------|-----------|
| Hydraulic Scissor Lift Tables | 60 - 61 | Shelf Trucks | 89 - 91 |
| Heavy Duty Hydraulic Scissor Lift Tables | 62 - 63 | Low Profile Shelf Trucks | 92 |
| Hydraulic Pallet Trucks | 64 - 67 | Stock Picking Trucks | 93 |
| Pallet Handling Equipment | 68 | Order Picking Trucks | 94 |
| Fork Extensions | 68 | Mobile Service Carts | 94 |
| Quick Links & Snap Hooks | 69 | Ergonomic Shelf Trucks | 95 |
| Hydraulic Platform Lift Stacker | 69 | Plastic Shelf Trucks | 96 |
| Pallet Pullers | 69 | Mail & Utility Carts | 97 |
| Spring Operated Pallet Lifter | 70 | Platform Trucks | 98 - 106 |
| Pallet Lifters | 71 | Platform Wagon Trucks | 102 |
| Hoists | 71 - 72 | Elevated Platform Trucks | 102 |
| Trolleys | 73 | Skids | 103 |
| Hand Trucks | 74 - 81 | Foldable Platform Trucks | 104 |
| Gas Cylinder Carts | 77 | Aluminum Platform Trucks | 105 - 106 |
| Aluminum Hand Trucks | 78 - 80 | Dollies | 107 - 109 |
| Specialized Hand Trucks | 81 | Specialized Carts | 110 - 113 |
| Tilt Trucks | 82 | Workhorses | 112 |
| Box Trucks | 83 - 85 | Casters | 114 - 117 |
| Self Dumping Hoppers | 83 | Wheel Chocks | 118 - 119 |
| Stock Trucks | 85 - 87 | Trailer Stabilizing Jack | 119 |
| Security Trucks | 88 | | |

HYDRAULIC SCISSOR LIFT TABLES

KLETON tables are available in various capacities and travels to satisfy a wide variety of applications. All tables have an integrated hydraulic pump/cylinder assembly. KLETON scissor lift tables add the value of mobility to the hydraulic lift table concept. Exceptional functionality and manoeuvrability is apparent, whether loaded or empty. In addition, rugged construction and premium-quality hydraulics complement their ease of use with low maintenance.

APPLICATIONS

KLETON tables are used in a wide variety of applications, from stocking shelves to lifting and moving materials in warehouses, machine shops and manufacturing operations.

FEATURES:

- Ergonomic push handle with easy to use release handle to lower the platform
- Hydraulic foot pump raises the platform

OPERATION

The KLETON design allows workers to easily move and position loads to a convenient working height. By minimizing undesirable lifting, reaching and stretching, KLETON tables increase productivity and decrease workplace injuries.

- Quality orange powder coated finish provides exceptional durability and corrosion resistance
- (2) Rigid 5" polyurethane casters
- (2) Swivel 5" polyurethane casters with brake
- Conforms to Machinery Directive 2006/42/EC



| Model No. | Platform Dimensions | Capacity lbs | Raised Height" | Lowered Height" | Total Pedal Strokes |
|-----------|---------------------|--------------|----------------|-----------------|---------------------|
| MP005 | 27-1/2" x 17-3/4" | 330 | 29.13 | 8.85 | 25 |



| Model No. | Platform Dimensions | Capacity lbs | Raised Height" | Lowered Height" | Total Pedal Strokes |
|-----------|---------------------|--------------|----------------|-----------------|---------------------|
| MP006 | 32" x 19-3/4" | 660 | 35.4 | 11 | 36 |



| Model No. | Platform Dimensions | Capacity lbs | Raised Height" | Lowered Height" | Total Pedal Strokes |
|-----------|---------------------|--------------|----------------|-----------------|---------------------|
| MP007 | 35-3/4" x 19-3/4" | 770 | 51.1 | 13.7 | 60 |



| Model No. | Platform Dimensions | Capacity lbs | Raised Height" | Lowered Height" | Total Pedal Strokes |
|-----------|---------------------|--------------|----------------|-----------------|---------------------|
| MP008 | 32" x 19-3/4" | 1100 | 35.4 | 11 | 45 |

HYDRAULIC SCISSOR LIFT TABLES

KLETON tables are available in various capacities and travels to satisfy a wide variety of applications. All tables have an integrated hydraulic pump/cylinder assembly. KLETON scissor lift tables add the value of mobility to the hydraulic lift table concept. Exceptional functionality and manoeuvrability is apparent, whether loaded or empty. In addition, rugged construction and premium-quality hydraulics complement their ease of use with low maintenance.

APPLICATIONS

KLETON tables are used in a wide variety of applications, from stocking shelves to lifting and moving materials in warehouses, machine shops and manufacturing operations.

FEATURES:

- Ergonomic push handle with easy to use release handle to lower the platform
- Hydraulic foot pump raises the platform

OPERATION

The KLETON design allows workers to easily move and position loads to a convenient working height. By minimizing undesirable lifting, reaching and stretching, KLETON tables increase productivity and decrease workplace injuries.

- Quality orange powder coated finish provides exceptional durability and corrosion resistance
- (2) Rigid 5" polyurethane casters
- (2) Swivel 5" polyurethane casters with brake
- Conforms to Machinery Directive 2006/42/EC



| Model No. | Platform Dimensions | Capacity lbs | Raised Height" | Lowered Height" | Total Pedal Strokes |
|-----------|---------------------|--------------|----------------|-----------------|---------------------|
| MP009 | 63" x 31-1/2" | 1100 | 35.4 | 12.2 | 55 |



| Model No. | Platform Dimensions | Capacity lbs | Raised Height" | Lowered Height" | Total Pedal Strokes |
|-----------|---------------------|--------------|----------------|-----------------|---------------------|
| MP010 | 39-1/2" x 20" | 1650 | 39.3 | 16.5 | 70 |



| Model No. | Platform Dimensions | Capacity lbs | Raised Height" | Lowered Height" | Total Pedal Strokes |
|-----------|---------------------|--------------|----------------|-----------------|---------------------|
| MP011 | 40" x 20" | 2200 | 39.3 | 14.9 | 55 |



| Model No. | Platform Dimensions | Capacity lbs | Raised Height" | Lowered Height" | Total Pedal Strokes |
|-----------|---------------------|--------------|----------------|-----------------|---------------------|
| MP012 | 48" x 24" | 1540 | 59 | 18.7 | 70 |

HEAVY-DUTY HYDRAULIC SCISSOR LIFT TABLES

FEATURES

- Heavy-duty construction with captured scissor rollers for maximum stability
- High-quality casters and wheels for exceptional roll ability (two fixed, two swivel)
- Superior hydraulic systems feature an integrated pump-cylinder for maximum reliability
- Ergonomic push handle with convenient lowering control
- Lowering control automatically stops when released for added safety
- Convenient maintenance pins secure the scissor legs for inspection and maintenance on Model **MJ525**
- Quality powder-coat finish provides exceptional durability and corrosion resistance
- Colour: KLETON Blue
- Features heavy-duty steel release handle

APPLICATIONS

KLETON tables are used in a wide variety of applications, from stocking shelves to lifting and moving materials in warehouses, machine shops and manufacturing operations.

OPERATION

The KLETON design allows workers to easily move and position loads to a convenient working height. By minimizing undesirable lifting, reaching and stretching, KLETON tables increase productivity and decrease workplace injuries.



MJ518 Collapsible Handle

FIND OUT HOW IT WORKS
www.Youtube.com/KletonInd



MJ519 & MJ521 Collapsible Handle



MJ519



MJ520

| Model No. | Load Cap lbs. | Platform Height Lowered" | Platform Height Raised" | Platform Size Width" | Platform Size Length" | Handle Height" | Pedal Strokes To Max | Wt. lbs. | Wheel Size |
|-----------|---------------|--------------------------|-------------------------|----------------------|-----------------------|----------------|----------------------|----------|------------|
| MJ518 | 330 | 8-5/8 | 29 | 17-3/4 | 27-1/2 | 36 | 28 | 95 | 4" |
| MJ519 | 660 | 11-1/4 | 34-5/8 | 19-3/4 | 32 | 39 | 27 | 170 | 5" |
| MJ520 | 770 | 14 | 51-1/4 | 19-3/4 | 35-3/4 | 39 | 53 | 199 | 5" |
| MJ521 | 1100 | 11-1/4 | 34-5/8 | 19-3/4 | 32 | 39 | 27 | 201 | 5" |

Note: Platform height lowered and raised includes the casters

HEAVY-DUTY HYDRAULIC SCISSOR LIFT TABLES

FIND OUT HOW IT WORKS
www.Youtube.com/KletonInd



| Model No. | Load Cap lbs. | Platform Height Lowered" | Platform Height Raised" | Platform Size Width" | Platform Size Length" | Handle Height" | Pedal Strokes To Max | Wt. lbs. | Wheel Size |
|-----------|---------------|--------------------------|-------------------------|----------------------|-----------------------|----------------|----------------------|----------|------------|
| MJ522 | 1100 | 11-1/4 | 36 | 31-7/8 | 63 | 39 | 55 | 398 | 5" |
| MJ523 | 1650 | 14-1/2 | 35-3/8 | 20-1/8 | 39-3/8 | 40 | 45 | 236 | 5.75" |
| MJ524 | 2200 | 15 | 39 | 20-1/8 | 40 | 39 | 82 | 212 | 5" |
| MJ525 | 2200 | 15 | 53-1/2 | 29-1/2 | 80-1/8 | 40 | 200 | 817 | 5" |
| MJ526 | 1545 | 17-1/2 | 59-1/8 | 24 | 48 | 40 | 97 | 400 | 5" |

Note: Platform height lowered and raised includes the casters

HYDRAULIC PALLET TRUCKS

HYDRAULIC PALLET TRUCKS

The 3-function hand control (raise, neutral and lower) and the spring loaded self-righting safety loop handle enhance comfort and ease of operation. Hardened chrome piston with protective dust cover for dependable performance. Durable powder coat finish.

- Heavy-duty polyurethane tread bonded to cast iron core steering wheels and rollers provide superior performance
- Heavy-duty plastic roller facilitates entry and exit of pallets
- 6-1/4" (158.75 mm) wide forks
- Lowered pallet truck height: 3-1/4"
- Raised pallet truck height: 7-3/4"
- Colour: Yellow
- Frame Material: Steel
- 1-year limited warranty

**5500-LB.
CAPACITY**



3-function hand control (raise, neutral and lower) and spring-loaded self-righting safety loop handle.



| Model No. | Overall Fork Dim. | |
|-----------|-------------------|---------|
| | Width" | Length" |
| ML966 | 20-1/2 | 36 |
| ML967 | 20-1/2 | 42 |
| ML968 | 20-1/2 | 48 |
| ML969 | 27 | 36 |
| ML970 | 27 | 42 |
| ML971 | 27 | 48 |
| ML972* | 27 | 48 |

*All nylon core steering wheels and rollers

HYDRAULIC PALLET TRUCKS



**5500-LB.
CAPACITY**

HEAVY-DUTY SERIES HYDRAULIC PALLET TRUCKS

- Heavy-duty polyurethane tread bonded to cast iron core steering wheels and rollers provide superior performance
- 6-1/4" (158.75 mm) wide forks
- Lowered pallet truck height: 2-7/8"
- Raised pallet truck height: 7-3/4"
- Colour: Orange

| Model No. | Overall Fork Dim. | |
|-----------|-------------------|---------|
| | Width" | Length" |
| MJ484 | 20-1/2 | 36 |
| MJ485 | 20-1/2 | 42 |
| MJ486 | 20-1/2 | 48 |
| MJ487 | 27 | 36 |
| MJ488 | 27 | 42 |
| MJ489 | 27 | 48 |
| ML372* | 27 | 48 |

* All nylon core steering wheels and rollers



**6600-LB.
CAPACITY**

HEAVY-DUTY SERIES HYDRAULIC PALLET TRUCKS

- Heavy-duty polyurethane tread bonded to cast iron core steering wheels and rollers provide superior performance
- Double rollers for easy moving of extra heavy loads
- Reinforced fork channels deliver exceptional durability
- 6-1/4" (158.75 mm) wide forks
- Lowered pallet truck height: 2-7/8"
- Raised pallet truck height: 7-3/4"
- Colour: KLETON blue

| Model No. | Overall Fork Dim. | |
|-----------|-------------------|---------|
| | Width" | Length" |
| MJ490 | 20 1/2 | 36 |
| MJ491 | 20 1/2 | 42 |
| MJ492 | 20 1/2 | 48 |
| MJ493 | 27 | 36 |
| MJ494 | 27 | 42 |
| MJ495 | 27 | 48 |
| ML373* | 27 | 48 |

* All nylon core steering wheels and rollers



**11000-LB.
CAPACITY**

SUPER HEAVY-DUTY HYDRAULIC PALLET TRUCK

- Heavy-duty nylon steering wheels and rollers provide maximum mobility and performance
- Double rollers for easy moving of extra heavy loads
- 2-year limited warranty
- Capacity: 11000 lbs.
- Fork Width: 6-1/4"
- Raised Height: 5.5"
- Lowered Height: 3"

| Model No. | Overall Fork Dim. | |
|-----------|-------------------|---------|
| | Width" | Length" |
| M0890 | 27 | 48 |

6' LONG FORK HYDRAULIC PALLET TRUCKS

- Heavy-duty polyurethane tread bonded to cast iron core steering wheels and rollers provide superior performance
- Nylon exit roller facilitates entry and exit of pallets
- 6-1/4" (158.75 mm) wide forks
- Lowered pallet truck height: 3"
- Raised pallet truck height: 7-5/8"
- Colour: Yellow

| Model No. | Overall Fork Dim. | | Capacity lbs. |
|-----------|-------------------|---------|---------------|
| | Width" | Length" | |
| MN723 | 27 | 72 | 3300 |
| MN459 | 27 | 72 | 5500 |



3300 LB - 5500 LB.
CAPACITY

GALVANIZED HYDRAULIC PALLET TRUCKS

- Heavy-duty all nylon steering wheels and rollers provide superior mobility and performance
- Nylon exit roller facilitates entry and exit of pallets
- 6-1/4" (158.75 mm) wide forks
- Lowered pallet truck height: 3"
- Raised pallet truck height: 7-1/16"
- Galvanized finish offers corrosion resistance and is ideal for wet and cold conditions

| Model No. | Overall Fork Dim. | |
|-----------|-------------------|---------|
| | Width" | Length" |
| MN648 | 27 | 42 |
| MN059 | 27 | 48 |



5500-LB.
CAPACITY

STAINLESS STEEL HYDRAULIC PALLET TRUCKS

- Heavy-duty all nylon steering wheels and rollers provide superior mobility and performance
- Nylon exit roller facilitates entry and exit of pallets
- 6-1/4" (158.75 mm) wide forks
- Lowered pallet truck height: 3"
- Raised pallet truck height: 7-1/16"
- High grade 304 Stainless steel is ideal for medical, food, sanitary, pharmaceutical, wet and cold applications

| Model No. | Overall Fork Dim. | |
|-----------|-------------------|---------|
| | Width" | Length" |
| MN060 | 27 | 48 |



5500-LB.
CAPACITY



5500-LB.
CAPACITY

LOW PROFILE HYDRAULIC PALLET TRUCKS

- Permits the handling of pallets and containers that are lower than the standard height
- Heavy-duty polyurethane tread bonded to cast iron core steering wheels
- and all steel rollers provide superior performance
- 1.5" exit ramp facilitates exit of pallets
- 6" (152 mm) wide forks
- Lowered pallet truck height: 2"
- Raised pallet truck height: 5-1/2"
- Colour: Orange

| Model No. | Overall Fork Dim. | |
|-----------|-------------------|---------|
| | Width" | Length" |
| MN061 | 27 | 48 |



5500-LB.
CAPACITY

MULTI-DIRECTIONAL HYDRAULIC PALLET TRUCKS

- Transrollers permit lateral movement in addition to forward/backward
- Heavy-duty polyurethane tread bonded to cast iron core steering wheels provide superior performance
- Double load rollers, one polyurethane tread bonded to cast iron core and one nylon for easy moving of extra heavy loads
- 2-1/5" exit ramp facilitates exit of pallets
- 6-1/4" (158.75 mm) wide forks
- Lowered pallet truck height: 3"
- Raised pallet truck height: 7-1/2"
- Capacity: Up to 5500 lbs. in standard mode, and up to 3300 lbs. in lateral mode
- Colour: Orange

| Model No. | Overall Fork Dim. | |
|-----------|-------------------|---------|
| | Width" | Length" |
| MN062 | 27 | 48 |



4400-LB.
CAPACITY

DIGITAL SCALE HYDRAULIC PALLET TRUCKS

- Permits the weighing of skids and containers while handling them
- Mettler Toledo digital cJL approved scale offers maximum precision on load weights
- Heavy-duty polyurethane tread bonded to cast iron core steering wheels and rollers provide superior performance
- Nylon roller facilitates entry and exit of pallets
- 6-5/8" (168 mm) wide forks
- Lowered pallet truck height: 3"
- Raised pallet truck height: 7-11/16"
- Colour: Orange

| Model No. | Overall Fork Dim. | |
|-----------|-------------------|---------|
| | Width" | Length" |
| MN705 | 27 | 44-1/2 |

FORK EXTENSIONS

- Handle large and odd shaped loads with increased stability
- Easy to use slide-on design
- Steel retaining strap prevents extensions from sliding off during use
- Fork extension not to exceed 50% more than existing fork length
- Available in 4", 5" and 6" widths, with lengths between 54" - 96"

| Model No. | Accommodates Fork Width" | Fork Extension Overall Width" | Length" | Wt. lbs. |
|-----------|--------------------------|-------------------------------|---------|----------|
| M0778 | 4 | 5 | 54 | 88 |
| M0779 | 4 | 5 | 63 | 102 |
| ML346 | 4 | 5 | 72 | 104 |
| M0780 | 4 | 5 | 84 | 135 |
| ML348 | 4 | 5 | 96 | 140 |
| ML347 | 5 | 6 | 72 | 116 |
| M0781 | 5 | 6 | 63 | 113 |
| M0782 | 5 | 6 | 84 | 138 |
| M0783 | 5 | 6 | 96 | 169 |
| M0784 | 6 | 7 | 72 | 140 |
| M0785 | 6 | 7 | 84 | 163 |
| M0786 | 6 | 7 | 96 | 184 |



WALL BRACKETS

- All welded heavy-duty
- To keep fork extensions out of the way when not in use
- One wall bracket required for each pair of forks
- KLETON safety yellow

| Model No. | Dimensions W" x H" | Wt. lbs. |
|-----------|--------------------|----------|
| ML282 | 6 x 8 | 5 |

Hardware not included



PALLET HANDLING EQUIPMENT

ZINC PLATED QUICK LINKS

- Multi-purpose connector
- Not approved for climbing applications



| Model No. | Working Load Limit | Size" |
|-----------|----------------------|-------|
| LW266 | 220 lbs (0.11 Tons) | 1/8 |
| LW267 | 660 lbs (0.33 Tons) | 3/16 |
| LW268* | 880 lbs (0.44 Tons) | 1/4 |
| LW269* | 1760 lbs (0.88 Tons) | 5/16 |
| LW270* | 2140 lbs (1.07 Tons) | 3/8 |
| LW271* | 3300 lbs (1.65 Tons) | 1/2 |

*Working load limit (WLL) stamped on each piece

SNAP HOOKS

- Multi-purpose connector
- Not approved for climbing applications



| Model No. | Material | Working Load Limit | Size" | Eye Size" |
|-----------|-----------------|----------------------|-------|-----------|
| LW272* | Stainless Steel | 220 lbs (0.11 Tons) | 3/16 | 5/16 |
| LW273 | Zinc Plated | 220 lbs (0.11 Tons) | 3/16 | 5/16 |
| LW274* | Stainless Steel | 260 lbs (0.13 Tons) | 1/4 | 3/8 |
| LW275* | Zinc Plated | 500 lbs (0.25 Tons) | 5/16 | 1/2 |
| LW276* | Stainless Steel | 500 lbs (0.25 Tons) | 5/16 | 1/2 |
| LW277* | Stainless Steel | 770 lbs (0.385 Tons) | 3/8 | 5/8 |

*Working load limit (WLL) stamped on each piece

HYDRAULIC PLATFORM LIFT STACKER

- Allow workers to manoeuvre and lift heavy loads safely to comfortable needed height
- Foot pedal folds safely out of the way
- Front 5" polyurethane casters and rear 3" polyurethane wheels allow loads to move easily
- Lowered platform height: 4"
- Raised platform height: 60"
- Capacity: 880 lbs.

| Model No. | Overall Dimensions W" x D" x H" | Platform Dimensions W" x D" | Wt. lbs. |
|-----------|------------------------------------|--------------------------------|-------------|
| MN397 | 23 x 39 x 67-3/4 | 23 x 25-3/4 | 189 |



PALLET PULLERS

- Efficient way to unload pallets from trucks
- Hardened teeth give positive grip in any pallet
- One-person operation
- Pulls pallets straight or sideways to get out of tight spots

| Model No. | Description | Wt. lbs. |
|-----------|--------------------|-------------|
| KH863 | Pallet Puller | 16 |
| *LU982 | 20' Hook and Chain | 21 |

*Chain Capacity of 4700 lbs



Model LU982
OPTIONAL 20' HOOK AND CHAIN



KH863

5000-LB.
CAPACITY

SPRING-OPERATED PALLET LIFTER

- Shock absorber and heavy-duty springs allow the top of the load to remain at a convenient height by raising and lowering the pallet as its weight changes
- Equipped with forklift pockets for easy relocation
- Rotating top minimizes worker movement
- Ergonomic design helps prevent workplace injuries
- Base Frame Dimensions: 45-1/4" L x 36-3/4" W
- Platform Dimensions: 43-5/8" L x 43-5/8" W
- Easy to assemble
- Capacity: 4400 lbs.
- Raised Height: 27.75"
- Lowered Height: 9.5"
- Frame Material: Steel

Model No. **M0787**



KLETON

CHAIN HOISTS

- Lightweight steel construction
- Triple-spur geared for easy lifting
- Load brake assures safety and load control
- High tensile alloy steel load chain for increased strength and durability for added security
- Latched swivel hooks for added security
- Enclosed chain guide ensures dirt and dust do not affect operation

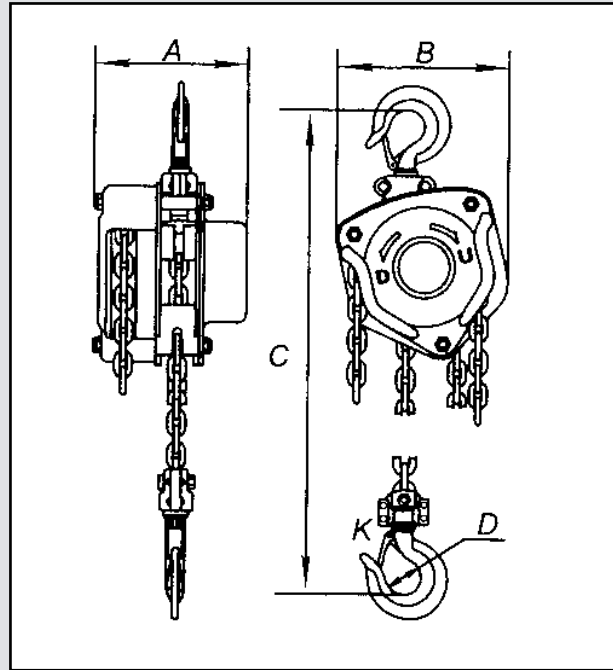

| Model No. 10' Lift | Model No. 20' Lift | Capacity | | | Net Weight | | No. of Falls Chain | Load Chain Dia. | | Headroom | |
|-----------------------|-----------------------|----------|-------|------|------------|------|-----------------------|-----------------|----|----------|-----|
| | | Tons | lbs. | kg. | lbs. | kg | | in. | mm | in. | mm |
| LS534 | LS540 | 1/2 | 1000 | 450 | 22.5 | 10.2 | 1 | 1/4 | 6 | 10-1/2 | 270 |
| LS535 | LS541 | 1 | 2000 | 900 | 28 | 12.7 | 1 | 1/4 | 6 | 12-1/2 | 317 |
| LS536 | LS542 | 1-1/2 | 3000 | 1360 | 38.5 | 17.5 | 1 | 5/16 | 8 | 15-3/4 | 399 |
| LS537 | LS543 | 2 | 4000 | 1800 | 42 | 19 | 1 | 5/16 | 8 | 16-1/4 | 414 |
| LS538 | LS544 | 3 | 6000 | 2720 | 55.7 | 25.3 | 2 | 5/16 | 8 | 18-1/4 | 465 |
| LS539 | LS545 | 5 | 10000 | 4530 | 95 | 43 | 2 | 7/16 | 10 | 25 | 636 |

| Model No. 10' Lift | Model No. 20' Lift | A | | B | | C | | D | | K | |
|-----------------------|-----------------------|-------|-----|-------|-----|--------|-----|-------|----|--------|----|
| | | in. | mm | in. | mm | in. | mm | in. | mm | in. | mm |
| LS534 | LS540 | 5-1/4 | 131 | 5 | 127 | 10-1/2 | 270 | 1-3/8 | 36 | 1-3/16 | 30 |
| LS535 | LS541 | 5-1/2 | 140 | 6-1/4 | 158 | 12-1/2 | 317 | 1-5/8 | 40 | 1-1/4 | 34 |
| LS536 | LS542 | 6-1/4 | 161 | 7-1/4 | 187 | 15-3/4 | 399 | 1-3/4 | 45 | 1-1/2 | 38 |
| LS537 | LS543 | 6-1/4 | 161 | 7-1/4 | 187 | 16-1/4 | 414 | 2 | 50 | 1-5/8 | 41 |
| LS538 | LS544 | 6-1/4 | 161 | 8-1/4 | 210 | 18-1/4 | 465 | 2-1/4 | 58 | 1-7/8 | 48 |
| LS539 | LS545 | 7-1/4 | 186 | 10 | 253 | 25 | 636 | 2-1/2 | 64 | 2 | 52 |

*Dimensions are approximate and should be confirmed if important to your application

LEVER HOISTS

LEVER HOISTS

- Lightweight steel construction
- Short steel handle rotates 360° to allow operation in any position
- Load brake assures safety and load control
- High tensile alloy steel load chain for increased strength and durability
- Latched swivel hooks for added security
- Enclosed chain guide ensures dirt and dust do not affect operation

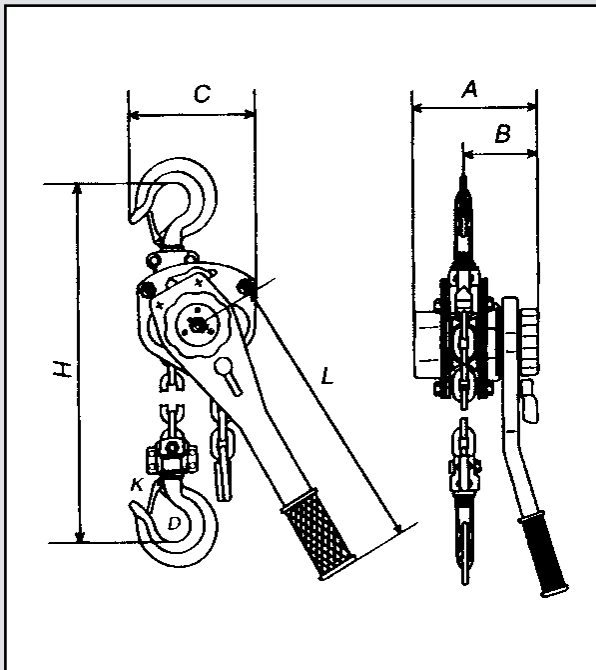

| Model No. | Capacity | | | Net Weight | | No. of FallsChain | Load Chain Dia. | |
|-----------|----------|-------|------|------------|-----|-------------------|-----------------|----|
| | Tons | lbs. | kg. | lbs. | kg. | | in. | mm |
| LS546 | 3/4 | 1500 | 680 | 15.5 | 7 | 1 | 1/4 | 6 |
| LS547 | 1 | 2000 | 900 | 17.6 | 8 | 1 | 1/4 | 6 |
| LS548 | 1-1/2 | 3000 | 1360 | 24 | 11 | 1 | 5/16 | 8 |
| LS549 | 3 | 6000 | 2720 | 46 | 21 | 1 | 7/16 | 10 |
| LS550 | 6 | 12000 | 5440 | 68 | 31 | 2 | 7/16 | 10 |

| Model No. | A | | B | | C | | D | | H | | L | | K | |
|-----------|-------|-----|-------|-----|-------|-----|-------|----|--------|-----|-----|-----|--------|----|
| | in. | mm | in. | mm | in. | mm | in. | mm | in. | mm | in. | mm | in. | mm |
| LS546 | 5-3/4 | 148 | 3-1/2 | 90 | 5-1/4 | 136 | 1-1/2 | 40 | 12-3/4 | 325 | 11 | 280 | 1-5/16 | 34 |
| LS547 | 5-3/4 | 148 | 3-1/2 | 90 | 5-1/4 | 136 | 1-1/2 | 40 | 12-3/4 | 325 | 11 | 280 | 1-5/16 | 34 |
| LS548 | 6-3/4 | 172 | 3-3/4 | 98 | 6-1/4 | 160 | 1-3/4 | 45 | 15 | 380 | 16 | 410 | 1-7/16 | 38 |
| LS549 | 7-3/4 | 200 | 4-1/2 | 115 | 7 | 180 | 2-1/4 | 58 | 18-3/4 | 480 | 16 | 410 | 1-7/8 | 48 |
| LS550 | 7-3/4 | 200 | 4-1/2 | 115 | 9-1/4 | 235 | 2-1/2 | 64 | 24-1/2 | 620 | 16 | 410 | 2-1/16 | 52 |

* Dimensions are approximate and should be confirmed if important to your application

ADJUSTABLE TROLLEYS

PLAIN TROLLEYS



- Easily adjusts to fit various flanges and I-beams
- Use on straight or curved track
- Can be installed or removed at any position on the beam
- Heavy-duty cast iron wheels
- Safety plate included
- Deep width flange provides superior contact with the beam

| Model No. | Capacity | | | I-Beam Flange Width | | Min. Curve Radius | | Net Weight | |
|-----------|----------|-------|------|---------------------|---------|-------------------|------|------------|------|
| | Tons | lbs. | kg | in. | mm | in. | mm | lbs. | kg |
| LS551 | 1/2 | 1000 | 450 | 2-11/16 - 5-3/8 | 68-136 | 35-7/16 | 900 | 10 | 4.4 |
| LS552 | 1 | 2000 | 900 | 3-1/8 - 6-1/4 | 80-158 | 39-3/8 | 1000 | 17 | 7.5 |
| LS553 | 2 | 4000 | 1800 | 3-1/8 - 6-1/4 | 80-158 | 43-5/16 | 1100 | 28 | 12.5 |
| LS554 | 3 | 6000 | 2720 | 3-7/16 - 7-3/8 | 88-188 | 51-3/16 | 1300 | 46 | 20.6 |
| LS555 | 5 | 10000 | 4530 | 4-13/16 - 9-9/16 | 122-243 | 66-15/16 | 1700 | 73 | 33 |

* Dimensions are approximate and should be confirmed if important to your application

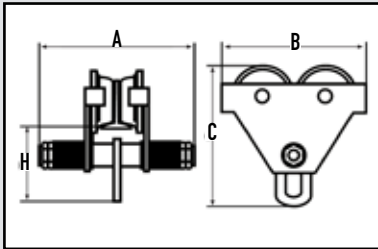

| Model No. | Capacity Tons | A | | B | | C | | H | |
|-----------|---------------|----------|-----|----------|-------|---------|-------|---------|-------|
| | | in. | mm | in. | mm | in. | mm | in. | mm |
| LS551 | 1/2 | 8-3/16 | 208 | 8 | 202.4 | 7-3/8 | 187 | 4-59/64 | 125 |
| LS552 | 1 | 9-1/2 | 242 | 9-11/64 | 233 | 7-3/4 | 197.7 | 5 | 127.5 |
| LS553 | 2 | 9-27/32 | 250 | 10-11/32 | 262.6 | 9-23/64 | 237.5 | 5-53/64 | 148 |
| LS554 | 3 | 11-13/16 | 300 | 11-3/4 | 298 | 11-7/8 | 301 | 7-23/32 | 196 |
| LS555 | 5 | 13-1/2 | 343 | 13-3/4 | 349 | 13-3/8 | 340 | 8-37/64 | 218 |

GEARED TROLLEYS



- Easily adjusts to fit various flanges and I-beams
- Use on straight or curved track
- Can be installed or removed at any position on the beam
- Heavy-duty cast iron wheels
- Safety plate included
- Deep width flange provides superior contact with the beam
- Geared trolleys include 2 geared wheels operated by hand chain

| Model No. | Capacity | | | I-Beam Flange Width | | Min. Curve Radius | | Net Weight | |
|-----------|----------|-------|------|---------------------|---------|-------------------|------|------------|------|
| | Tons | lbs. | kg | in. | mm | in. | mm | lbs. | kg |
| LS556 | 1/2 | 1000 | 450 | 2-11/16 - 5-1/4 | 68-134 | 35-7/16 | 900 | 18 | 8 |
| LS557 | 1 | 2000 | 900 | 3-1/8 - 5-15/16 | 80-150 | 39-3/8 | 1000 | 25 | 11.5 |
| LS558 | 2 | 4000 | 1800 | 3-1/8 - 7-1/16 | 80-180 | 43-5/16 | 1100 | 36 | 16.5 |
| LS559 | 3 | 6000 | 2720 | 3-7/16 - 7-3/8 | 88-188 | 51-3/16 | 1300 | 54 | 24.5 |
| LS560 | 5 | 10000 | 4530 | 4-3/4 - 7-3/4 | 120-196 | 55-1/8 | 1400 | 81 | 36.6 |

* Dimensions are approximate and should be confirmed if important to your application

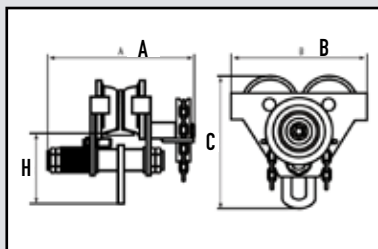

| Model No. | Capacity Tons | A | | B | | C | | H | |
|-----------|---------------|--------|-----|---------|-------|----------|-----|---------|-----|
| | | in. | mm | in. | mm | in. | mm | in. | mm |
| LS556 | 1/2 | 9-3/4 | 248 | 8 | 202.5 | 7-13/32 | 188 | 4-59/64 | 125 |
| LS557 | 1 | 11 | 280 | 9-1/4 | 235 | 7-3/4 | 197 | 4-31/32 | 126 |
| LS558 | 2 | 12-1/2 | 318 | 10-5/32 | 258 | 9-3/8 | 238 | 5-29/32 | 150 |
| LS559 | 3 | 13-3/8 | 340 | 11-1/2 | 293 | 11-3/4 | 298 | 7-31/64 | 190 |
| LS560 | 5 | 14-3/8 | 365 | 13-3/4 | 350 | 13-11/32 | 339 | 8-5/8 | 219 |

RUBBER WHEEL HAND TRUCKS

600-LB. CAPACITY

- Constructed of 1" 16-gauge steel tube
- Nose plate 7-gauge steel
- Overall width: 19-1/2"
- Wheel dimensions: 8"H x 2"W
- Powder-coated paint



| Model No. | Description | Height" | Nose Plate Dim. | | Wt. lbs. |
|--------------|-------------------|---------|-----------------|--|----------|
| | | | W" x D" | | |
| MK728 | Continuous Handle | 46 | 14 x 8-1/2 | | 27 |
| MK729 | Dual Handle | 48 | 14 x 8-1/2 | | 29 |
| MN103 | P-Handle | 51 | 14 x 9 | | 29 |

REPLACEMENT PARTS

Model No. **ML812**, Rubber Wheel
Model No. **MK993**, Hand Grip

PNEUMATIC WHEEL HAND TRUCKS

600-LB. CAPACITY

- Constructed of 1" 16-gauge steel tube
- Nose plate 8 gauge steel
- Overall width: 21-1/2"
- Wheel dimensions: 10"H x 3"W
- Powder-coated paint



| Model No. | Description | Height" | Nose Plate Dim. | | Wt. lbs. |
|--------------|-------------------|---------|-----------------|--|----------|
| | | | W" x D" | | |
| MH300 | Dual Handle | 46 | 14 x 9 | | 24 |
| MH301 | Continuous Handle | 48 | 14 x 9 | | 22.5 |
| MH302 | P-Handle | 51 | 14 x 9 | | 26.5 |

REPLACEMENT PARTS

Model No. **ML810**, Pneumatic Wheel
Model No. **MK993**, Hand Grip

FLAT FREE WHEEL HAND TRUCKS

600-LB. CAPACITY

- Constructed of 1" 16-gauge steel tube
- Nose plate 8-gauge steel
- Overall width: 22"
- Wheel dimensions: 10"H x 3-1/2"W
- Powder-coated paint



| Model No. | Description | Height" | Nose Plate Dim. | | Wt. lbs. |
|--------------|-------------------|---------|-----------------|--|----------|
| | | | W" x D" | | |
| MN389 | Dual Handle | 46 | 14 x 9 | | 25.5 |
| MN390 | Continuous Handle | 48 | 14 x 9 | | 24 |
| MN391 | P-Handle | 51 | 14 x 9 | | 28 |

REPLACEMENT PARTS

Model No. **MN378**, Flat Free Wheel
Model No. **MK993**, Hand Grip

HEAVY-DUTY RUBBER WHEEL HAND TRUCKS

- Constructed of 1-1/4" 14-gauge steel tube
- Nose plate 6-gauge steel
- Overall width: 20"
- Wheel dimensions: 8"H x 2"W
- Powder-coated paint

**1000-LB.
CAPACITY**

| Model No. | Description | Height" | Nose Plate Dim. W" x D" | Wt. lbs. |
|--------------|-------------------|---------|-------------------------|----------|
| M0119 | Continuous Handle | 50 | 14 x 8-3/4 | 50 |
| MK730 | Dual Handle | 46 | 14 x 8 | 32 |
| M0121 | P-Handle | 50-3/4 | 14 x 8-3/4 | 50 |

REPLACEMENT PARTS

Model No. **ML813**, Rubber Wheel
Model No. **MK993**, Hand Grip



HEAVY-DUTY PNEUMATIC WHEEL HAND TRUCKS

- Constructed of 1-1/4" 14-gauge steel tube
- Nose plate 6-gauge steel
- Overall width: 20"
- Wheel dimensions: 10"H x 3"W
- Powder-coated paint

**800-LB.
CAPACITY**

| Model No. | Description | Height" | Nose Plate Dim. W" x D" | Wt. lbs. |
|--------------|-------------------|---------|-------------------------|----------|
| M0120 | Continuous Handle | 50 | 14 x 8-3/4 | 47 |
| MK731 | Dual Handle | 46 | 14 x 8 | 25 |
| M0122 | P-Handle | 50 3/4 | 14 x 8-3/4 | 47 |

REPLACEMENT PARTS

Model No. **ML811**, Pneumatic Wheel
Model No. **MK993**, Hand Grip



TRAFFIC CONE CART

- Constructed of 1" round heavy-duty 14 gauge steel tubing
- Holds up to 25 standard or reflective cones from 12" to 28" in height
- Overall width: 22-1/2"
- Wheel dimensions: 10"H x 3"W
- Powder-coated paint

**500-LB.
CAPACITY**

| Model No. | Overall Dimensions W" x D" x H" | Load Capacity lbs. | Wt. lbs. |
|--------------|---------------------------------|--------------------|----------|
| M0214 | 22-1/2 x 20 x 45 | 500 | 32 |



Safely and easily transports traffic cones with little effort!

M0214

HAND TRUCKS

CAUTION For worker safety and in order to protect your equipment please be advised that all hand trucks on this page are not meant for use on stairs or steps. Please see our Appliance Trucks on Page 81 or Aluminum Hand Trucks on Pages 78-80



CONVERTIBLE DELUXE STEEL HAND TRUCK

- Constructed of 1" round 14-gauge steel tubing
- Quickly converts from a two-wheel hand truck to a four-wheel platform truck
- Remove hitch pins on either side to quickly converts from a 800 lb. capacity platform truck to a 600 lb. capacity hand truck
- Comes with two welded-on stair glides
- 8" x 14" nose plate
- Two 10" full pneumatic wheels and two 3" bolted-on casters
- Durable KLETON blue enamel finish



800-LB. CAPACITY

| Model No. | Overall Dimensions W" x D" x H" | Wt. lbs. |
|-----------|---------------------------------|----------|
| ML320 | 14 x 43 x 45 | 58 |

DELUXE 12" NOSE PLATE HAND TRUCKS

- Constructed of 1" round 14-gauge steel tubing
- Transport short to tall loads easily
- P-handle ideal for one hand control
- Strong 12" x 14" x 3/16" thick nose plate
- Double welded 3/16" x 1-1/2" cross bars
- Add a folding nose extension to be able to transport larger loads
- Two 10" full pneumatic wheels
- Durable KLETON blue enamel finish

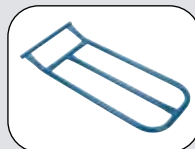

Model ML323 Nose Extension

700-LB. CAPACITY

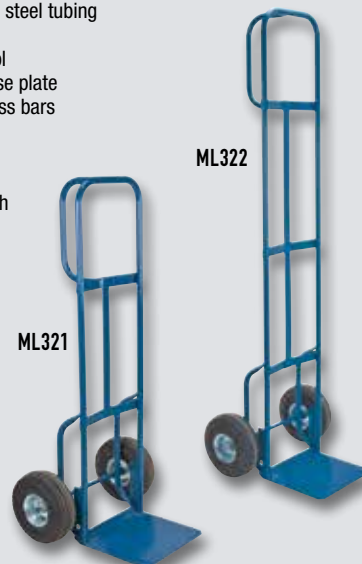

| Model No. | Description | Overall Dimensions W" x H" | Wt. lbs. |
|-----------|----------------|----------------------------|----------|
| ML321 | Lo-Boy | 23 x 50 | 40 |
| ML322 | Hi-Boy | 23 x 72 | 42 |
| ML323 | Nose extension | 12" x 22" Nose Length | 7.75 |

HEAVY-DUTY SPADE TRUCK

- Constructed of double-welded 1-1/4" round 14-gauge steel tubing
- Constructed of double-welded 1-1/4" round 14-gauge steel tubing
- Remove hitch pins on either side to quickly converts from a 800 lb. capacity platform truck to a 600 lb. capacity hand truck
- Tapered 22" x 1/4" x 13" deep thick nose plate
- Two 10" Mold-on rubber wheels
- Durable KLETON blue enamel finish



1200-LB. CAPACITY

| Model No. | Dimensions W" x H" | Wt. lbs. |
|-----------|--------------------|----------|
| ML324 | 22" x 53" | 68 |

HAND TRUCK ATTACHMENTS

- Constructed of 1" round, 14-gauge steel tubing
- Allows extra versatility to adapt to changing material handling requirements without the extra cost
- Easy to install
- Designed to fit most hand trucks with a 14" frame width
- Durable KLETON blue enamel finish

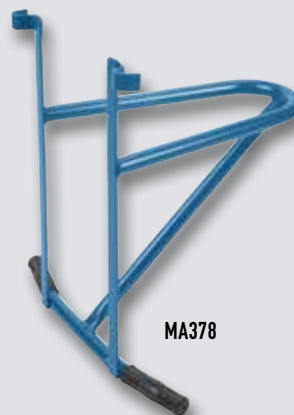

| Model No. | Description | Wt. lbs. |
|-----------|------------------------|----------|
| MA378 | Chair Mover Attachment | 7.25 |
| MA385 | Table Mover Attachment | 12 |

LOAD RETENTION HAND TRUCK

- Constructed of 1" round 14-gauge steel tubing
- 18-1/2" x 53" load retention grill to safely handle wide and awkward loads
- 7-gauge steel nose plate
- 18-1/2" x 9-3/4" nose plate
- Two 10" full pneumatic wheels
- Durable KLETON blue enamel finish

Model No. **MN412**



MN412

600-LB. CAPACITY

MINI-MIG WELDING CART

- Designed to carry a variety of Mini-MIG, Inverters, and Plasma machines
- Dimensions: 18" W x 36" D x 17" H
- Weight: 49 lbs.
- Cylinder Capacity: 9.5"

Model No. **ML419**



ML419

1000-LB. CAPACITY

HEAVY-DUTY DUAL HANDLE HAND TRUCK

- Constructed of 1-1/4" 14-gauge steel tubing
- 6-gauge steel 12" x 8" nose plate
- Overall width: 20"
- Overall height: 52"
- Weight: 40 lbs.
- Two 10" rubber wheels
- Powder coated

Model No. **MA376**



1000-LB. CAPACITY

REPLACEMENT PARTS

Model No. **MN694**, Rubber Wheel
Model No. **ML030**, Hand Grip

GAS CYLINDER CARTS

- Choice of carts for a wide range of cylinder sizes and terrains.



ML414



ML416



ML417

| Model No. | Wt. lbs. | Base W" x D" | Wheels | Capacity |
|-----------|----------|--------------|-----------------------------|--|
| ML413 | 42 | 25 x 13 | 16" Diameter Pneumatic | 224 cu. ft. Oxygen, 300 cu.ft Acetylene Cylinders |
| ML414 | 40 | 12 x 10 | 10" Diameter Semi-Pneumatic | 300 cu. ft. 9" Diameter Cylinder |
| ML415 | 40 | 25 x 13 | 14" Diameter x 3" Rubber | 244 cu. ft. Oxygen, 300 cu. ft. Acetylene Cylinders |
| ML416 | 40 | 12 x 16 | 10" Diameter Semi-Pneumatic | 144 cu. ft. or 244 cu. ft. Oxygen, 130 cu. ft. Acetylene Cylinders |
| ML417 | 42 | 19 x 10 | 10" Diameter Semi-Pneumatic | 144 cu. ft. or 244 cu.ft. Oxygen, 130 cu. ft. Acetylene Cylinders |

ALUMINUM HAND TRUCKS

HAND TRUCK ACCESSORIES

NOSE EXTENSIONS

- Size 20"
 - Only compatible with cast nose plates
- Model No. **MN019**



STAIR CLIMBERS

Model No. **MN015**



FRAME EXTENSIONS

Size: 17"
Model No. **MN021**
Size: 23"
Model No. **MN022**



REPLACEMENT WHEELS



10" PNEUMATIC
Model No. **MN012**



8" MOLD-ON RUBBER
Model No. **MN013**



10" FLAT-FREE
Model No. **MN014**

RUBBER WHEEL ALUMINUM HAND TRUCKS

- Strong lightweight hand truck provides exceptional durability and versatility
- Weld-free construction for easy maintenance
- Wheel Size: 8" H x 2" W
- Capacity: 500 lbs.
- Shipped knocked down



| Model No. | Handle Type | Overall Dimensions W" x H" | Nose Plate Dimensions W" x D" |
|--------------|-------------|----------------------------|-------------------------------|
| M0073 | P-Handle | 14 x 52 | 14 x 7-1/2 |
| MN027 | P-Handle | 21 x 48 | 18 x 7-1/2 |
| MN024 | Continuous | 16 x 48 | 14 x 7-1/2 |

| Model No. | Handle Type | Overall Dimensions W" x H" | Nose Plate Dimensions W" x D" |
|--------------|-------------|----------------------------|-------------------------------|
| MN025 | Continuous | 20 x 48 | 18 x 7-1/2 |
| M0891 | Dual Handle | 20 x 52 | 18 x 7-1/2 |
| M0892 | Continuous | 20 x 48 | 18 x 7-1/2 |

ALUMINUM HAND TRUCKS

FLAT-FREE WHEEL ALUMINUM HAND TRUCKS

- Strong lightweight hand truck provides exceptional durability and versatility
- Weld-free construction for easy maintenance
- Wheel Size: 10" H x 3" W
- Capacity: 500 lbs.
- Shipped knocked down



M0080



M0078



M0077



M0896



M0075



M0072



MN032



MN029



M0898

| Model No. | Handle Type | Overall Dimensions W" x H" | Nose Plate Dimensions W" x D" |
|-----------|-------------|----------------------------|-------------------------------|
| M0080 | P-Handle | 18 x 52 | 18 x 7-1/2 |
| M0078 | Continuous | 14 x 48 | 14 x 7-1/2 |
| M0077 | Continuous | 18 x 48 | 18 x 10 |
| M0896 | Continuous | 18 x 48 | 18 x 7-1/2 |

| Model No. | Handle Type | Overall Dimensions W" x H" | Nose Plate Dimensions W" x D" |
|-----------|-------------|----------------------------|-------------------------------|
| M0075 | Continuous | 14 x 52 | 14 x 7-1/2 |
| M0072 | Dual Handle | 18 x 52 | 18 x 7-1/2 |
| MN032 | Dual Handle | 18 x 52 | 18 x 10 |
| MN029 | P-Handle | 18 x 52 | 18 x 7-1/2 |
| M0898 | P-Handle | 16 x 52 | 14 x 7-1/2 |

ALUMINUM HAND TRUCKS

PNEUMATIC WHEEL ALUMINUM HAND TRUCKS

- Weld-free construction for easy maintenance
- Strong and lightweight hand truck provides exceptional durability and versatility
- Shipped knocked down
- Wheel Size: 10" H x 3" W
- Capacity: 500 lbs.
- Shipped knocked down



| Model No. | Handle Type | Overall Dimensions W" x H" | Nose Plate Dimensions W" x D" |
|-----------|-------------|----------------------------|-------------------------------|
| M0079 | P-Handle | 18 x 52 | 18 x 7-1/2 |
| M0076 | Continuous | 18 x 48 | 18 x 10 |
| M0074 | P-Handle | 14 x 52 | 14 x 7-1/2 |
| M0071 | Dual Handle | 18 x 52 | 18 x 7-1/2 |
| M0893 | Continuous | 16 x 48 | 14 x 7-1/2 |
| M0894 | P-Handle | 18 x 52 | 18 x 7-1/2 |

| Model No. | Handle Type | Overall Dimensions W" x H" | Nose Plate Dimensions W" x D" |
|-----------|-------------|----------------------------|-------------------------------|
| MN026 | Continuous | 16 x 52 | 14 x 7-1/2 |
| MN030 | Dual Handle | 16 x 52 | 14 x 7-1/2 |
| MN031 | Dual Handle | 18 x 52 | 18 x 10 |
| MN033 | Dual Handle | 21 x 52 | 18 x 7-1/2 |
| M0895 | Continuous | 16 x 48 | 14 x 7-1/2 |
| MN028 | P-Handle | 18 x 52 | 18 x 7-1/2 |

SPECIALIZED HAND TRUCKS

CONVERTIBLE HAND TRUCKS

- Converts easily from a 2-wheel hand truck to a 4-wheel platform truck
- Lightweight aluminum construction
- Caster and wheel type: Flat-free
- **MP503:** 5" polyurethane casters and 10" Pneumatic wheels
- **MP504:** 5" polyurethane casters and 10" Flat-free wheels
- Shipped assembled

| Model No. | Nose Plate W" x D" | Hand Truck | | Platform Truck | | Wt. lbs. |
|-----------|--------------------|------------|------|----------------|---------|----------|
| | | Cap. lbs. | Ht." | Cap. lbs. | L" x W" | |
| MP503 | 18 x 10 | 600 | 52 | 1250 | 43 x 12 | 46,5 |
| MP504 | 18 x 7-1/2 | 550 | 62 | 800 | 56 x 20 | 42 |



APPLIANCE TRUCKS

- Move large appliances easily
- Heavy-duty all welded industrial construction
- Vinyl bumpers on face of truck to prevent damage to appliances
- Heavy-duty continuous stair climbers for easy climbing/descending
- 8" solid rubber front wheels
- **ML617** comes with fold out rear legs with two 4" swivel casters
- Ratchet mechanism for easy fastening of loads



| Model No. | Description | Overall Dimensions L" x W" X H" | Cap. lbs. | Wt. lbs. |
|-----------|---------------------------------|---------------------------------|-----------|----------|
| ML616 | Appliance Truck | 14-1/2" x 24" x 59" | 550 | 46 |
| ML617 | Vending Machine Appliance Truck | 14-1/2" x 24" x 66" | 850 | 65 |
| MP505 | Appliance Truck | 14" x 24" x 59" | 750 | 45 |

FOLDING ALUMINUM HAND TRUCK

- Lightweight and durable aluminum construction
- Convenient folding design permits storage in small spaces
- Comfortable ergonomic handle
- Elastic straps help to secure load
- Non-marking and shock-absorbing rubber wheels
- Extended Dimensions: 39-5/8" L x 15-1/2" W x 16-1/2" H
- Folded Dimensions: 25" L x 15" W x 2-3/8" H



| Model No. | Nose Plate W" x D" | Wheel Size" | Wt. lbs. |
|-----------|--------------------|-------------|----------|
| ML447 | 15-1/4 x 11 | 5 x 1-1/4 | 8.75 |

POLYETHYLENE TILT TRUCKS

POLYETHYLENE TILT TRUCKS

- Ideal for transporting and dumping waste, scrap and other bulk materials
- Polyethylene body is mounted on an all-welded steel chassis
- Includes small swivel caster(s) at the front and large fixed wheels at the rear



MN980



MN981



MN982



MN983

| Model No. | Durability | Overall Dimensions L" x W" x H" | Capacity Cu.yd. | Capacity lbs. | Front Wheel Type | Rear Wheel Type |
|-----------|---------------|------------------------------------|--------------------|------------------|---------------------|-----------------------|
| MN980 | Light Duty | 57 x 28 x 38 | 5/8 | 500 | 8" Mold-On Rubber | 4" Non-Marking Rubber |
| MN981 | Standard Duty | 57 x 28 x 38 | 5/8 | 850 | 10" Mold-On Rubber | 5" Non-Marking Rubber |
| MN982 | Standard Duty | 66 x 34 x 43 | 1.1 | 1250 | 12" Mold-On Rubber | 5" Non-Marking Rubber |
| MN983 | Heavy Duty | 66 x 34 x 43 | 1.1 | 2000 | 12" Mold-On Rubber | 5" Non-Marking Rubber |

REPLACEMENT PARTS FOR MN982 AND MN983

Model No. **ML846**, 5" Mold-on Rubber Swivel Caster
 Model No. **MN693**, 12" Mold-on Rubber Wheel

REPLACEMENT PARTS FOR MN981 AND MN982

Model No. **ML337**, 5" Non-Marking Rubber Swivel Caster
 Model No. **MN694**, 10" Mold-on Rubber Wheel

BOX TRUCKS & SELF DUMPING HOPPERS

MN985



MN984

HEAVY-DUTY POLYETHYLENE BOX TRUCKS

- Seamless durable 100% polyethylene bins
- Leakproof and easy to clean
- Available with 3/4" treated plywood undercarriage or all-welded steel chassis with a durable KLETON blue enamel finish
- Includes 2 swivel and 2 rigid casters
- Capacity is based on evenly distributed weight
- Stackable for storage
- Caster type: 3" Polyolefin
- Bin colour: Black
- Bin material: Polyethylene
- Caster placement: Corner standard
- Tapered walls

| Model No. | Base | Capacity | Capacity | Overall Dimensions L" x W" x H" |
|-----------|---------------|----------|----------|------------------------------------|
| | | Cu. ft. | lbs. | |
| MN984 | Plywood | 9 | 500 | 37 x 26 x 30 |
| MN985 | Steel Chassis | 9 | 800 | 37 x 26 x 30 |
| MN986 | Plywood | 12 | 500 | 39 x 27 x 30 |
| MN987 | Steel Chassis | 12 | 800 | 39 x 27 x 30 |
| MN988 | Plywood | 16 | 500 | 43 x 30 x 33 |
| MN989 | Steel Chassis | 16 | 800 | 43 x 30 x 33 |

REPLACEMENT PARTS

Model No. **ML391**, 3" Swivel Polyolefin Caster



SELF-DUMPING HOPPER

- Safety chain to secure to fork lift
- Positive action release lever/latch prevents unwanted dumping
- Material: Polyethylene
- Colour: Grey
- Fork Pocket Size: 3"H x 7.5"W

| Model No. | Capacity | Size |
|-----------|----------|-----------------|
| | cu. yd. | L" x W" x H" |
| MP155 | 5/8 | 62" x 31" x 42" |
| MP156 | 1-1/10 | 72" x 37" x 47" |



MP155

HEAVY-DUTY WHITE WALL POLY BOX TRUCKS

- Seamless durable 100% polyethylene bins
- Leakproof and easy to clean
- Available with 3/4" treated plywood undercarriage or all-welded steel chassis with a durable KLETON blue enamel finish
- Includes 2 swivel and 2 rigid casters
- Capacity is based on evenly distributed weight
- Caster type: 4" non-marking blue rubber
- Bin colour: White
- Bin material: White polyethylene
- Caster placement: Corner standard

| Model No. | Base | Capacity cu. ft. | Capacity lbs. | Overall Dimensions L" x W" x H" |
|---------------------|---------------|------------------|---------------|---------------------------------|
| TAPERED WALL | | | | |
| MN990* | Plywood | 7 | 600 | 33 x 20 x 29 |
| MN991* | Steel Chassis | 7 | 1000 | 33 x 20 x 29 |
| MN992* | Plywood | 9 | 600 | 37 x 26 x 31 |
| MN993* | Steel Chassis | 9 | 1000 | 37 x 26 x 31 |
| MN994* | Plywood | 12 | 600 | 39 x 27 x 31 |
| MN995* | Steel Chassis | 12 | 1000 | 39 x 27 x 31 |
| MN998* | Plywood | 16 | 600 | 43 x 30 x 34 |
| MN999* | Steel Chassis | 16 | 1000 | 43 x 30 x 34 |

STRAIGHT WALL

| | | | | |
|-------|---------------|----|------|--------------|
| MN996 | Plywood | 14 | 600 | 46 x 28 x 31 |
| MN997 | Steel Chassis | 14 | 1000 | 46 x 28 x 31 |
| M0001 | Plywood | 22 | 600 | 57 x 34 x 33 |
| M0002 | Steel Chassis | 22 | 1000 | 57 x 34 x 33 |
| M0003 | Plywood | 25 | 600 | 51 x 33 x 39 |
| M0004 | Steel Chassis | 25 | 1000 | 51 x 33 x 39 |

*Stackable for storage

REPLACEMENT CASTERS FOR TAPERED WALL TRUCKS

| Model No | Description |
|----------|-------------------------------------|
| ML334 | 4" Rigid Non-Marking Rubber Caster |
| ML333 | 4" Swivel Non-Marking Rubber Caster |

REPLACEMENT CASTERS FOR STRAIGHT WALL TRUCKS

| Model No. | Swivel Type | Caster Type |
|-----------|-------------|-----------------------|
| ML334 | Rigid | 4" Non-Marking Rubber |
| ML333 | Swivel | 4" Non-Marking Rubber |
| ML338 | Rigid | 5" Non-Marking Rubber |
| ML337 | Swivel | 5" Non-Marking Rubber |
| MN445 | Rigid | 5" Sandwich |
| MN444 | Swivel | 5" Sandwich |
| ML862 | Rigid | 6" Hi-Temp Nylon |
| ML861 | Swivel | 6" Hi-Temp Nylon |



MN992



MN995

Please see pages
114-117 to determine
which caster best suits
your specific needs.



MN996



Customize KLETON products to your specs!
See Inside Front Cover

POLY BOX TRUCKS & MESH STOCK TRUCKS

EASY ACCESS POLY BOX TRUCK

- Drop-style side wall allows for easy loading and unloading
- Volume Capacity: 22 cu. ft.
- Weight Capacity: 1000 lbs.
- Bin Material: Polyethylene
- Caster Placement: Corner Standard
- Caster Type: 4" Non-Marking Blue Rubber
- Bin Colour: Grey
- Base Type: Plywood

MP036



| Model No | Volume Capacity | Dimensions L" x W" x H" | Caster Size |
|----------|-----------------|--------------------------|----------------------------|
| MP035 | 22 cu. ft. | 45-3/4 x 31-1/4 x 37-3/4 | 4" Non-Marking Blue Rubber |
| MP036 | 24 cu. ft. | 63 x 34-1/4 x 38-1/2 | 5" Non-Marking Blue Rubber |

WIRE MESH STOCK TRUCK

- Rugged all-welded steel construction, ready to use
- Designed for efficient loading/unloading and transportation of merchandise
- Frame constructed from 1-1/2" angle iron and 2" x 2" wire mesh
- Includes: Two rigid and two swivel 5" or 6" bolted-on casters
- Durable KLETON blue enamel finish
- Capacity is based on evenly distributed weight

M0060



M0045



WITHOUT DROP GATE

| Model No | Caster Diameter | Caster Material | Dimensions W" x H" x D" | Capacity |
|----------|-----------------|-----------------|-------------------------|-----------|
| M0044 | 5" | Rubber | 24 x 55 x 36 | 1200 lbs. |
| M0046 | 6" | Polyurethane | 24 x 55 x 36 | 2400 lbs. |
| M0048 | 5" | Rubber | 24 x 55 x 48 | 1200 lbs. |
| M0050 | 6" | Polyurethane | 24 x 55 x 48 | 2400 lbs. |
| M0052 | 5" | Rubber | 24 x 55 x 60 | 1200 lbs. |
| M0054 | 6" | Polyurethane | 24 x 55 x 60 | 2400 lbs. |
| M0056 | 5" | Rubber | 30 x 55 x 48 | 1200 lbs. |
| M0058 | 6" | Polyurethane | 30 x 55 x 48 | 2400 lbs. |
| M0060 | 5" | Rubber | 30 x 55 x 60 | 1200 lbs. |
| M0062 | 6" | Polyurethane | 30 x 55 x 60 | 2400 lbs. |
| M0064 | 5" | Rubber | 30 x 55 x 72 | 1200 lbs. |
| M0066 | 6" | Polyurethane | 30 x 55 x 72 | 2400 lbs. |

WITH DROP GATE

| Model No | Caster Diameter | Caster Material | Dimensions W" x H" x D" | Capacity |
|----------|-----------------|-----------------|-------------------------|-----------|
| M0045 | 5" | Rubber | 24 x 55 x 36 | 1200 lbs. |
| M0047 | 6" | Polyurethane | 24 x 55 x 36 | 2400 lbs. |
| M0049 | 5" | Rubber | 24 x 55 x 48 | 1200 lbs. |
| M0051 | 6" | Polyurethane | 24 x 55 x 48 | 2400 lbs. |
| M0053 | 5" | Rubber | 24 x 55 x 60 | 1200 lbs. |
| M0055 | 6" | Polyurethane | 24 x 55 x 60 | 2400 lbs. |
| M0057 | 5" | Rubber | 30 x 55 x 48 | 1200 lbs. |
| M0059 | 6" | Polyurethane | 30 x 55 x 48 | 2400 lbs. |
| M0061 | 5" | Rubber | 30 x 55 x 60 | 1200 lbs. |
| M0063 | 6" | Polyurethane | 30 x 55 x 60 | 2400 lbs. |
| M0065 | 5" | Rubber | 30 x 55 x 72 | 1200 lbs. |
| M0067 | 6" | Polyurethane | 30 x 55 x 72 | 2400 lbs. |

MESH STOCK TRUCKS

- Rugged all-welded steel construction, ready to use
- Designed for efficient loading/unloading and transportation of merchandise



ML163



TWO-SIDED WIRE MESH SHELF TRUCKS

- 14-gauge steel shelves, 1-1/2" lip up
- Frame constructed from 1-1/2" angle iron and 2" x 2" wire mesh
- Includes: Two rigid and two swivel 5" or 6" bolted-on casters
- Durable KLETON blue enamel finish
- Handle Height: 42"

1200 - 2400 LB. CAPACITY
Evenly Distributed

2 SHELVES

| 5" Non-Marking Rubber Casters 1200-lb. Cap. Model No. | 6" Polyurethane Casters 2400-lb. Cap. Model No. | Base W" x L" | Inside Wall Height" | Clearance Between Shelves | Overall Dimensions W" x L" x H" | Wt. lbs. |
|--|--|-----------------|------------------------|------------------------------|---------------------------------------|-------------|
| ML162 | ML168 | 24 x 36 | 55 | 26 | 24 x 39 x 63 | 95 |
| ML163 | ML169 | 24 x 48 | 55 | 26 | 24 x 51 x 63 | 112 |
| ML164 | ML170 | 24 x 60 | 55 | 26 | 24 x 63 x 63 | 127 |
| ML165 | ML171 | 30 x 48 | 55 | 26 | 30 x 51 x 63 | 129 |
| ML166 | ML172 | 30 x 60 | 55 | 26 | 30 x 63 x 63 | 144 |
| ML167 | ML173 | 30 x 72 | 55 | 26 | 30 x 75 x 63 | 167 |

ML175



3 SHELVES

| 5" Non-Marking Rubber Casters 1200-lb. Cap. Model No. | 6" Polyurethane Casters 2400-lb. Cap. Model No. | Base W" x L" | Inside Wall Height" | Clearance Between Shelves" | Overall Dimensions W" x L" x H" | Wt. lbs. |
|--|--|-----------------|------------------------|-------------------------------|---------------------------------------|-------------|
| ML174 | ML180 | 24 x 36 | 55 | 16-1/2 | 24 x 39 x 63 | 120 |
| ML175 | ML181 | 24 x 48 | 55 | 16-1/2 | 24 x 51 x 63 | 137 |
| ML176 | ML182 | 24 x 60 | 55 | 16-1/2 | 24 x 63 x 63 | 152 |
| ML177 | ML183 | 30 x 48 | 55 | 16-1/2 | 30 x 51 x 63 | 154 |
| ML178 | ML184 | 30 x 60 | 55 | 16-1/2 | 30 x 63 x 63 | 169 |
| ML179 | ML185 | 30 x 72 | 55 | 16-1/2 | 30 x 75 x 63 | 192 |

REPLACEMENT PARTS

- Model No. **ML338**, 5" Rigid Non-Marking Rubber Caster
- Model No. **ML337**, 5" Swivel Non-Marking Rubber Caster
- Model No. **ML400**, 6" Rigid Polyurethane Caster
- Model No. **ML399**, 6" Swivel Polyurethane Caster

BOX TRUCKS

- Rugged all-welded 1-1/2" angle iron construction and 2" x 2" wire mesh
- Contains and transports small bulk parts or materials in your plant or warehouse
- Includes: two rigid and two swivel 5" non-marking bolted-on rubber casters
- Durable KLETON blue enamel finish

1200 - LB. CAPACITY
Evenly Distributed

MB672



| Model No. | Base W" x L" | Inside Wall Height" | Handle Height" | Overall Dimensions W" x L" x H" | Wt. lbs. |
|-----------|-----------------|------------------------|-------------------|------------------------------------|-------------|
| MB672 | 24 x 36 | 24 | 30 | 24 x 39 x 31-1/2" | 62 |
| ML186 | 24 x 48 | 24 | 30 | 24 x 51 x 31-1/2" | 75 |
| ML187 | 24 x 60 | 24 | 30 | 24 x 63 x 31-1/2" | 85 |
| ML188 | 30 x 48 | 24 | 30 | 30 x 51 x 31-1/2" | 86 |
| MB680 | 30 x 60 | 24 | 30 | 30 x 63 x 31-1/2" | 95 |
| ML189 | 30 x 72 | 24 | 30 | 30 x 75 x 31-1/2" | 107 |



- Rugged all-welded steel construction, ready to use
- Designed for efficient loading/unloading and transportation of merchandise

MESH STOCK TRUCKS

3-SIDED WIRE MESH SHELF TRUCKS

- 14-gauge steel shelves, 1-1/2" lip up
- Frame constructed from 1-1/2" angle iron and 2" x 2" wire mesh
- Includes: Two rigid and two swivel 5" or 6" bolted-on casters
- Durable KLETON blue enamel finish
- Handle Height: 42"

**1200 - 2400 LB.
CAPACITY**
Evenly Distributed

1 SHELF

| 5" Non-Marking Rubber Casters 1200-lb. Cap. Model No. | 6" Polyurethane Casters 2400-lb. Cap. Model No. | Base W" x L" | Inside Wall Height" | Overall Dimensions W" x L" x H" | Wt. lbs. |
|---|---|-----------------|------------------------|---------------------------------------|-------------|
| ML220 | ML190 | 24 x 36 | 55 | 24 x 39 x 63 | 102 |
| ML221 | ML191 | 24 x 48 | 55 | 24 x 51 x 63 | 110 |
| ML222 | ML192 | 24 x 60 | 55 | 24 x 63 x 63 | 120 |
| ML223 | ML193 | 30 x 48 | 55 | 30 x 51 x 63 | 135 |
| ML224 | ML194 | 30 x 60 | 55 | 30 x 63 x 63 | 145 |
| ML225 | ML195 | 30 x 72 | 55 | 30 x 75 x 63 | 155 |



ML221

2 SHELVES

| 5" Non-Marking Rubber Casters 1200-lb. Cap. Model No. | 6" Polyurethane Casters 2400-lb. Cap. Model No. | Base W" x L" | Inside Wall Height" | Clearance Between Shelves" | Overall Dimensions W" x L" x H" | Wt. lbs. |
|---|---|-----------------|---------------------------|----------------------------------|---------------------------------------|-------------|
| ML196 | ML202 | 24 x 36 | 55 | 26 | 24 x 39 x 63 | 127 |
| ML197 | ML203 | 24 x 48 | 55 | 26 | 24 x 51 x 63 | 142 |
| ML198 | ML204 | 24 x 60 | 55 | 26 | 24 x 63 x 63 | 159 |
| ML199 | ML205 | 30 x 48 | 55 | 26 | 30 x 51 x 63 | 182 |
| ML200 | ML206 | 30 x 60 | 55 | 26 | 30 x 63 x 63 | 192 |
| ML201 | ML207 | 30 x 72 | 55 | 26 | 30 x 75 x 63 | 211 |



ML200

3 SHELVES

| 5" Non-Marking Rubber Casters 1200-lb. Cap. Model No. | 6" Polyurethane Casters 2400-lb. Cap. Model No. | Base W" x L" | Inside Wall Height" | Clearance Between Shelves" | Overall Dimensions W" x L" x H" | Wt. lbs. |
|---|---|-----------------|---------------------------|----------------------------------|---------------------------------------|-------------|
| ML208 | ML214 | 24 x 36 | 55 | 16-1/2 | 24 x 39 x 63 | 152 |
| ML209 | ML215 | 24 x 48 | 55 | 16-1/2 | 24 x 51 x 63 | 174 |
| ML210 | ML216 | 24 x 60 | 55 | 16-1/2 | 24 x 63 x 63 | 198 |
| ML211 | ML217 | 30 x 48 | 55 | 16-1/2 | 30 x 51 x 63 | 229 |
| ML212 | ML218 | 30 x 60 | 55 | 16-1/2 | 30 x 63 x 63 | 239 |
| ML213 | ML219 | 30 x 72 | 55 | 16-1/2 | 30 x 75 x 63 | 267 |



ML209

REPLACEMENT PARTS

- Model No. **ML338**, 5" Rigid Non-Marking Rubber Caster
 Model No. **ML337**, 5" Swivel Non-Marking Rubber Caster
 Model No. **ML400**, 6" Rigid Polyurethane Caster
 Model No. **ML399**, 6" Swivel Polyurethane Caster



ML242

- 14 gauge steel shelves, 1-1/2" lip up
- Frame constructed from 1-1/2" angle iron and 2" x 2" wire mesh
- Includes: Two rigid and two swivel 5" or 6" bolted-on casters
- Comes with hasp for padlock
- Durable KLETON blue enamel finish
- Handle height: 42"

**1200 - 2400 LB.
CAPACITY**
Evenly Distributed

2 SHELVES

| 5" Non-Marking Rubber Casters 1200-lb. Cap. Model No. | 6" Polyurethane Casters 2400-lb. Cap. Model No. | Base W" x L" | Inside Wall Height" | Clearance Between Shelves" | Overall Dimensions W" x L" x H" | Wt. lbs. |
|---|---|-----------------|---------------------------|----------------------------------|---------------------------------------|-------------|
| ML238 | ML244 | 24 x 36 | 55 | 25 | 26 x 39 x 62-1/2 | 157 |
| ML239 | ML245 | 24 x 48 | 55 | 25 | 26 x 51 x 62-1/2 | 172 |
| ML240 | ML246 | 24 x 60 | 55 | 25 | 26 x 63 x 62-1/2 | 189 |
| ML241 | ML247 | 30 x 48 | 55 | 25 | 32 x 51 x 62-1/2 | 212 |
| ML242 | ML248 | 30 x 60 | 55 | 25 | 32 x 63 x 62-1/2 | 222 |
| ML243 | ML249 | 30 x 72 | 55 | 25 | 32 x 75 x 62-1/2 | 241 |



ML254

3 SHELVES

| 5" Non-Marking Rubber Casters 1200-lb. Cap. Model No. | 6" Polyurethane Casters 2400-lb. Cap. Model No. | Base W" x L" | Inside Wall Height" | Clearance Between Shelves" | Overall Dimensions W" x L" x H" | Wt. lbs. |
|---|---|-----------------|---------------------------|----------------------------------|---------------------------------------|-------------|
| ML250 | ML256 | 24 x 36 | 55 | 16 | 26 x 39 x 62-1/2 | 182 |
| ML251 | ML257 | 24 x 48 | 55 | 16 | 26 x 51 x 62-1/2 | 204 |
| ML252 | ML258 | 24 x 60 | 55 | 16 | 26 x 63 x 62-1/2 | 228 |
| ML253 | ML259 | 30 x 48 | 55 | 16 | 32 x 51 x 62-1/2 | 259 |
| ML254 | ML260 | 30 x 60 | 55 | 16 | 32 x 63 x 62-1/2 | 269 |
| ML255 | ML261 | 30 x 72 | 55 | 16 | 32 x 75 x 62-1/2 | 297 |

REPLACEMENT PARTS

- Model No. **ML338**, 5" Rigid Non-Marking Rubber Caster
 Model No. **ML337**, 5" Swivel Non-Marking Rubber Caster
 Model No. **ML400**, 6" Rigid Polyurethane Caster
 Model No. **ML399**, 6" Swivel Polyurethane Caster

ENCLOSED WIRE STOCK PICKING CARTS

- High quality chromate shelves and posts prevent corrosion
- Enclosed sides keeps items from falling out
- Shelves can be adjusted quickly and easily
- Includes: (2) 5" swivel resilient casters, (2) 5" rubber caster with brakes
- Shipped knocked down
- One-year limited warranty
- Capacity is based on evenly distributed weight
- No. of Shelves: 4
- Strong and versatile
- Cart Material: Chrome Plated
- NSF Certified

**800 LB.
CAPACITY**
Evenly Distributed

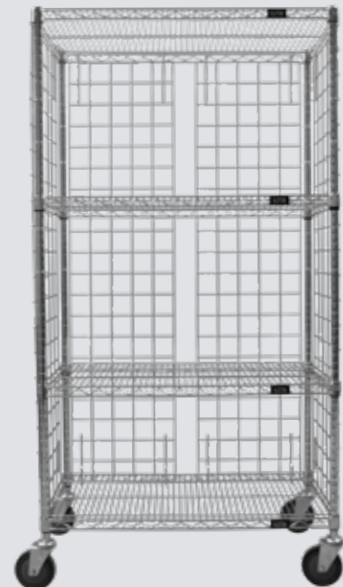

| Model No. | Overall Depth" | Overall Height" | Overall Width" |
|-----------|----------------|-----------------|----------------|
| RN559 | 18 | 69 | 36 |
| RN560 | 18 | 69 | 48 |
| RN561 | 18 | 69 | 60 |
| RN562 | 24 | 69 | 36 |
| RN563 | 24 | 69 | 48 |
| RN564 | 24 | 69 | 60 |

WIRE ENCLOSURE PANELS

| Model No. | Dimensions W" x H" |
|-----------|-----------------------|
| RN556 | 15 x 61.5 |
| RN557 | 18 x 61.5 |
| RN558 | 21 x 61.5 |



Customize KLETON products to your specs!
See Inside Front Cover

ALL-WELDED SHELF TRUCKS

1200 LB. CAPACITY
Evenly Distributed

1" round tube handle for added comfort

Two rigid and two swivel 5" non-marking double raceway casters for easy manoeuvrability with heavy loads



Double-fold 1-1/2" lip for safety and added strength configured up or down

All-welded 14-gauge steel for extra strength. Welded to 1-1/2" x 12-1/2" x 1/8" steel angle posts.

Sealed bearings for longer life

Durable KLETON blue enamel finish



ML092



MB476

| Lip Up Model No. | Lip Down Model No. | Shelf Size D" x W" | No. of Shelves | Clearance Between Shelves" | Handle Height" | Overall Dim. D" x W" x H" | Wt. lbs. |
|--|--------------------|--------------------|----------------|----------------------------|----------------|---------------------------|----------|
| 36" OVERALL HEIGHT - 14 GAUGE STEEL | | | | | | | |
| MB445 | MB444 | 30 x 18 | 2 | 27 | 36 | 33 x 18 x 36 | 60 |
| MB447 | MB446 | 36 x 24 | 2 | 27 | 36 | 39 x 24 x 36 | 65 |
| MB449 | MB448 | 48 x 24 | 2 | 27 | 36 | 51 x 24 x 36 | 100 |
| MB456 | MB455 | 30 x 18 | 3 | 12 | 36 | 33 x 18 x 36 | 75 |
| MB459 | MB458 | 36 x 24 | 3 | 12 | 36 | 39 x 24 x 36 | 85 |
| MB461 | MB460 | 48 x 24 | 3 | 12 | 36 | 51 x 24 x 36 | 110 |
| 48" OVERALL HEIGHT - 14 GAUGE STEEL | | | | | | | |
| ML084 | ML083 | 30 x 18 | 3 | 18 | 42 | 33 x 18 x 48 | 80 |
| ML086 | ML085 | 36 x 24 | 3 | 18 | 42 | 39 x 24 x 48 | 90 |
| ML088 | ML087 | 48 x 24 | 3 | 18 | 42 | 51 x 24 x 48 | 115 |
| ML090 | ML089 | 30 x 18 | 4 | 12 | 42 | 33 x 18 x 48 | 110 |
| ML092 | ML091 | 36 x 24 | 4 | 12 | 42 | 39 x 24 x 48 | 135 |
| ML094 | ML093 | 48 x 24 | 4 | 12 | 42 | 51 x 24 x 48 | 160 |
| 61" OVERALL HEIGHT - 14 GAUGE STEEL | | | | | | | |
| MB468 | MB467 | 30 x 18 | 4 | 16 | 42 | 33 x 18 x 61 | 115 |
| MB470 | MB469 | 36 x 24 | 4 | 16 | 42 | 39 x 24 x 61 | 140 |
| MB472 | MB471 | 48 x 24 | 4 | 16 | 42 | 51 x 24 x 61 | 165 |
| MB474 | MB473 | 30 x 18 | 5 | 11 | 42 | 33 x 18 x 61 | 125 |
| MB476 | MB475 | 36 x 24 | 5 | 11 | 42 | 39 x 24 x 61 | 155 |
| MB478 | MB477 | 48 x 24 | 5 | 11 | 42 | 51 x 24 x 61 | 184 |

CUSTOM OPTIONS

- Model No. **ML337**, 5" Swivel Non-Marking Rubber Caster
- Model No. **ML338**, 5" Rigid Non-Marking Rubber Caster
- Model No. **MN222**, 8" Swivel Pneumatic Caster
- Model No. **MN221**, 8" Rigid Pneumatic Caster
- Model No. **ML395**, 5" Swivel Polyolefin Caster
- Model No. **ML396**, 5" Rigid Polyolefin Caster
- Model No. **MC043**, Corner Bumper



MC043



ML337



ML338



MN222



MN221



ML395



ML396

KNOCKED-DOWN SHELF TRUCKS

Customize KLETON products to your specs!
See Inside Front Cover



CHOOSE FROM 3 CASTER TYPES



5" POLYOLEFIN



5" BLUE ELASTIC RUBBER



8" PNEUMATIC



900 - LB. CAPACITY
Evenly Distributed

- Seamed fold for smooth edges
- Durable KLETON blue enamel finish
- Top and middle shelves can be installed lip up or down
- Slotted caster holes to allow virtually any caster to be installed



- 1-1/4" diameter tubular steel, one piece handle for added comfort
- 16-gauge steel shelves with 2-1/2" high lip
- 1-1/2" x 1-1/2" 12-gauge steel posts with pre-punched holes for added strength
- 2 rigid and 2 swivel bolted-on casters



MB489



MB496

2 SHELF UTILITY TRUCKS

| Model No. | Shelf Dimensions D" x W" | Shelf Clearance" | Post Height" | Overall Dim D" x W" x H" | Weight lbs. |
|---------------------------------------|--------------------------|------------------|--------------|--------------------------|-------------|
| 5" POLYOLEFIN CASTERS | | | | | |
| MB482 | 30 x 18 | 25 | 30 | 33 x 18 x 36 | 48 |
| MB483 | 36 x 24 | 25 | 30 | 39 x 24 x 36 | 63 |
| MB484 | 48 x 24 | 25 | 30 | 51 x 24 x 36 | 74 |
| 5" BLUE ELASTIC RUBBER CASTERS | | | | | |
| MB492 | 30 x 18 | 25 | 30 | 33 x 18 x 36 | 52 |
| MB493 | 36 x 24 | 25 | 30 | 39 x 24 x 36 | 67 |
| MB494 | 48 x 24 | 25 | 30 | 51 x 24 x 36 | 78 |
| 8" PNEUMATIC CASTERS | | | | | |
| MB488 | 36 x 24 | 25 | 30 | 39 x 24 x 40 | 80 |
| MB489 | 48 x 24 | 25 | 30 | 51 x 24 x 40 | 91 |

3 SHELF UTILITY TRUCKS

| Model No. | Shelf Dimensions D" x W" | Shelf Clearance" | Post Height" | Overall Dim D" x W" x H" | Weight lbs. |
|---------------------------------------|--------------------------|------------------|--------------|--------------------------|-------------|
| 5" POLYOLEFIN CASTERS | | | | | |
| MB485 | 30 x 18 | 11 | 30 | 33 x 18 x 36 | 63 |
| MB486 | 36 x 24 | 11 | 30 | 39 x 24 x 36 | 86 |
| MB487 | 48 x 24 | 11 | 30 | 51 x 24 x 36 | 103 |
| MN143 | 30 x 18 | 17 | 42 | 33 x 18 x 48 | 69 |
| MN144 | 36 x 24 | 17 | 42 | 39 x 24 x 48 | 92 |
| MN145 | 48 x 24 | 17 | 42 | 51 x 24 x 48 | 109 |
| 5" BLUE ELASTIC RUBBER CASTERS | | | | | |
| MB495 | 30 x 18 | 11 | 30 | 33 x 18 x 36 | 67 |
| MB496 | 36 x 24 | 11 | 30 | 39 x 24 x 36 | 89 |
| MB497 | 48 x 24 | 11 | 30 | 51 x 24 x 36 | 106 |
| ML142 | 30 x 18 | 17 | 42 | 33 x 18 x 48 | 73 |
| ML143 | 37 x 24 | 17 | 42 | 39 x 24 x 48 | 95 |
| ML144 | 48 x 24 | 17 | 42 | 51 x 24 x 48 | 112 |
| 8" PNEUMATIC CASTERS | | | | | |
| MB490 | 36 x 24 | 11 | 30 | 39 x 24 x 40 | 102 |
| MB491 | 48 x 24 | 11 | 30 | 51 x 24 x 40 | 119 |
| MN146 | 36 x 24 | 17 | 42 | 39 x 24 x 52 | 108 |
| MN147 | 48 x 24 | 17 | 42 | 51 x 24 x 52 | 102 |



Customize KLETON products to your specs!
See Inside Front Cover

KNOCKED-DOWN SHELF TRUCKS

4 SHELF UTILITY TRUCKS

| Model No. | Shelf Dimensions D" x W" | Shelf Clearance" | Post Height" | Overall Dim D" x W" x H" | Weight lbs. |
|---------------------------------------|--------------------------|------------------|--------------|--------------------------|-------------|
| 5" POLYOLEFIN CASTERS | | | | | |
| MN148 | 30 x 18 | 10 | 42 | 33 x 18 x 48 | 84 |
| MN149 | 36 x 24 | 10 | 42 | 39 x 24 x 48 | 114 |
| MN150 | 48 x 24 | 10 | 42 | 51 x 24 x 48 | 137 |
| MN151 | 30 x 18 | 15 | 55 | 33 x 18 x 61 | 89 |
| MN152 | 36 x 24 | 15 | 55 | 39 x 24 x 61 | 120 |
| MN153 | 48 x 24 | 15 | 55 | 51 x 24 x 61 | 143 |
| 5" BLUE ELASTIC RUBBER CASTERS | | | | | |
| ML145 | 30 x 18 | 10 | 42 | 33 x 18 x 48 | 87 |
| ML146 | 36 x 24 | 10 | 42 | 39 x 24 x 48 | 117 |
| ML147 | 48 x 24 | 10 | 42 | 51 x 24 x 48 | 140 |
| ML148 | 30 x 18 | 15 | 55 | 33 x 18 x 61 | 93 |
| ML149 | 36 x 24 | 15 | 55 | 39 x 24 x 61 | 123 |
| ML150 | 48 x 24 | 15 | 55 | 51 x 24 x 61 | 146 |
| 8" PNEUMATIC CASTERS | | | | | |
| MN154 | 36 x 24 | 10 | 42 | 24 x 39 x 52 | 130 |
| MN155 | 48 x 24 | 10 | 42 | 24 x 51 x 52 | 154 |
| MN156 | 36 x 24 | 15 | 55 | 24 x 39 x 65 | 136 |
| MN157 | 48 x 24 | 15 | 55 | 24 x 51 x 65 | 159 |



ML146

5 SHELF UTILITY TRUCKS

| Model No. | Shelf Dimensions D" x W" | Shelf Clearance" | Post Height" | Overall Dim D" x W" x H" | Weight lbs. |
|---------------------------------------|--------------------------|------------------|--------------|--------------------------|-------------|
| 5" POLYOLEFIN CASTERS | | | | | |
| MN158 | 30 x 18 | 10 | 55 | 33 x 18 x 61 | 104 |
| MN159 | 36 x 24 | 10 | 55 | 39 x 24 x 61 | 142 |
| MN160 | 48 x 24 | 10 | 55 | 51 x 24 x 61 | 171 |
| 5" BLUE ELASTIC RUBBER CASTERS | | | | | |
| ML151 | 30 x 18 | 10 | 55 | 33 x 18 x 61 | 107 |
| ML152 | 36 x 24 | 10 | 55 | 39 x 24 x 61 | 145 |
| ML153 | 48 x 24 | 10 | 55 | 51 x 24 x 61 | 175 |
| 8" PNEUMATIC CASTERS | | | | | |
| MN161 | 36 x 24 | 10 | 55 | 39 x 24 x 65 | 158 |
| MN162 | 48 x 24 | 10 | 55 | 51 x 24 x 65 | 188 |



ML152

CUSTOM OPTIONS

- Model No. **ML337**, 5" Swivel Non-Marking Rubber Caster
- Model No. **ML338**, 5" Rigid Non-Marking Rubber Caster
- Model No. **MN222**, 8" Swivel Pneumatic Caster
- Model No. **MN221**, 8" Rigid Pneumatic Caster
- Model No. **ML395**, 5" Swivel Polyolefin Caster
- Model No. **ML396**, 5" Rigid Polyolefin Caster
- Model No. **MC043**, Corner Bumper



MC043



ML337



ML338



MN222



MN221



ML395



ML396

LOW PROFILE SHELF TRUCKS

- All-welded cart with low shelf means less distance to lift heavy object
- Two 14-gauge steel shelves with a 1-1/2" lip down
- 1-1/4" diameter tubular steel handle
- 2 rigid and 2 swivel bolted-on casters
- Durable KLETON blue enamel finish





1200 - LB. CAPACITY
Evenly Distributed

MB425

HEAVY-DUTY LOW PROFILE SHOP TRUCKS

5" RUBBER CASTERS

- Non-marking 5" rubber casters are quiet rolling and ideal for both institutional and industrial applications
- Casters are resistant to wet and corrosive chemical conditions

| Model No. | Shelf Size" | Clearance Between Shelves" | Handle Height" | Top Shelf Height" | Overall Dimensions W" x L" x H" | Wt. lbs. |
|-----------|-------------|----------------------------|----------------|-------------------|---------------------------------|----------|
| MB421 | 18 x 30 | 16 | 40 | 26 | 18 x 34 x 40 | 90 |
| MB425 | 24 x 36 | 16 | 40 | 26 | 24 x 40 x 40 | 110 |
| MB429 | 24 x 48 | 16 | 40 | 26 | 24 x 52 x 40 | 125 |
| ML097 | 24 x 60 | 16 | 40 | 26 | 24 x 64 x 40 | 155 |
| ML098 | 30 x 48 | 16 | 40 | 26 | 30 x 52 x 40 | 155 |
| MB434 | 30 x 60 | 16 | 40 | 26 | 30 x 64 x 40 | 165 |
| ML099 | 30 x 72 | 16 | 40 | 26 | 30 x 76 x 40 | 175 |

REPLACEMENT PARTS

Model No. **ML338**, 5" Rigid Non-Marking Rubber Caster
 Model No. **ML337**, 5" Swivel Non-Marking Rubber Caster
 Model No. **MC043**, Corner Bumpers



2400 - LB. CAPACITY
Evenly Distributed

MB426

HEAVY-DUTY LOW PROFILE SHOP TRUCKS

6" HIGH TEMP OR POLYURETHAN CASTERS

- Solid black 6" high-temp nylon casters handle heavy loads easily
- Solid 6" polyurethane casters are non-marking and are highly resistant to wear
- Best choice in uneven floor applications
- Handle height: 41"

6" HIGH-TEMP NYLON CASTERS

| Model No. | Shelf Size" | Clearance Between Shelves" | Top Shelf Height" | Overall Dim. W" x L" x H" | Wt. lbs. |
|-----------|-------------|----------------------------|-------------------|---------------------------|----------|
| MB422 | 18 x 30 | 16 | 27 | 18 x 34 x 41 | 100 |
| MB426 | 24 x 36 | 16 | 27 | 24 x 40 x 41 | 130 |
| MB430 | 24 x 48 | 16 | 27 | 24 x 52 x 41 | 145 |
| ML100 | 24 x 60 | 16 | 27 | 24 x 64 x 41 | 155 |
| ML101 | 30 x 48 | 16 | 27 | 30 x 52 x 41 | 155 |
| MB435 | 30 x 60 | 16 | 27 | 30 x 64 x 41 | 165 |
| ML102 | 30 x 72 | 16 | 27 | 30 x 76 x 41 | 175 |

6" POLYURETHANE CASTERS

| Model No. | Shelf Size" | Clearance Between Shelves" | Top Shelf Height" | Overall Dim. W" x L" x H" | Wt. lbs. |
|-----------|-------------|----------------------------|-------------------|---------------------------|----------|
| ML103 | 18 x 30 | 16 | 27 | 18 x 34 x 41 | 100 |
| ML104 | 24 x 36 | 16 | 27 | 24 x 40 x 41 | 130 |
| ML105 | 24 x 48 | 16 | 27 | 24 x 52 x 41 | 145 |
| ML106 | 24 x 60 | 16 | 27 | 24 x 64 x 41 | 155 |
| ML107 | 30 x 48 | 16 | 27 | 30 x 52 x 41 | 155 |
| ML108 | 30 x 60 | 16 | 27 | 30 x 64 x 41 | 165 |
| ML109 | 30 x 72 | 16 | 27 | 30 x 76 x 41 | 175 |

REPLACEMENT PARTS

Model No. **ML400**, 6" Rigid Polyurethane Caster
 Model No. **ML399**, 6" Swivel Polyurethane Caster
 Model No. **ML862**, 6" Rigid Hi-Temp Nylon Caster
 Model No. **ML861**, 6" Swivel Hi-Temp Nylon Caster
 Model No. **MC043**, Corner Bumpers



Customize KLETON products to your specs!
See Inside Front Cover

SHELF TRUCKS & STOCK PICKING TRUCKS

SHELF/PLATFORM TRUCKS

- An efficient 2-in-1 shelf and platform truck design
- Features 2 front corner bumpers and a removable 11-gauge top shelf to convert to a platform truck
- 2 rigid and 2 swivel bolted-on 5" non-marking rubber casters
- Top shelf capacity: 500 lbs. evenly distributed
- Bottom shelf capacity: 800 lbs. evenly distributed
- Durable KLETON blue enamel finish

1300 - LB. CAPACITY
Evenly Distributed



MB391

| Model No. | Shelf Size" | Top Shelf Height" | Shelf Clearance" | Handle Height" | Overall Dim. W" x L" x H" | Wt. lbs. |
|-----------|-------------|-------------------|------------------|----------------|---------------------------|----------|
| MB391 | 24 x 36 | 32 | 24 | 40 | 26 x 38 x 40 | 105 |

REPLACEMENT PARTS

Model No. **ML338**, 5" Rigid Non-Marking Rubber Caster
Model No. **ML337**, 5" Swivel Non-Marking Rubber Caster
Model No. **MC043**, Corner Bumpers

STOCK PICKING TRUCKS

- Pick and transport stock without the need for a separate ladder
- Slip-resistant 22" W x 4" D steps and positive locking engagement for safety
- 14-gauge steel shelves with 1-1/2" lip, configured up
- 1-1/2" x 1-1/2" x 1/8" steel angle posts
- 2 rigid and 2 swivel bolted-on non-marking rubber casters

1200 - LB. CAPACITY
Evenly Distributed



MB507

| Model No. | Shelf Size" | Number of Shelves | Clearance Between Shelves" | Number of Steps | Step Rise" | Overall Dimensions W" x L" x H" | Wt. lbs. |
|-----------|-------------|-------------------|----------------------------|-----------------|------------|---------------------------------|----------|
| MD441 | 24 x 36 | 3 | 12 | 3 | 9-1/2 | 24 x 52 x 61 | 135 |
| MB507 | 24 x 48 | 3 | 12 | 3 | 9-1/2 | 24 x 64 x 61 | 140 |
| MD442 | 24 x 36 | 3 | 12 | 5 | 9-1/2 | 24 x 52 x 78 | 145 |
| MB508 | 24 x 48 | 3 | 12 | 5 | 9-1/2 | 24 x 64 x 78 | 150 |

ORDER PICKING TRUCKS

- Picking list holder eliminates the need to handle loose papers
- 14-gauge steel shelves with 1-1/2" lip, configured up
- 1-1/2" x 1-1/2" x 1/8" steel angle posts
- 2 rigid and 2 swivel bolted 5" non-marking rubber casters

1200 - LB. CAPACITY
Evenly Distributed



MB442

| Model No. | Shelf Size" | Number of Shelves | Clearance Between Shelves" | Handle Height" | Overall Dimensions W" x L" x H" | Wt. lbs. |
|-----------|-------------|-------------------|----------------------------|----------------|---------------------------------|----------|
| MB440 | 18 x 30 | 2 | 27 | 36 | 18 x 46 x 36 | 70 |
| MB441 | 24 x 36 | 2 | 27 | 36 | 24 x 52 x 36 | 80 |
| ML095 | 24 x 48 | 2 | 27 | 36 | 24 x 64 x 36 | 110 |
| MB442 | 18 x 30 | 3 | 12 | 36 | 18 x 46 x 36 | 85 |
| MB443 | 24 x 36 | 3 | 12 | 36 | 24 x 52 x 36 | 100 |
| ML096 | 24 x 48 | 3 | 12 | 36 | 24 x 64 x 36 | 120 |

**1200 - LB.
CAPACITY**
Evenly Distributed



MH255

HEAVY-DUTY SHELF TRUCKS WITH DRAWER

- Cart constructed from 14-gauge steel shelves welded to 1-1/2" x 1-1/2" x 1/8" steel angle posts
- 36" high, 1" diameter tubular steel handle
- Drawer dimensions: 15 1/4" W x 20" L x 6" H, 100-lb. capacity
- Available in models with 2 or 3 shelves with 1-1/2" lip configured up
- 2 rigid and 2 swivel bolted-on 5" non-marking casters

| Model No. | Shelf Size" | No. Shelves | Clearance Between Shelves" | Drawer to Shelf Clearance" | Overall Dimensions W" x L" x H" | Wt. lbs. |
|-----------|-------------|-------------|----------------------------|----------------------------|---------------------------------|----------|
| MH255 | 24 x 36 | 2 | 27 | 18 | 24 x 39 x 36 | 75 |
| MH256 | 24 x 36 | 3 | 12 | 3 | 24 x 39 x 36 | 95 |
| ML081 | 24 x 48 | 2 | 27 | 18 | 24 x 51 x 36 | 110 |
| ML082 | 24 x 48 | 3 | 12 | 3 | 24 x 51 x 36 | 120 |

REPLACEMENT PARTS

- Model No. **ML338**, 5" Rigid Non-Marking Rubber Caster
 Model No. **ML337**, 5" Swivel Non-Marking Rubber Caster
 Model No. **MC043**, Corner Bumpers

MOBILE SERVICE TRUCK

- Louvered panel for small parts bins and lockable drawer for supplies
- Two 14-gauge steel shelves welded to 1-1/2" x 1-1/2" x 1/8" steel posts
- 36" high, 1" diameter tubular handle
- 2 rigid and 2 swivel with brake bolted-on 5" non-marking rubber casters

**1200 - LB.
CAPACITY**
Evenly Distributed



| Model No. | Shelf Size" | No. Shelves | Clearance Between Shelves" | Drawer to Shelf Clearance" | Overall Dimensions W" x L" x H" | Wt. lbs. |
|-----------|-------------|-------------|----------------------------|----------------------------|---------------------------------|----------|
| MN396 | 24 x 36 | 2 | 27 | 18 | 24 x 40 x 57 | 88 |

MOBILE SERVICE CARTS

- All welded design, ready to use
- Two 14 gauge steel shelves welded to 1 1/2" x 1 1/2" x 1/8" steel posts 1" diameter tubular handle
- Two rigid and two swivel with brake bolted-on 5" non-marking rubber casters
- Durable KLETON blue enamel finish
- Clearance Between Shelves: 27"
- Drawer to Shelf Clearance: 18"

**1200 - LB.
CAPACITY**
Evenly Distributed



| Model No. | No. Shelves | Overall Dimensions W" x L" x H" | Description |
|-----------|-------------|---------------------------------|-------------------|
| MP084 | 2 | 24 x 40 x 57 | Pegboard |
| MP085 | 2 | 24 x 40 x 57 | Louvered/Pegboard |



Customize KLETON products to your specs!
See Inside Front Cover

ERGONOMIC SHELF & PLATFORM TRUCKS

DEEP LIPPED SERVICE TRUCKS

- All welded design, ready to use
- Deep shelf lips for retention
- Two 14 gauge steel shelves welded to 1-1/2" x 1-1/2" x 1/8" steel posts
- 1" diameter tubular ergonomic handle
- Two rigid and two swivel 5" non-marking rubber casters
- Durable KLETON blue enamel finish

1200 - LB. CAPACITY
Evenly Distributed

MN395



| Model No. | Shelf Size D" x W" | Shelf Lip Depth | Clearance Between Shelves " | Overall Dimensions D" x W" x H" | Wt. lbs. |
|-----------|--------------------|-----------------------|-----------------------------|---------------------------------|----------|
| MN393 | 36 x 24 | Top 6"/Bottom 1-1/2" | 22-1/2 | 42 x 24 x 47 | 85 |
| MN394 | 36 x 24 | Top 12"/Bottom 1-1/2" | 16 | 42 x 24 x 47 | 90 |
| MN395 | 36 x 24 | Top 6"/Bottom 6" | 18 | 42 x 24 x 47 | 90 |

ERGONOMIC SHELF TRUCKS

- All-welded 16-gauge construction
- All-welded ergonomic handle placed at a comfortable working height
- Two rigid and two swivel 5" casters
- Durable KLETON blue enamel finish



800 - LB. CAPACITY
Evenly Distributed

| Model No. | Number of Shelves | Caster Type | Overall Dimensions D" x W" x H" | Wt. lbs. |
|-----------|-------------------|-------------|---------------------------------|----------|
| ML561 | 2 | Blue Rubber | 32 x 20 x 37 | 53 |
| MN056 | 2 | Blue Rubber | 38 x 26 x 37 | 67 |
| ML562 | 3 | Blue Rubber | 32 x 20 x 37 | 65 |
| MN055 | 3 | Blue Rubber | 38 x 26 x 37 | 93 |
| ML563 | 2 | Polyolefin | 32 x 20 x 37 | 49 |
| ML883 | 2 | Polyolefin | 38 x 26 x 37 | 63 |
| ML564 | 3 | Polyolefin | 32 x 20 x 37 | 61 |
| ML884 | 3 | Polyolefin | 38 x 26 x 37 | 89 |

REPLACEMENT PARTS

- Model No. **ML338**, 5" Rigid Non-Marking Rubber Caster
- Model No. **ML337**, 5" Swivel Non-Marking Rubber Caster
- Model No. **ML396**, 5" Rigid Polyolefin Caster
- Model No. **ML395**, 5" Swivel Polyolefin Caster

ERGONOMIC PLATFORM TRUCK

- Ergonomic handle is placed at a comfortable working height to alleviate back strains
- Picking list holder eliminates the need to handle loose papers
- Deck is constructed from 14-gauge all welded steel with a turned down lip and reinforced channels
- Two rigid and two swivel casters 8" mold-on rubber casters
- Dimensions: 48"L x 24"W
- Weight: 90 lbs.
- KLETON powder coat finish

Model No. **ML892**

1200 - LB. CAPACITY
Evenly Distributed



REPLACEMENT PARTS

- Model No. **ML853**, 8" Rigid Mold-On Rubber
- Model No. **ML852**, 8" Swivel Mold-On Rubber

PLASTIC SHELF TRUCKS & PLATFORM TRUCKS

PLASTIC UTILITY SERVICE TRUCKS

- Durable structural foam construction will not dent, rust or bend
- Non-marking 5" casters
- Overall dimensions: 17-1/2" W x 34-1/2" D x 32-1/2" H

Model No. **ML618**

- Durable structural foam construction will not dent, rust or bend
- Non-marking 5" casters
- Overall dimensions: 25-1/2" W x 40-1/2" D x 32-1/2" H

Model No. **ML619**

**500-LB.
CAPACITY**
Evenly Distributed



ML618



ML619

PLASTIC FLAT SHELF UTILITY TRUCKS

- Durable structural foam construction will not dent, rust or bend
- Non-marking 5" casters
- Flat top shelf makes loading and unloading of heavy boxes easy
- Overall dimensions: 25-1/2" W x 40-1/2" D x 32-1/2" H
- Capacity: 500 lbs.

Model No. **ML620**



ML620

REPLACEMENT PARTS - COMPATIBLE WITH THREE MODELS ABOVE

- Model No. **M0730**, 5" Rigid Non-marking Rubber Caster
 Model No. **M0731**, 5" Swivel Non-marking Rubber Caster

PLASTIC PLATFORM TRUCKS

- HDPE-molded structural plastic for strength and long-term durability
- Lightweight, easy to clean, chemical resistant, and resists damage from long-term exposure to weather conditions
- Non-skid deck surface
- Removable steel handle
- Other caster options and capacities available upon request

**900 - 2500 - LB.
CAPACITY**
Evenly Distributed



MN428

| Model No. | Caster Type | Platform Size W" x L" | Deck Height" | Handle Height" | Cap. lbs. | Wt. lbs. |
|-----------|-------------------|-----------------------|--------------|----------------|-----------|----------|
| MN428 | 8" Mold-on Rubber | 24 x 48 | 11 | 39 | 2000 | 90 |
| MN429 | 8" Mold-on Rubber | 30 x 60 | 11 | 39 | 2000 | 117 |
| MN430 | 8" Polyurethane | 24 x 48 | 11 | 39 | 2500 | 79 |
| MN431 | 8" Polyurethane | 30 x 60 | 11 | 39 | 2500 | 106 |
| MN432 | 10" Pneumatic | 24 x 48 | 13 | 41 | 1200 | 84 |
| MN433 | 10" Pneumatic | 30 x 60 | 13 | 41 | 1200 | 111 |
| MN434 | 10" Flat-Free | 24 x 48 | 13 | 41 | 1000 | 85 |
| MN435 | 10" Flat-Free | 30 x 60 | 13 | 41 | 1000 | 117 |
| MN436 | 8" Pneumatic | 24 x 48 | 11 | 39 | 1000 | 79 |
| MN437 | 8" Pneumatic | 30 x 60 | 11 | 39 | 1000 | 106 |
| MN438 | 8" Flat-Free | 24 x 48 | 11 | 39 | 900 | 80 |
| MN439 | 8" Flat-Free | 30 x 60 | 11 | 39 | 900 | 107 |

UTILITY CARTS & TROLLEYS

UTILITY CARTS

- Shelf design allows for quick and easy loading
- Light and easy to maneuver
- No. of Shelves: 3
- Cart Material: Plastic
- Wheel Material: Rubber
- Capacity: 250 lbs.
- Assembly required



| Model No. | Overall Depth" | Overall Width" | Overall Height" |
|-----------|----------------|----------------|-----------------|
| JH486 | 37-1/2 | 19-3/4 | 40-1/4 |
| JH487 | 33-1/2 | 16-3/4 | 37 |

TROLLEY

- Durable construction resistant to chipping and peeling
- Three convenient handle positions: up, 45° angle and folded down
- 5" rubber casters are resistant to marking
- Deck Width: 20-1/2"
- Deck Length: 31-3/4"
- Deck Height: 6"
- Handle Height: 27"
- Capacity: 500 lbs.
- Deck Material: Plastic

Model No. JH489



WIRE MESH OFFICE MAIL CART

- Ideal for carrying hanging folders, packages and office supplies
- Comes with three wire dividers and two removable baskets
- Shipped knocked down
- Capacity: 250 lbs.
- Overall Depth: 23"
- Overall Length: 42"
- Overall Height: 38"
- Cart Material: Chrome Plated
- No. of Shelves: 2
- No. of Baskets: 2

Model No. M0843



STEEL DECK PLATFORM TRUCKS

- All-welded design 14-gauge steel base
- 2" turned down lip and reinforced channels underneath
- Removable 1-1/4" chrome handle can be inserted in either end
 - Double welded sockets
 - Two swivel and two rigid bolted-on casters
 - KLETON blue powder coat finish
 - Shipped knocked-down





900 - LB. CAPACITY
Evenly Distributed

Plastic wheel with high impact strength and non-chipping properties. Resistant to oil, grease, and most chemicals.

MB246

STEEL DECKS - 5" POLYOLEFIN CASTERS

| Model No. | Platform Size | | | Deck Height" | Handle Height" | Wt. lbs. |
|--------------|---------------|---|----|--------------|----------------|----------|
| | W" | x | L" | | | |
| MB238 | 24 | x | 36 | 8 | 36 | 61 |
| MB246 | 24 | x | 48 | 8 | 36 | 74 |
| MD427 | 30 | x | 48 | 8 | 36 | 80 |
| MB254 | 30 | x | 60 | 8 | 36 | 94 |

REPLACEMENT PARTS

Model No. **ML396**, 5" Rigid Polyolefin Caster
 Model No. **ML337**, 5" Swivel Polyolefin Caster
 Model No. **MB218**, 24" Chrome Handle
 Model No. **MB221**, 30" Chrome Handle



1200 - LB. CAPACITY
Evenly Distributed

Great for uneven surfaces and carpeted areas. Quiet rolling casters make it ideal for institutional and industrial applications. Resists wet and corrosive chemical environments.

MB237

STEEL DECKS - 5" NON-MARKING RUBBER CASTERS

| Model No. | Platform Size | | | Deck Height" | Handle Height" | Wt. lbs. |
|--------------|---------------|---|----|--------------|----------------|----------|
| | W" | x | L" | | | |
| MB237 | 24 | x | 36 | 8 | 36 | 63 |
| MB245 | 24 | x | 48 | 8 | 36 | 76 |
| MD426 | 30 | x | 48 | 8 | 36 | 82 |
| MB253 | 30 | x | 60 | 8 | 36 | 96 |

REPLACEMENT PARTS

Model No. **ML338**, 5" Rigid Non-Marking Rubber Caster
 Model No. **ML337**, 5" Swivel Polyolefin Caster
 Model No. **MB218**, 24" Chrome Handle
 Model No. **MB221**, 30" Chrome Handle



1300 - LB. CAPACITY
Evenly Distributed

Solid black hi-temp nylon caster will not crush under heavy loads. It is good for use on all sorts of surfaces from wood to concrete. Will tolerate temperatures from -28°C to 230°C and is not affected by most corrosive chemicals.

MB240

STEEL DECKS - 6" HI-TEMP NYLON CASTERS

| Model No. | Platform Size | | | Deck Height" | Handle Height" | Wt. lbs. |
|--------------|---------------|---|----|--------------|----------------|----------|
| | W" | x | L" | | | |
| MB232 | 24 | x | 36 | 9 | 37 | 77 |
| MB240 | 24 | x | 48 | 9 | 37 | 90 |
| MD421 | 30 | x | 48 | 9 | 37 | 96 |
| MB248 | 30 | x | 60 | 9 | 37 | 110 |

REPLACEMENT PARTS

Model No. **ML862**, 6" Rigid Hi-Temp Nylon Caster
 Model No. **ML861**, 6" Swivel Hi-Temp Nylon Caster
 Model No. **MB218**, 24" Chrome Handle
 Model No. **MB221**, 30" Chrome Handle



- All-welded design 14-gauge steel base
- 2" turned down lip and reinforced channels underneath
- Double welded sockets
- Removable 1-1/4" chrome handle can be inserted in either end
- Two swivel and two rigid bolted-on casters
- KLETON blue powder coat finish
- Shipped knocked-down

STEEL DECK PLATFORM TRUCKS

STEEL DECKS - 8" HI-TEMP NYLON CASTERS

| Model No. | Platform Size | | | Deck Height" | Handle Height" | Wt lbs. |
|-----------|---------------|---|----|--------------|----------------|---------|
| | W" | x | L" | | | |
| MB233 | 24 | x | 36 | 11 | 39 | 87 |
| MB241 | 24 | x | 48 | 11 | 39 | 100 |
| MD422 | 30 | x | 48 | 11 | 39 | 106 |
| MB249 | 30 | x | 60 | 11 | 39 | 120 |

REPLACEMENT PARTS

- Model No. **ML865**, 8" Rigid Hi-Temp Nylon Caster
 Model No. **ML864**, 8" Swivel Hi-Temp Nylon Caster
 Model No. **MB218**, 24" Chrome Handle
 Model No. **MB221**, 30" Chrome Handle

1400 - LB. CAPACITY

Evenly Distributed



Solid black hi-temp nylon caster will not crush under heavy loads. It is good for use on all sorts of surfaces from wood to concrete. Will tolerate temperatures from -28°C to 230°C and is not affected by most corrosive chemicals.



MB241

STEEL DECKS - 8" MOLD-ON RUBBER CASTERS

| Model No. | Platform Size | | | Deck Height" | Handle Height" | Wt. lbs. |
|-----------|---------------|---|----|--------------|----------------|----------|
| | W" | x | L" | | | |
| MB236 | 24 | x | 36 | 11 | 39 | 96 |
| MB244 | 24 | x | 48 | 11 | 39 | 109 |
| MD425 | 30 | x | 48 | 11 | 39 | 115 |
| MB252 | 30 | x | 60 | 11 | 39 | 129 |

REPLACEMENT PARTS

- Model No. **ML853**, 8" Rigid Mold-On Rubber Caster
 Model No. **ML852**, 8" Swivel Mold-On Rubber Caster
 Model No. **MB218**, 24" Chrome Handle
 Model No. **MB221**, 30" Chrome Handle

1400 - LB. CAPACITY

Evenly Distributed



Molded rubber wheel bonded to a cast iron core. Iron core gives this caster strength while the rubber provides smooth and quiet rolling over multiple types of surfaces.



MB244

STEEL DECKS - 8" FULL PNEUMATIC CASTERS

| Model No. | Platform Size | | | Deck Height" | Handle Height" | Wt. lbs. |
|-----------|---------------|---|----|--------------|----------------|----------|
| | W" | x | L" | | | |
| MB234 | 24 | x | 36 | 11 | 39 | 79 |
| MB242 | 24 | x | 48 | 11 | 39 | 92 |
| MD423 | 30 | x | 48 | 11 | 39 | 98 |
| MB250 | 30 | x | 60 | 11 | 39 | 112 |

REPLACEMENT PARTS

- Model No. **MN221**, 8" Rigid Pneumatic Caster
 Model No. **MN222**, 8" Swivel Pneumatic Caster
 Model No. **MB218**, 24" Chrome Handle
 Model No. **MB221**, 30" Chrome Handle

1000 - LB. CAPACITY

Evenly Distributed



Air filled black rubber tire offers excellent shock absorbing properties. Smooth, quiet rolling over rough terrain and uneven surfaces. Not recommended for floors with corrosive chemicals or sharp objects.



MB242

HEAVY-DUTY PLATFORM TRUCKS

- Steel deck made of a heavy-duty all-welded 11-gauge steel with reinforced channel formed deck
- Wood deck features a sturdy 2" x 2" angle iron frame with quality hardwood decking
- Removable 1-1/4" chrome handle can be placed at either end
- Two rigid and two swivel bolted-on casters



2000 - LB. CAPACITY
Evenly Distributed



MB295



MB296

PLATFORM TRUCKS - 8" MOLD-ON RUBBER CASTERS

Molded rubber casters bonded to cast iron core. Iron core gives increased caster strength while the rubber provides smooth and quiet rolling over multiple types of surfaces.

STEEL DECK

| Platform Size" | Deck Height" | Handle Height" | Wt. lbs. | Standard Corner | Diamond Tilt |
|----------------|--------------|----------------|----------|-----------------|--------------|
| 24 x 48 | 11 | 40 | 110 | MB295 | MB297 |
| 30 x 48 | 11 | 40 | 130 | MB303 | MD331 |
| 30 x 60 | 11 | 40 | 140 | MB307 | MB309 |
| 36 x 72 | 11 | 40 | 175 | MB319 | MB321 |
| 48 x 96 | 11 | 40 | 240 | MB323 | MB325 |

WOOD DECK

| Platform Size" | Deck Height" | Handle Height" | Wt. lbs. | Standard Corner | Diamond Tilt |
|----------------|--------------|----------------|----------|-----------------|--------------|
| 24 x 48 | 11 | 40 | 110 | MB296 | MB298 |
| 30 x 48 | 11 | 40 | 130 | MB304 | MB306 |
| 30 x 60 | 11 | 40 | 140 | MB308 | MD332 |
| 36 x 72 | 11 | 40 | 175 | MB320 | MB322 |
| 48 x 96 | 11 | 40 | 240 | MB324 | MB326 |



2500 - LB. CAPACITY
Evenly Distributed



MB143



MB130

PLATFORM TRUCKS - 8" HI-TEMP NYLON CASTERS

Solid black hi-temp nylon casters will not rush under heavy loads. Good for use on all sorts of surfaces from wood to concrete. Will tolerate temperatures from -28°C to 230°C and is not affected by most corrosive chemicals

STEEL DECK

| Platform Size" | Deck Height" | Handle Height" | Wt. lbs. | Standard Corner | Diamond Tilt |
|----------------|--------------|----------------|----------|-----------------|--------------|
| 24 x 48 | 11 | 40 | 110 | MB131 | MB132 |
| 30 x 48 | 11 | 40 | 130 | MB139 | MB140 |
| 30 x 60 | 11 | 40 | 140 | MB143 | MB144 |
| 36 x 72 | 11 | 40 | 175 | MB154 | MB156 |
| 48 x 96 | 11 | 40 | 240 | MB167 | MB168 |

WOOD DECK

| Platform Size" | Deck Height" | Handle Height" | Wt. lbs. | Standard Corner | Diamond Tilt |
|----------------|--------------|----------------|----------|-----------------|--------------|
| 24 x 48 | 11 | 40 | 110 | MB130 | MB133 |
| 30 x 48 | 11 | 40 | 130 | MB138 | MB141 |
| 30 x 60 | 11 | 40 | 140 | MB142 | MB145 |
| 36 x 72 | 11 | 40 | 175 | MB155 | MB157 |
| 48 x 96 | 11 | 40 | 240 | MB166 | MB169 |



- Steel deck made of a heavy-duty all-welded 11-gauge steel with reinforced channel formed deck
- Wood deck features a sturdy 2" x 2" angle iron frame with quality hardwood decking
- Removable 1-1/4" chrome handle can be placed at either end
- Two rigid and two swivel bolted-on casters

HEAVY-DUTY PLATFORM TRUCKS

PLATFORM TRUCKS - 10" FULL PNEUMATIC CASTERS

- Pneumatic casters offer excellent shock absorbing properties
- Rides smoothly over rough terrain and uneven surfaces
- Not recommend for floors with corrosive chemicals or sharp objects



1200 - LB. CAPACITY
Evenly Distributed

STEEL DECK

| Platform Size" | Deck Height" | Handle Height" | Wt. lbs. | Standard Corner | Diamond Tilt |
|----------------|--------------|----------------|----------|-----------------|--------------|
| 24 x 48 | 13 | 42 | 110 | MB255 | MB257 |
| 30 x 48 | 13 | 42 | 130 | MB263 | MB265 |
| 30 x 60 | 13 | 42 | 140 | MB268 | MB269 |
| 36 x 72 | 13 | 42 | 175 | MB280 | MB281 |
| 48 x 96 | 13 | 42 | 240 | MB283 | MB285 |

WOOD DECK

| Platform Size" | Deck Height" | Handle Height" | Wt. lbs. | Standard Corner | Diamond Tilt |
|----------------|--------------|----------------|----------|-----------------|--------------|
| 24 x 48 | 13 | 42 | 110 | MB256 | MB258 |
| 30 x 48 | 13 | 42 | 130 | MB264 | MB266 |
| 30 x 60 | 13 | 42 | 140 | MB267 | MB270 |
| 36 x 72 | 13 | 42 | 175 | MB279 | MB282 |
| 48 x 96 | 13 | 42 | 240 | MB284 | MB286 |



MB263



MB267

CASTER PLACEMENT



STANDARD

Standard corner pattern is two swivel wheels in the back and two rigid wheels in the front of the platform truck



DIAMOND

Diamond tilt pattern allows the truck to tilt-balance slightly on the centre side wheels, allowing the truck to turn in its own length

REPLACEMENT CASTERS

| Model No. | Description |
|-----------|--------------------------|
| ML853 | 8" Mold-on Rubber Rigid |
| ML852 | 8" Mold-on Rubber Swivel |
| ML865 | 8" Hi-Temp Nylon Rigid |
| ML864 | 8" Hi-Temp Nylon Swivel |
| MN223 | 10" Pneumatic Rigid |
| MN224 | 10" Pneumatic Swivel |



ML853



ML852



ML865



ML864



MN223



MN224

REPLACEMENT HANDLES

| Model No. | Description |
|-----------|-------------------|
| MB218 | 24" Chrome Handle |
| MB221 | 30" Chrome Handle |
| MB224 | 36" Chrome Handle |
| MB226 | 48" Chrome Handle |



ALL WOOD DECK PLATFORM TRUCKS

- Made of quality 7/8" hardwood with 5" x 1-5/8" hardwood sidewall
- Hardwood surface will not mar or scratch loads
- Removable 1-1/4" tubular chrome handle
- Mounted on two 12" wheels and two 6" swivel hi-temp nylon casters



MB122

**3000 - LB.
CAPACITY**
Evenly Distributed

| Model No. | Platform Size | | | Deck Height" | Handle Height" | Wt. lbs. |
|-----------|---------------|---|----|--------------|----------------|----------|
| | W" | x | L" | | | |
| MB122 | 24 | x | 48 | 15 | 44 | 150 |
| MB123 | 30 | x | 48 | 15 | 44 | 170 |
| MB124 | 30 | x | 60 | 15 | 44 | 195 |
| MB125 | 36 | x | 60 | 15 | 44 | 210 |
| MB126 | 36 | x | 72 | 15 | 44 | 230 |

REPLACEMENT PARTS

- Model No. **MC340**, 12" Phenolic Wheel
 Model No. **ML861**, 6" Swivel Hi-Temp Nylon Caster
 Model No. **MB218**, 24" Chrome Handle
 Model No. **MB221**, 30" Chrome Handle
 Model No. **MB224**, 36" Chrome Handle

PLATFORM WAGON TRUCKS

- Flush deck allows for easy loading/unloading of cargo
- Steel deck made of an all-welded 11-gauge steel
- Wood deck features a 2" x 2" angle iron frame with quality hardwood decking
- Ergonomic handle can be raised up to 45"
- Fifth wheel design allows for easier maneuvering
- T-handle with vinyl handgrips
- Rolls on four 10" pneumatic wheels
- Durable KLETON blue enamel finish



MD189

**1000 - LB.
CAPACITY**
Evenly Distributed

| STEEL DECK | | | WOOD DECK | | | | |
|------------|----------|--|-----------|----------|--|-----------------------|--------------|
| Model No. | Wt. lbs. | | Model No. | Wt. lbs. | | Platform Size W" x L" | Deck Height" |
| MD187 | 130 | | MD186 | 120 | | 24 x 48 | 14-1/4 |
| MD189 | 170 | | MD188 | 150 | | 30 x 60 | 14-1/4 |
| MD193 | 210 | | MD192 | 190 | | 36 x 72 | 14-1/4 |

REPLACEMENT PARTS

- Model No. **MA382**, Hand Grip
 Model No. **ML069**, 10" Pneumatic Wheel



MN413

ELEVATED PLATFORM TRUCKS

- All-welded steel construction, ready-to-use
- 11-gauge steel deck with 2" square tube frames
- 1-1/4" round tube handle extends 14" above deck
- Removable handle
- Durable KLETON blue enamel finish

| Model No. | Platform Size | | | Deck Height" | Wheel Type | Capacity lbs. |
|-----------|---------------|---|----|--------------|-------------------|---------------|
| | W" | x | L" | | | |
| MN413 | 24 | x | 48 | 28 | 8" Hi-Temp Nylon | 2000 |
| MN414 | 30 | x | 60 | 28 | 8" Hi-Temp Nylon | 2000 |
| MN415 | 24 | x | 48 | 28 | 8" Mold-On Rubber | 1800 |
| MN416 | 30 | x | 60 | 28 | 8" Mold-On Rubber | 1800 |
| MN417 | 24 | x | 48 | 31 | 10" Pneumatic | 1000 |
| MN418 | 30 | x | 60 | 31 | 10" Pneumatic | 1000 |



Customize KLETON
products to your specs!
See Inside Front Cover

SPECIALIZED PLATFORM TRUCKS

SEMI LIVE SKIDS

- Ideal solution for removable temporary storage
- Heavy 11-gauge steel deck with reinforced channels
- 3/16" x 2" x 2" angle frame with hardwood deck
- 52" jack handle (sold separately) engages skids and converts them to portable truck
- Skids and handle roll on 8" Mold-on rubber wheels
- Can be stacked away when not in use
- Durable KLETON blue enamel finish

**2000 - LB.
CAPACITY**
Evenly Distributed



MB327



MB348



MB328

| Model No. | Deck Size W" x L" | Deck Type | Deck Height" | Wt. lbs. |
|-----------|-------------------|-----------|--------------|----------|
| MB327 | 24 x 48 | Steel | 12 | 110 |
| MB328 | 24 x 48 | Wood | 12 | 115 |
| MB329 | 30 x 48 | Steel | 12 | 130 |
| MB330 | 30 x 48 | Wood | 12 | 135 |
| MB331 | 30 x 60 | Steel | 12 | 140 |
| MB332 | 30 x 60 | Wood | 12 | 145 |
| MB337 | 36 x 72 | Steel | 12 | 175 |
| MB338 | 36 x 72 | Wood | 12 | 180 |
| MB348 | 51" Jack Handle | | | 30 |

REPLACEMENT PARTS

Model No. **ML853**, 8" Rigid Mold-On Rubber Wheel

DEAD SKIDS

- Tough and durable platforms for temporary storage and handling of material
- Heavy 11-gauge steel deck with reinforced channels
- 3/16" x 2" x 2" angle frame with hardwood deck
- Available with steel or hardwood decks
- Four sturdy steel legs keep loads off the floor
- Can be stacked when not in use
- Durable KLETON blue enamel finish

**2500 - LB.
CAPACITY**
Evenly Distributed



ML071



ML072

| Model No. | Deck Size W" x L" | Platform Type | Deck Height" | Wt. lbs. |
|-----------|-------------------|---------------|--------------|----------|
| ML071 | 24 x 48 | Steel | 6 | 110 |
| ML072 | 24 x 48 | Wood | 6 | 115 |
| ML073 | 30 x 48 | Steel | 6 | 130 |
| ML074 | 30 x 48 | Wood | 6 | 135 |
| ML075 | 30 x 60 | Steel | 6 | 140 |
| ML076 | 30 x 60 | Wood | 6 | 145 |
| ML077 | 36 x 72 | Steel | 6 | 175 |
| ML078 | 36 x 72 | Wood | 6 | 180 |

INSTITUTIONAL & FOLDABLE PLATFORM TRUCKS

INSTITUTIONAL PLATFORM TRUCKS

- All-welded 14-gauge steel platform
- Ideal for hospitals, restaurants, offices and any application where a professional appearance is required
- Double-welded sockets
- 2" turned down lip and reinforced channels underneath
- 1-1/4" tubular chrome handle with end panel
- Non-skid rubber mat surface prevents items from shifting and protects against scratches
- Rubber corner bumpers protect furniture and walls
- Two rigid and two swivel 5" bolted-on non-marking rubber casters
- KLETON blue powder coat finish
- Shipped knocked down



MB190

1200 - LB. CAPACITY
Evenly Distributed



| Model No. | Platform Size W" x L" x H" | Handle Height" | Overall Dimensions W" x L" x H" | Wt. lbs. |
|-----------|----------------------------|----------------|---------------------------------|----------|
| MB190 | 24 x 36 x 8 | 36 | 26 x 38 x 36 | 64 |
| MB208 | 24 x 48 x 8 | 36 | 26 x 50 x 36 | 70 |
| MB207 | 30 x 48 x 8 | 36 | 32 x 50 x 36 | 88 |
| MB209 | 30 x 60 x 8 | 36 | 32 x 62 x 36 | 100 |

REPLACEMENT PARTS

- Model No. **MB220**, 24" Chrome Handle with Plate
- Model No. **MB223**, 30" Chrome Handle with Plate
- Model No. **MC043**, Corner Bumper
- Model No. **ML338**, 5" Rigid Non-Marking Rubber Caster
- Model No. **ML337**, 5" Swivel Non-Marking Rubber Caster

FOLDING HANDLE PLATFORM TRUCKS

- Ideal for moving supplies, forms and light equipment
- Heavy 16-gauge steel construction with non skid vinyl coated deck
- Entire platform is wrapped with a vinyl bumper to protect walls and furniture
- Quick-release handle folds flat for easy storage
- Two swivel and two rigid bolted-on rubber casters

440 - 660 - LB. CAPACITY
Evenly Distributed



MK989

| Model No. | Platform Size W" x L" | Handle Height" | Caster Size | Folded Height" | Wt. lbs. |
|-----------|-----------------------|----------------|-------------|----------------|----------|
| MK988 | 19 x 29 | 33 | 4" | 8 | 22 |
| MK989 | 23 x 35 | 33 | 5" | 9 | 42 |

REPLACEMENT PARTS

- Model No. **M0826**, 4" Rigid Rubber Caster
- Model No. **M0827**, 4" Swivel Rubber Caster
- Model No. **M0828**, 5" Rigid Rubber Caster
- Model No. **M0829**, 5" Swivel Rubber Caster

FOLDABLE ALUMINUM PLATFORM TRUCKS

- Designed for situations that call for a solid, yet portable platform truck
- Interlocking aluminum frame has dual length platform: 20" L x 16" W or 28" L x 16" W
- Rubber corner bumpers to protect walls and furniture
- Folds down to a compact 20" L x 16" W x 9 1/2" H
- Comfortable 32" handle height
- Two swivel and two rigid bolted-on 4" rubber casters
- Weight: 19 lbs.

Model No. **MK990**

REPLACEMENT PARTS

- Model No. **M0830**, 4" Rigid Rubber Caster
- Model No. **M0831**, 4" Swivel Rubber Caster



300 - LB. CAPACITY
Evenly Distributed



ALUMINUM PLATFORM TRUCKS

- Box frame made of high strength all-welded aluminum channel
- Corner sockets at both ends allow handles to be used on either end of the truck
- Rubber corner bumpers prevent damage to walls and furniture
- Wide variety of casters to suit any application

ALUMINUM PLATFORM TRUCKS



ML901



| | | SMOOTH DECK | | TREAD PLATE DECK | |
|-----------------------------|---------------|-------------|----------|------------------|----------|
| Platform Size" | Capacity lbs. | Model No. | Wt. lbs. | Model No. | Wt. lbs. |
| 8" PNEUMATIC CASTERS | | | | | |
| 24 x 36 | 1400 | ML901 | 54 | ML904 | 54 |
| 24 x 48 | 1400 | ML902 | 60 | ML905 | 60 |
| 30 x 60 | 1400 | ML903 | 72 | ML906 | 72 |



ML910



| | | SMOOTH DECK | | TREAD PLATE DECK | |
|------------------------------|---------------|-------------|----------|------------------|----------|
| Platform Size" | Capacity lbs. | Model No. | Wt. lbs. | Model No. | Wt. lbs. |
| 10" PNEUMATIC CASTERS | | | | | |
| 24 x 36 | 1600 | ML907 | 54 | ML910 | 60 |
| 24 x 48 | 1600 | ML908 | 60 | ML911 | 65 |
| 30 x 60 | 1600 | ML909 | 72 | ML912 | 80 |



ML916



| | | SMOOTH DECK | | TREAD PLATE DECK | |
|-----------------------------|---------------|-------------|----------|------------------|----------|
| Platform Size" | Capacity lbs. | Model No. | Wt. lbs. | Model No. | Wt. lbs. |
| 8" FLAT-FREE CASTERS | | | | | |
| 24 x 36 | 1100 | ML913 | 56 | ML916 | 57 |
| 24 x 48 | 1100 | ML914 | 62 | ML917 | 62 |
| 30 x 60 | 1100 | ML915 | 74 | ML918 | 76 |



ML922



| | | SMOOTH DECK | | TREAD PLATE DECK | |
|------------------------------|---------------|-------------|----------|------------------|----------|
| Platform Size" | Capacity lbs. | Model No. | Wt. lbs. | Model No. | Wt. lbs. |
| 10" FLAT-FREE CASTERS | | | | | |
| 24 x 36 | 1200 | ML919 | 61 | ML922 | 62 |
| 24 x 48 | 1200 | ML920 | 67 | ML923 | 67 |
| 30 x 60 | 1200 | ML921 | 79 | ML924 | 81 |

ALUMINUM PLATFORM TRUCKS

ALUMINUM PLATFORM TRUCKS

- Box frame made of high strength all-welded aluminum channel
- Corner sockets at both ends allow handles to be used on either end of the truck
- Rubber corner bumpers prevent damage to walls and furniture
- Wide variety of casters to suit any application



| | | SMOOTH DECK | | TREAD PLATE DECK | |
|----------------------------------|---------------|--------------|----------|------------------|----------|
| 8" MOLD-ON RUBBER CASTERS | | | | | |
| Platform Size" | Capacity lbs. | Model No. | Wt. lbs. | Model No. | Wt. lbs. |
| 24 x 36 | 2000 | ML925 | 65 | ML928 | 66 |
| 24 x 48 | 2000 | ML926 | 71 | ML929 | 71 |
| 30 x 60 | 2000 | ML927 | 83 | ML930 | 85 |



| | | SMOOTH DECK | | TREAD PLATE DECK | |
|--------------------------------|---------------|--------------|----------|------------------|----------|
| 6" POLYURETHANE CASTERS | | | | | |
| Platform Size" | Capacity lbs. | Model No. | Wt. lbs. | Model No. | Wt. lbs. |
| 24 x 36 | 3400 | ML931 | 50 | ML934 | 51 |
| 24 x 48 | 3400 | ML932 | 56 | ML935 | 56 |
| 30 x 60 | 3400 | ML933 | 68 | ML936 | 70 |



| | | SMOOTH DECK | | TREAD PLATE DECK | |
|--------------------------------|---------------|--------------|----------|------------------|----------|
| 8" POLYURETHANE CASTERS | | | | | |
| Platform Size" | Capacity lbs. | Model No. | Wt. lbs. | Model No. | Wt. lbs. |
| 24 x 36 | 4000 | ML937 | 55 | ML940 | 56 |
| 24 x 48 | 4000 | ML938 | 61 | ML941 | 61 |
| 30 x 60 | 4000 | ML939 | 73 | ML942 | 75 |

HARDWOOD DOLLIES

HARDWOOD DOLLIES

- Kiln dried
- Countersunk bolts prevent scratches
- Wood thickness: 7/8"
- Rounded edges and handles facilitate storage and movability
- Shipped knocked down



CHOOSE FROM 3 CASTER TYPES



POLYOLEFIN



BLUE ELASTIC
RUBBER



POLYURETHANE

| Model No. | Size W" x D" | Caster Type | Caster Size" | Capacity lbs.* |
|-----------------|--------------|--------------|--------------|----------------|
| ALL-WOOD | | | | |
| MN189 | 18 x 24 | Polyolefin | 3 | 900 |
| MN195 | 18 x 24 | Polyurethane | 3 | 900 |
| MN201 | 18 x 24 | Polyolefin | 4 | 1000 |
| MN207 | 18 x 24 | Polyurethane | 4 | 1600 |
| MN213 | 18 x 24 | Blue Elastic | 4 | 1400 |
| MN192 | 18 x 30 | Polyolefin | 3 | 900 |
| MN198 | 18 x 30 | Polyurethane | 3 | 900 |
| MN204 | 18 x 30 | Polyolefin | 4 | 1000 |
| MN210 | 18 x 30 | Polyurethane | 4 | 1600 |
| MN216 | 18 x 30 | Blue Elastic | 4 | 1400 |

CARPETED ENDS

| | | | | |
|-------|---------|--------------|---|------|
| MN190 | 18 x 24 | Polyolefin | 3 | 900 |
| MN196 | 18 x 24 | Polyurethane | 3 | 900 |
| MN202 | 18 x 24 | Polyolefin | 4 | 1000 |
| MN208 | 18 x 24 | Polyurethane | 4 | 1600 |
| MN214 | 18 x 24 | Blue Elastic | 4 | 1400 |
| MN193 | 18 x 30 | Polyolefin | 3 | 900 |
| MN199 | 18 x 30 | Polyurethane | 3 | 900 |
| MN205 | 18 x 30 | Polyolefin | 4 | 1000 |
| MN211 | 18 x 30 | Polyurethane | 4 | 1600 |
| MN217 | 18 x 30 | Blue Elastic | 4 | 1400 |

RUBBER ENDS

| | | | | |
|-------|---------|--------------|---|------|
| MN191 | 18 x 24 | Polyolefin | 3 | 900 |
| MN197 | 18 x 24 | Polyurethane | 3 | 900 |
| MN203 | 18 x 24 | Polyolefin | 4 | 1000 |
| MN209 | 18 x 24 | Polyurethane | 4 | 1600 |
| MN215 | 18 x 24 | Blue Elastic | 4 | 1400 |
| MN194 | 18 x 30 | Polyolefin | 3 | 900 |
| MN200 | 18 x 30 | Polyurethane | 3 | 900 |
| MN206 | 18 x 30 | Polyolefin | 4 | 1000 |
| MN212 | 18 x 30 | Polyurethane | 4 | 1600 |
| MN218 | 18 x 30 | Blue Elastic | 4 | 1400 |

*Evenly distributed

REPLACEMENT CASTERS

Model No. **ML391**, 3" Swivel Polyolefin

Model No. **ML393**, 4" Swivel Polyolefin

Model No. **ML044**, 3" Swivel Polyurethane

Model No. **ML045**, 4" Swivel Polyurethane

Model No. **ML333**, 4" Swivel Blue Elastic Rubber



* Dolly not included

WOOD DOLLY RACKS

- Converts a basic wood dolly into a multi-purpose panel caddy
- All-welded 1" tube design for durability
- Tubular steel rack is padded to prevent scratching or marring
- Durable KLETON blue enamel finish

| Model No. | For Use with Wood Dollies | Overall Dimensions W" x D" x H" | Between Rail Clearance" | Wt. lbs. |
|-----------|---------------------------|---------------------------------|-------------------------|----------|
| MD549 | 24" D | 18 x 24 x 43 | 16 | 16.0 |
| MD550 | 30" D | 18 x 30 x 43 | 16 | 18.4 |



STEEL DECK DOLLIES

- Rugged dolly ideal for moving heavy loads
- 14-gauge steel construction
- Four bolted-on 4" swivel non-marking rubber casters
- Durable KLETON blue enamel finish



Optional T-handle facilitates movement with heavy loads



1200 - LB. CAPACITY
Evenly Distributed

| Model No. | Overall Dimensions W" x L" x H" | Wt. lbs. |
|-----------|------------------------------------|----------|
| MA242 | 18 x 18 x 7 | 16.0 |
| MA243 | 18 x 24 x 7 | 19.6 |
| MA244 | 24 x 24 x 7 | 24.4 |
| MA199 | 37" Length T-handle | 5.8 |

REPLACEMENT PARTS

Model No. **ML333**, 4" Swivel Non-Marking Rubber Caster
Model No. **MA382**, Replacement Handgrip for T-Handle

ANGLE FRAME DOLLIES

- Heavy-duty all-welded 1/2" x 1/2" x 1/8" angle frame construction
- Built to withstand tough factory and warehouse environments
- Four bolted-on 4" swivel non-marking rubber casters
- Durable KLETON blue enamel finish



1200 - LB. CAPACITY
Evenly Distributed

| Model No. | Overall Dimensions W" x L" x H" | Wt. lbs. |
|-----------|------------------------------------|----------|
| MA190 | 18 x 18 x 7 | 19.3 |
| MA191 | 18 x 24 x 7 | 17.8 |
| MA192 | 24 x 24 x 7 | 22.1 |
| MA193 | 24 x 36 x 7 | 22.8 |

REPLACEMENT PARTS

Model No. **ML333**, 4" Swivel Non-Marking Rubber Caster

ALUMINUM DECK DOLLIES

- Ideal for a variety of transport applications
- 3/8" corrosion-resistant aluminum checker plate construction
- Four bolted-on 4" swivel non-marking rubber casters
- Natural aluminum finish

| Model No. | Overall Dimensions W" x L" x H" | Wt. lbs. |
|-----------|------------------------------------|----------|
| MA196 | 18 x 18 x 6 | 20.2 |
| MA197 | 18 x 24 x 6 | 25.0 |
| MA198 | 24 x 24 x 6 | 29.0 |

Tread plate design for a non-slip load surface!



1200 - LB. CAPACITY
Evenly Distributed

REPLACEMENT PARTS

Model No. **ML333**, 4" Swivel Non-Marking Rubber Caster

PREMIUM MEDIUM-DUTY 100% MAPLE WOOD DOLLIES

- 7/8" wood top; countersunk bolts
- Carpeted dolly will prevent marks and scratches on equipment being moved
- 3" polyolefin casters
- Shipped knocked down



900 - LB. CAPACITY
Evenly Distributed

| Model No. | Dimensions W" x D" | Platform Type | Wt. lbs. |
|-----------|-----------------------|---------------|----------|
| MA186 | 18 x 24 | Standard | 16.4 |
| MA187 | 18 x 24 | Carpeted | 19.6 |
| MD515 | 18 x 30 | Standard | 18.0 |
| MD516 | 18 x 30 | Carpeted | 20.0 |

PREMIUM HEAVY-DUTY 100% MAPLE WOOD DOLLIES

- 1 3/4" wood top (2 x 7/8" pieces); countersunk bolts
- 4" resilient non-marking casters
- Shipped knocked down



1400 - LB. CAPACITY
Evenly Distributed

Carpeted dolly will prevent marks and scratches on equipment

| Model No. | Dimensions W" x D" | Platform Type | Wt. lbs. |
|-----------|-----------------------|---------------|----------|
| MA188 | 18 x 24 | Standard | 20.2 |
| MA189 | 18 x 24 | Carpeted | 18.5 |
| MD517 | 18 x 30 | Standard | 22.0 |
| MD518 | 18 x 30 | Carpeted | 24.0 |

SPECIALIZED DOLLIES AND TRUCKS

MEDIUM-DUTY SOLID WOOD DOLLIES

- 7/8" wood top with countersunk bolts
- 3" polyolefin casters
- Shipped knocked down



MP089



**900 - LB.
CAPACITY**
Evenly Distributed

| Model No. | Overall Dimensions W" x L" x H" | Description | Wt. lbs. |
|-----------|------------------------------------|-------------|-------------|
| MP087 | 18 x 24 x 7 | Wood-Top | 22.0 |
| MP088 | 18 x 24 x 7 | Carpeted | 22.4 |
| MP089 | 18 x 32 x 7 | Wood-Top | 26.0 |
| MP090 | 18 x 32 x 7 | Carpeted | 26.8 |

HEAVY-DUTY SOLID WOOD DOLLIES

- 1-3/4" wood top (2 x 7/8" pieces) with countersunk bolts
- 4" resilient non-marking casters
- Shipped knocked down



MP094



**1400 - LB.
CAPACITY**
Evenly Distributed

| Model No. | Overall Dimensions W" x L" x H" | Description | Wt. lbs. |
|-----------|------------------------------------|-------------|-------------|
| MP091 | 18 x 24 x 7 | Wood-Top | 26.3 |
| MP092 | 18 x 24 x 7 | Carpeted | 27.8 |
| MP093 | 18 x 32 x 7 | Wood-Top | 28.5 |
| MP094 | 18 x 32 x 7 | Carpeted | 30.7 |

PIPE & BAR CRADLE TRUCK

- All-welded steel construction, ready to use
- Raised ergonomic bed height of 20" is ideal for shop environment
- Cradle is 19-1/2" W x 14" H
- 6" heavy-duty swivel casters allow for greater maneuverability in tight spaces and can turn on their axes
- Single units are ideal for shorter loads and must be centered on the truck; multiple units can be combined for greater capacity and to support longer loads
- Recessed side decks allow for loading and unloading with a lift truck
- Durable KLETON blue enamel finish



**2500 - LB.
CAPACITY**
Evenly Distributed

| Model No. | Overall Dimensions W" x L" x H" | Wt. lbs. |
|-----------|------------------------------------|-------------|
| MP037 | 24 x 24 x 34 | 93 |
| MP038 | 24 x 36 x 34 | 104 |
| MP039 | 24 x 48 x 34 | 113 |

PALLET DOLLY

- Fits most standard pallets up to 42" x 48"
- Can be used with loaded or empty pallets
- (4) 6" swivel polyurethane casters, (2) with brakes
- Rugged, angle iron construction with load retention corner brackets
- 3000 lbs capacity
- Dimensions: 48-1/2" W x 43" D x 8" H

Model No. **MP044**



FRAME SHEET/PANEL CARTS

- Frame is constructed of all-welded 2" angle steel
- Ideal for handling long, flat, awkward loads
- Available with open or closed base
- Four bolted-on 5" non-marking rubber swivel casters
- Durable KLETON blue enamel finish

**1200 - LB.
CAPACITY**
Evenly Distributed



ML064



MD217

| Model No. | Overall Dimensions D" x W" x H" | Base Type | Wt. lbs. |
|-----------|------------------------------------|-----------|----------|
| MD216 | 36 x 24 x 55 | Open | 50 |
| ML063 | 36 x 24 x 55 | Closed | 60 |
| MD217 | 42 x 30 x 55 | Open | 79 |
| ML064 | 42 x 30 x 55 | Closed | 75 |
| MD218 | 72 x 36 x 55 | Open | 85 |
| ML065 | 72 x 36 x 55 | Closed | 110 |

REPLACEMENT PARTS

Model No. **ML337**, 5" Swivel Non-Marking Rubber

U-BOAT PLATFORM TRUCKS

- Tilt design allows truck to turn within its own radius
- 11-gauge steel deck is only 10" off the ground for easy loading
- Removable end racks constructed of 1-1/4" round steel tube
- Two 8" x 2" bolted-on rigid casters and four 5" swivel casters
- Durable KLETON blue enamel finish



MK970

**1500 - LB.
CAPACITY**
Evenly Distributed

| Model No. | Overall Dimensions W" x D" x H" | Wt. lbs. |
|-----------|------------------------------------|----------|
| MK970 | 48 x 18 x 72 | 125 |
| MK971 | 60 x 18 x 72 | 80 |

REPLACEMENT PARTS

Model No. **ML853**, 8" Rigid Mold-On Rubber

Model No. **ML846**, 5" Swivel Mold-On Rubber

BAR CRADLE CARTS

- Designed for efficient handling of long material
- Tilt design allows truck to turn within its own radius
- Cradle design facilitates loading and unloading
- Two 12" phenolic wheels and two 6" swivel hi-temp nylon casters
- Durable KLETON blue enamel finish

| Model No. | Overall Dimensions D" x W" x H" | No. of cradles | Wt. lbs. |
|-----------|------------------------------------|----------------|----------|
| ML128 | 60 x 28 x 29 | 4 | 278 |
| ML130 | 96 x 28 x 29 | 4 | 311 |
| ML131 | 120 x 28 x 29 | 4 | 331 |

REPLACEMENT PARTS

Model No. **MC340**, 12" Phenolic Wheel

Model No. **ML861**, 6" Hi-Temp Nylon Swivel Caster



ML131

**5000-LB.
CAPACITY**



Customize KLETON products to your specs!
See Inside Front Cover

SPECIALIZED CARTS



ML139

DRYWALL CARTS

- All-welded multi-purpose cart is ideal for transporting drywall, wood or metal sheets
- 1-1/4" tubular rail handle and thick 11-gauge steel platform
- Two rigid and two swivel 8" bolted-on casters
- KLETON blue enamel finish

2000-3500 - LB. CAPACITY
Evenly Distributed

| Model No. | Deck Dim. W" x L" x H" | Deck Angle° | Overall Dim. W" x L" x H" | Cap. lbs. | Caster Type | Wt. lbs. |
|-----------|------------------------|-------------|---------------------------|-----------|-------------------|----------|
| ML139 | 15 x 44 x 14 | 80 | 24 x 44 x 44 | 2000 | 8" Mold-on Rubber | 98 |
| MD214 | 15 x 44 x 14 | 80 | 24 x 44 x 44 | 3500 | 8" Polyurethane | 97 |

REPLACEMENT PARTS

- Model No. **ML402**, 8" Rigid Polyurethane
Model No. **ML401**, 8" Swivel Polyurethane
Model No. **ML853**, 8" Rigid Mold-On Rubber
Model No. **ML852**, 8" Swivel Mold-On Rubber



MB729

LUMBER CARTS

- All-welded cart is ideal for transporting long and bulky items
- Welded 14-gauge 12" x 38" steel shelf
- Grey rubber bumpers protect walls and equipment
- Two rigid and two swivel bolted-on casters
- KLETON blue enamel finish

1200 - LB. CAPACITY
Evenly Distributed

| Model No. | Deck Dim. W" x L" x H" | Shelf Height" | Overall Dim. W" x L" x H" | Caster Type | Wt. lbs |
|-----------|------------------------|---------------|---------------------------|-------------|---------|
| MB729 | 24 x 36 x 8 | 34 | 26 x 39 x 42 | 5" Rubber | 79 |
| ML140 | 24 x 36 x 10 | 36 | 26 x 39 x 45 | 6" Rubber | 102 |

REPLACEMENT PARTS

- Model No. **ML338**, 5" Rigid Non-Marking Rubber Caster
Model No. **ML337**, 5" Swivel Non-Marking Rubber Caster
Model No. **ML850**, 6" Rigid Mold-On Rubber Caster
Model No. **ML849**, 6" Swivel Mold-On Rubber Caster
Model No. **MC043**, Grey Rubber Corner Bumper

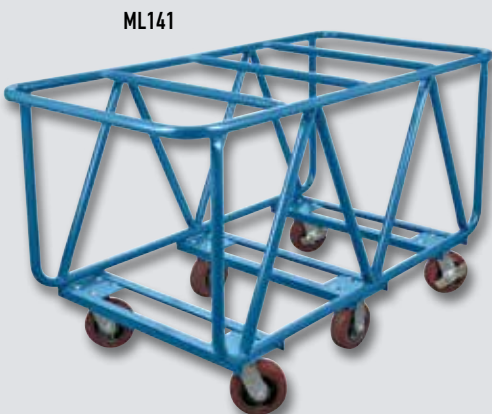

ML141

FLAT BED LUMBER CARTS

- All-welded cart is ideal for transporting large panel or sheets in a horizontal position
- Four 6" swivel and two 6" rigid bolted-on non-marking polyurethane casters
- KLETON blue enamel finish

2500 - LB. CAPACITY
Evenly Distributed

| Model No. | Overall Dimensions W" x D" x H" | Wt. lbs |
|-----------|---------------------------------|---------|
| ML141 | 30 x 60 x 33 | 160 |

REPLACEMENT PARTS

- Model No. **ML400**, 6" Rigid Polyurethane
Model No. **ML399**, 6" Swivel Polyurethane



HEAVY-DUTY PANEL AND LUMBER MOVER CARTS

- All-welded truck ideal for transporting large sheets and long parts
- Constructed from 1-1/4" round tubing and an 11-gauge deck
- Uprights extend 21" and 33" above deck
- Deck is 12" off the floor
- 8" clear space between tubes
- Two rigid and two swivel 8" casters
- Durable KLETON blue enamel finish

**2000-2500 - LB.
CAPACITY**
Evenly Distributed



ML360

| Model No. | Dimensions W" x L" x H" | Caster Type | Cap. lbs. | Wt. lbs. |
|-----------|-------------------------|----------------|-----------|----------|
| ML360 | 30 x 48 x 45 | Mold-on Rubber | 2000 | 160 |
| ML361 | 30 x 48 x 45 | Polyurethane | 2500 | 175 |
| ML362 | 30 x 60 x 45 | Mold-on Rubber | 2000 | 160 |
| ML363 | 30 x 60 x 45 | Polyurethane | 2500 | 175 |

REPLACEMENT PARTS

- Model No. **ML401**, 8" Swivel Polyurethane
 Model No. **ML852**, 8" Swivel Mold-On Rubber
 Model No. **ML402**, 8" Rigid Polyurethane
 Model No. **ML853**, 8" Rigid Mold-On Rubber

SINGLE LEVEL RAILS HEAVY-DUTY PANEL MOVER CARTS

- All-welded truck ideal for transporting large sheets and long parts
- Constructed from 1-1/4" round tubing and an 11-gauge deck
- Uprights extend 33" above deck
- Deck is 12" off the floor
- Overall height is 45"
- 8" clear space between tubes
- Two rigid and two swivel 8" casters
- Durable KLETON blue enamel finish

**2000-2500 - LB.
CAPACITY**
Evenly Distributed



ML549

| Model No. | Dimensions W" x L" x H" | Caster Type | Cap. lbs. | Wt. lbs. |
|-----------|-------------------------|----------------|-----------|----------|
| ML549 | 30 x 48 x 45 | Mold-on Rubber | 2000 | 139 |
| ML550 | 30 x 48 x 45 | Polyurethane | 2500 | 139 |
| ML551 | 30 x 60 x 45 | Mold-on Rubber | 2000 | 161 |
| ML552 | 30 x 60 x 45 | Polyurethane | 2500 | 161 |

REPLACEMENT PARTS

- Model No. **ML401**, 8" Swivel Polyurethane
 Model No. **ML852**, 8" Swivel Mold-On Rubber
 Model No. **ML402**, 8" Rigid Polyurethane
 Model No. **ML853**, 8" Rigid Mold-On Rubber

HEAVY-DUTY WORKHORSES

- Overbuilt to be the last sawhorse you'll ever need
- Powder coated finish safety yellow
- Material: Steel

**2000 - LB.
CAPACITY**
Evenly Distributed

| Model No. | Height" | Width" | Depth" | Wt. lbs. |
|-----------|---------|--------|--------|----------|
| VC157 | 24 | 36 | 20 | 43 |
| VC158 | 36 | 20 | 57 | |

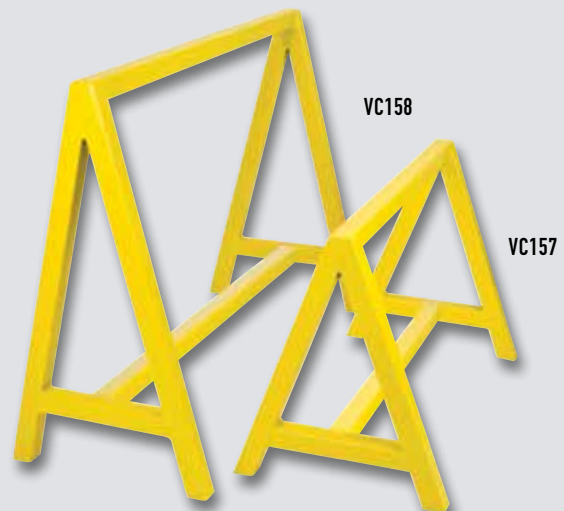

VC158

VC157



Customize KLETON products to your specs!
See Inside Front Cover

SPECIALIZED TRUCKS & CARTS



KNOCKED-DOWN PANEL TRUCKS

- Move tables, drywall, plywood, artwork with ease
- Move light to heavy duty objects easily with (4) 5" non-marking blue elastic swivel casters
- Removable upright panel bars fit any size load
- Ships knocked-down for freight savings and damage avoidance
- Capacity is based on evenly distributed weight



| Model No. | Deck Type | Overall Dimensions W" x L" x H" | Caster Size | Capacity lbs |
|-----------|-----------|---------------------------------|-------------|--------------|
| M0522 | Open-Deck | 27 x 30 x 43 | 5" Rubber | 1000 |
| M0523 | Carpeted | 27 x 30 x 43 | 5" Rubber | 1000 |

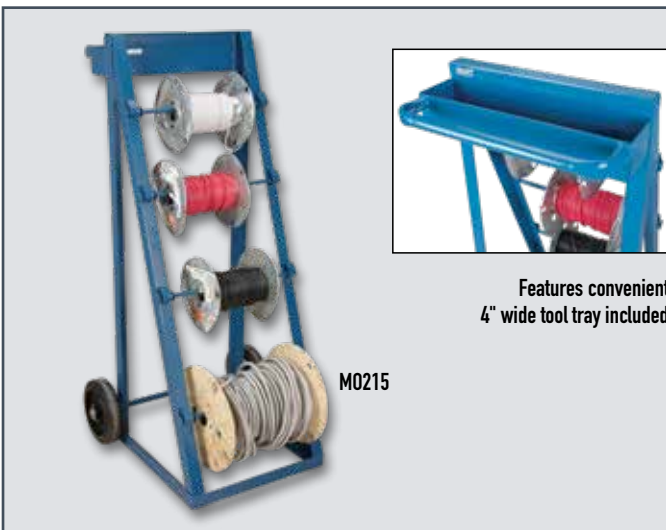

Features convenient 4" wide tool tray included

PORTABLE WIRE REEL CADDY

- Mobile storage for wire spools, reels, and cables
- Ideal for electricians, contractors and builders
- Ready to use, all-welded steel construction
- Rolls on 8" mold-on rubber wheels
- 4 clip-in-place rods for easy spool change
- Holds up to 8" diameter spools on top 3 rods
- Holds up to 12" diameter spools on lower rod
- Durable KLETON blue enamel finish
- Load capacity is based on evenly distributed weight
- Capacity: 400 lbs.
- Cart Material: Steel
- Overall Width: 24-1/2"
- Overall Height: 49"
- Overall Depth: 23"
- Weight: 52 lbs.

Model No. **M0215**



MOBILE WIRE SPOOL CART

- 6 removable spool rods (3 per side)
- Two 18" wide louvered panels on each end
- 5" non-marking blue rubber casters; 2 swivel with brake and 2 rigid
- Extended push handle on the end with the swivel casters
- Durable KLETON blue enamel finish
- Capacity: 1200 lbs.
- Cart Material: Steel
- Overall Width: 21"
- Overall Height: 48"
- Overall Depth: 38"
- Construction: All-Welded
- Rod Quantity: 6

Model No. **MP086**

CASTERS

BLUE ELASTIC RUBBER CASTERS

- High load capacity, rolls easily and quietly on all floors
- Non-marking, excellent floor protection
- Zinc chrome plated finish provides corrosion resistance
- Elastic rubber tread rejects floor debris
- Sealed double ball raceway
- Thread guards
- Ball bearing
- Total locking brake locks the wheel and keeps the swivel from turning

| Model No. | Wheel Dia." | Style | Cap. lbs. | Tread Width" | Overall Height" |
|-----------|-------------|---------------------|-----------|--------------|-----------------|
| MO511* | 3 | Swivel | 285 | 1-1/4 | 4-1/4 |
| MO512* | 3 | Rigid | 285 | 1-1/4 | 4-1/4 |
| MO513* | 3 | Total locking brake | 285 | 1-1/4 | 4-1/4 |
| ML333 | 4 | Swivel | 350 | 1-3/8 | 5 |
| ML334 | 4 | Rigid | 350 | 1-3/8 | 5 |
| ML342 | 4 | Total locking brake | 350 | 1-3/8 | 5 |
| ML337 | 5 | Swivel | 400 | 1-3/8 | 6 |
| ML338 | 5 | Rigid | 400 | 1-3/8 | 6 |
| ML345 | 5 | Total locking brake | 400 | 1-3/8 | 6 |

*Roller Bearing

PLATE SIZE:
3-3/8" x 4"

BOLT HOLE CENTRES:
2-3/8" x 3-1/8"

BOLT HOLE SIZE:
3/8"

RIGID



SWIVEL



TOTAL LOCKING BRAKE



POLYURETHANE CASTERS

- Smooth rolling, low noise operation
- Non-marking, cut & tear resistant
- Die cast aluminum core with brown polyurethane tread
- Resistant to most chemicals, moisture friendly
- Double ball raceway
- Annular ball bearing
- Total locking brake locks the wheel and keeps the swivel from turning
- Butterfly side brake locks the wheel preventing it from rolling

| Model No. | Wheel Dia." | Style | Cap. lbs. | Tread Width" | Overall Height" |
|-----------|-------------|----------------------|-----------|--------------|-----------------|
| ML044 | 3 | Swivel | 230 | 1-1/4 | 4-1/4 |
| ML043 | 3 | Rigid | 230 | 1-1/4 | 4-1/4 |
| ML045 | 4 | Swivel | 440 | 1-1/2 | 5-3/8 |
| ML046 | 4 | Rigid | 440 | 1-1/2 | 5-3/8 |
| ML441 | 4HD | Swivel | 550 | 1-5/8 | 5-5/8 |
| ML442 | 4HD | Rigid | 550 | 1-5/8 | 5-5/8 |
| MN264 | 4HD | Total locking brake | 550 | 1-5/8 | 5-5/8 |
| ML397 | 5 | Swivel | 650 | 1-1/2 | 6-1/2 |
| ML398 | 5 | Rigid | 650 | 1-1/2 | 6-1/2 |
| MN265 | 5 | Total locking brake | 650 | 1-1/2 | 6-1/2 |
| ML399 | 6 | Swivel | 850 | 1-1/2 | 7-1/2 |
| ML400 | 6 | Rigid | 850 | 1-1/2 | 7-1/2 |
| MN266 | 6 | Total locking brake | 850 | 1-1/2 | 7-1/2 |
| MN449 | 6 | Butterfly side brake | 850 | 1-1/2 | 7-1/2 |
| ML401 | 8 | Swivel | 1000 | 1-5/8 | 9-1/2 |
| ML402 | 8 | Rigid | 1000 | 1-5/8 | 9-1/2 |
| MN267 | 8 | Total locking brake | 1000 | 1-5/8 | 9-1/2 |
| MN450 | 8 | Butterfly side brake | 1000 | 1-5/8 | 9-1/2 |

PLATE SIZE:
3 = 2-5/8" x 3-3/4"
4 = 3-1/8" x 4-1/8"
4 HD = 4" x 4-1/2"
5 = 4" x 4-1/2"
6 = 4" x 4-1/2"
8 = 4" x 4-1/2"

BOLT HOLE CENTRES:
3 = 1-3/4" x 2-3/4"
4 = 2-3/8" x 3-1/16"
4 HD = 3-1/4" x 2-3/4"
5 = 3-1/4" x 2-3/4"
6 = 3-1/4" x 2-3/4"
8 = 3-1/4" x 2-3/4"

BOLT HOLE SIZE:
3 = 5/16"
4 = 5/16"
4 HD = 3/8"
5 = 3/8"
6 = 3/8"
8 = 3/8"

RIGID



SWIVEL



TOTAL LOCKING BRAKE



BUTTERFLY SIDE BRAKE



POLYOLEFIN CASTERS

- Rolls easily on most floors
- Lightweight and economical
- Non-marking, easy to maintain, steam cleanable
- High impact strength
- Superior resistance to most oils, chemicals, grease and acids

| Model No. | Wheel Dia." | Style | Cap. lbs. | Tread Width" | Overall Height" |
|-----------|-------------|--------|-----------|--------------|-----------------|
| ML391 | 3 | Swivel | 250 | 1-1/4 | 4-1/2 |
| ML392 | 3 | Rigid | 250 | 1-1/4 | 4-1/2 |
| ML393 | 4 | Swivel | 250 | 1-1/4 | 5-1/4 |
| ML394 | 4 | Rigid | 250 | 1-1/4 | 5-1/4 |
| ML395 | 5 | Swivel | 250 | 1-1/4 | 6-1/8 |
| ML396 | 5 | Rigid | 250 | 1-1/4 | 6-1/8 |

PLATE SIZE: 2-5/8" x 3-3/4"

BOLT HOLE CENTRES: 2-3/4" x 1-3/4"

BOLT HOLE SIZE: 5/16"



HI-TEMP NYLON CASTERS

- Smooth rolling, non-marking
- Zinc chrome plated finish provides corrosion resistance
- Superior resistance to most oils, chemicals, and grease
- Double ball raceway
- Ball bearing
- Total locking brake locks the wheel and keeps the swivel from turning
- Butterfly side brake locks the wheel preventing it from rolling

| Model No. | Wheel Dia." | Style | Cap. lbs. | Tread Width" | Overall Height" |
|-----------|-------------|----------------------|-----------|--------------|-----------------|
| ML861 | 6 | Swivel | 800 | 1-3/4 | 7-5/8 |
| ML862 | 6 | Rigid | 800 | 1-3/4 | 7-5/8 |
| ML863 | 6 | Total locking brake | 800 | 1-3/4 | 7-5/8 |
| MN453 | 6 | Butterfly side brake | 800 | 1-3/4 | 7-5/8 |
| ML864 | 8 | Swivel | 850 | 1-3/4 | 9-1/2 |
| ML865 | 8 | Rigid | 850 | 1-3/4 | 9-1/2 |
| ML866 | 8 | Total locking brake | 850 | 1-3/4 | 9-1/2 |
| MN454 | 8 | Butterfly side brake | 850 | 1-3/4 | 9-1/2 |

PLATE SIZE:

4" x 4-1/2"

BOLT HOLE CENTERS:

3" x 3-1/3"

BOLT HOLE SIZE:

7/16"



CASTERS

MOLD-ON RUBBER CASTERS

- Molded rubber wheel permanently bonded to spoked cast iron core
- Iron centre gives it strength while the molded rubber offers smooth and quiet operation
- Protects loads and surfaces
- Won't damage warehouse or factory floors
- Bearing type: Roller
- Excellent for heavy loads and Industrial equipment

| Model No. | Wheel Dia." | Style | Cap. lbs. | Tread Width" | Bearing Type |
|-----------|-------------|----------------------|-----------|--------------|--------------|
| ML846 | 5 | Swivel | 400 | 2 | Roller |
| ML847 | 5 | Rigid | 400 | 2 | Roller |
| ML849 | 6 | Swivel | 500 | 2 | Roller |
| ML850 | 6 | Rigid | 500 | 2 | Roller |
| ML851 | 6 | Total locking brake | 500 | 2 | Roller |
| MN451 | 6 | Butterfly side brake | 500 | 2 | Roller |
| ML852 | 8 | Swivel | 600 | 2 | Roller |
| ML853 | 8 | Rigid | 600 | 2 | Roller |
| ML854 | 8 | Total locking brake | 600 | 2 | Roller |
| MN452 | 8 | Butterfly side brake | 600 | 2 | Roller |

PLATE SIZE: 4" x 4-1/2"

BOLT HOLE CENTERS: 2-7/8" x 3-1/3"

BOLT HOLE SIZE: 7/16"

| | |
|----------------------|--|
| RIGID |  |
| SWIVEL |  |
| TOTAL LOCKING BRAKE |  |
| BUTTERFLY SIDE BRAKE |  |

PNEUMATIC CASTERS

- Four ply pneumatic casters offer smooth and quiet rolling over the roughest surfaces and outdoor terrain
- Shock absorbing properties give the greatest possible protection to both the load and floor
- The "Air cushion" feature will transport the most fragile material and instruments without damage
- Not recommended for floors with metal shavings or corrosive chemicals

| Model No. | Wheel Dia." | Style | Cap. lbs. | Tread Width" | Overall Height" |
|-----------|-------------|--------|-----------|--------------|-----------------|
| MN222 | 8 | Swivel | 350 | 2 | 10 |
| MN221 | 8 | Rigid | 350 | 2 | 10 |
| MN224 | 10 | Swivel | 400 | 3 | 12 |
| MN223 | 10 | Rigid | 400 | 3 | 12 |

Note: For optimum use pneumatic wheels must be properly inflated

REPLACEMENT PARTS

Model No. **MN372**, Inner tube for **MN221** & **MN222**

Model No. **MN373**, Inner tube for **MN223** & **MN224**

PLATE SIZE: 4" x 4-1/2"

BOLT HOLE CENTERS: 2-3/4" x 3-3/8"

BOLT HOLE SIZE: 13/32"

| | |
|--------|---|
| RIGID |  |
| SWIVEL |  |

NYLON SANDWICH CASTERS

- Non-marking white nylon elastic rubber cushion ring layer reduces noise and vibration
- Ideal for use on concrete, brick, carpet and steel
- Chrome zinc-finish for corrosion resistance
- Double raceway
- Ball bearing
- Total locking brake locks the wheel and keeps the swivel from turning

| Model No. | Wheel Dia." | Style | Cap. lbs. | Tread Width" | Overall Height" |
|-----------|-------------|---------------------|-----------|--------------|-----------------|
| MN441 | 4 | Swivel | 440 | 1-3/8 | 5-1/8 |
| MN442 | 4 | Rigid | 440 | 1-3/8 | 5-1/8 |
| MN443 | 4 | Total locking brake | 440 | 1-3/8 | 5-1/8 |
| MN444 | 5 | Swivel | 440 | 1-3/8 | 6-1/8 |
| MN445 | 5 | Rigid | 440 | 1-3/8 | 6-1/8 |
| MN446 | 5 | Total locking brake | 440 | 1-3/8 | 6-1/8 |

PLATE SIZE: 3 1/3" x 4 1/8"

BOLT HOLE CENTRES: 3 1/8" x 2 1/3"

BOLT HOLE SIZE: 5/16"



FLAT-FREE CASTERS

- Solid polyurethane wheel never runs flat
- Ideal for use on concrete, brick, carpet, steel, tile, asphalt, wood and linoleum
- Same bounce feel and weight of a pneumatic caster
- Smooth and quiet rolling over rough terrain and surfaces
- Less costly than traditional foam-filled tires
- Ball bearing

| Model No. | Wheel Dia." | Style | Cap. lbs. | Tread Width" | Overall Height" |
|-----------|-------------|--------|-----------|--------------|-----------------|
| MN226 | 8 | Swivel | 275 | 2 | 10 |
| MN225 | 8 | Rigid | 275 | 2 | 10 |
| MN228 | 10 | Swivel | 300 | 3 | 12 |
| MN227 | 10 | Rigid | 300 | 3 | 12 |

PLATE SIZE: 4" x 4-1/2"

BOLT HOLE CENTERS: 2-3/4" x 3-3/8"

BOLT HOLE SIZE: 13/32"



SEMI-PNEUMATIC WHEEL

- Soft rubber tread with steel hub and ball bearings for quiet movement
- Excellent for dollies, floor protection, quiet operation, light duty stock trucks
- Wheel Diameter: 10"
- Capacity: 200 lbs.
- Bore Size: 3/4"
- Tread Width: 2-1/2"
- Temperature: -20°F to 130°F
- Durometer: 85 - 90 A scale
- Hub Type: Offset

Model No. **M0888**



DOUBLE SIDED RUBBER CHOCKS

- Fabricated of a tough rubber compound, reinforced for maximum wearability and strength



| Model No. | Type | Approx. Size W" x L" x H" | Wt. lbs. |
|-----------|----------|---------------------------|----------|
| KH600 | Handle | 8 x 9 x 6 | 11 |
| KH601 | Eye Bolt | 8 x 9 x 6 | 11 |

URETHANE WHEEL CHOCK

- Safety orange colour for greater visibility
- Molded-in hole through width of chock for attaching security chain (chain sold separately)
- Overall size: 8" W x 11" L x 8" H
- Weight: 4 lbs.

Model No. **KH897**



LAMINATED RUBBER CHOCK

- Designed to fit curvature of tire for a strong grip
- Extra heavy-duty laminated rubber and steel construction for use with heavy utility trucks and equipment
- Load capacity: Up to 40 000 lbs.
- 8" W x 8" L x 8" H
- Weight: 14 lbs.

Model No. **KH603**



INDUSTRIAL DUTY RUBBER WHEEL CHOCK

- Highly resistant to abrasion, impacts, corrosion, sun, salt, ozone and oil
- Steel ring on back
- 6-1/2" W x 9-1/2" L x 7-1/2" H
- Weight: 12.5 lbs.

Model No. **KH032**



HEAVY-DUTY RUBBER WHEEL CHOCK

- Highly resistant to abrasion, impacts, corrosion, sun, salt, ozone and oil
- Handle on back for easy placement
- 8-5/8" W x 10-5/8" D x 7" H
- Weight: 22 lbs
- 40" max tire diameter

Model No. **KI252**



STANDARD DUTY RUBBER WHEEL CHOCK

- Constructed of reinforced rubber
- Resists tearing, abrasions, impacts, corrosion, sun, salt and oil
- Back handle
- 7-1/8" W x 9-7/8" L x 7-1/2" H
- Weight: 9.5 lbs.

Model No. **KH893**

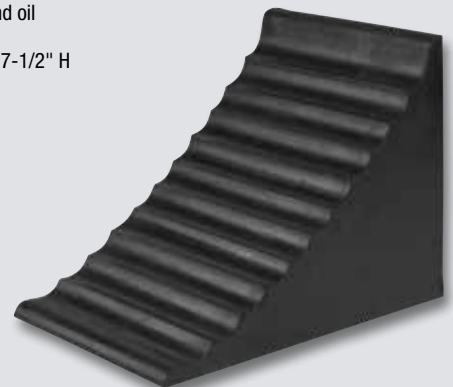

PREVENT ACCIDENTS! Chocks are designed to provide maximum gripping power on almost any surface, wet or dry. They are resistant to sun, moisture, salt, oil and meet OSHA requirements.

VEHICLE SERVICE EQUIPMENT

ICE CHOCK

- Formed steel
- "Tooth" like bottom assures reliable grip
- Lightweight and dependable
- Maximum holding power for snow and ice
- Overall dimensions: 10-1/2" L x 8" W x 9-1/4" H
- Powder-coated safety yellow finish for high visibility
- Weight: 9 lbs.

Model No. **KH964**

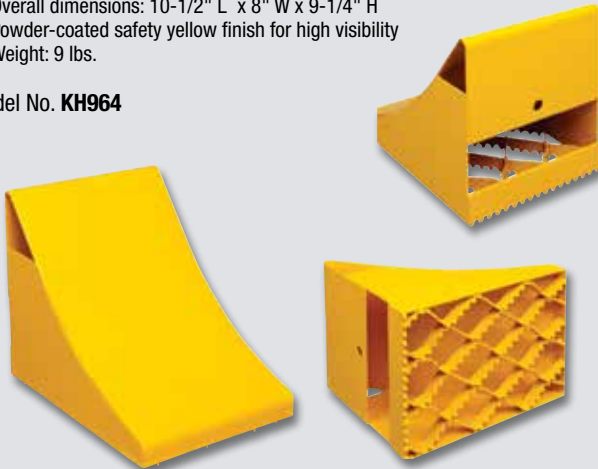

WHEEL CHOCK WALL BRACKET

- Sturdy yellow metal construction
- Fits most sizes of wheel chocks (e.g. **KH032**, **KH603**)
- Prevents loss of chock

Model No. **KH963**



MOLDED DOCK BUMPERS

- Protects building and dock areas
- Shockproof, tear and freeze resistant



| Model No. | Type | Face size W" x H" | Overall Projection" | Wt. lbs. |
|--------------|-------------|-------------------|---------------------|----------|
| KH005 | Rectangular | 13 x 10 | 4 | 16 |
| KH009 | Rectangular | 18 x 10 | 4 | 32 |

TRAILER STABILIZING JACK

- Keeps tractorless trailers leveled while being loaded or unloaded
- Prevents accidents if wheel support collapses
- Stabilizes vehicle against load shifts
- Lowered height: 39-1/2"
- Raised height: 51"
- Removeable 37-1/2" positioning and ratcheting handle
- 8" dia support pad
- 8" wheels
- 100 000 lbs. supporting capacity each and 40 000 lbs. lifting capacity each
- 1 year warranty
- Recommended use in pairs

Model No. **KH777**



CORNER BUMPER

- Protects a wide variety of mobile equipment and the surrounding environment from bumps and scrapes
- Non-marking rubber construction
- Comes equipped with a steel insert and 4 self tapping screws allowing bumper to be mounted on any flat surface
- Thickness: 7/8"
- Dimensions: 4" L x 4" W x 1" H

Model No. **MC043**

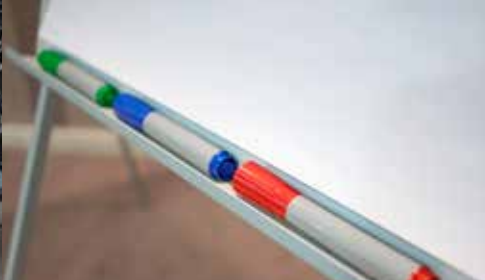

SHOP & INDUSTRIAL FURNITURE

| | | | |
|---------------------------------|-----------|------------------------------|-----------|
| Workbenches | 121 - 135 | Heavy-Duty Workbenches | 139 |
| Workbench Leg & Pedestals | 131 | Folding Tables | 140 - 141 |
| Workbench Tops | 132 | Folding Chairs | 141 |
| Workbench Components | 133 | Folding Benches | 141 |
| Modu-Bench Workbenches | 131 - 135 | Cork Boards | 142 |
| Mobile Workbenches | 136 - 137 | White Boards | 143 |
| Mobile Cabinet Benches | 136 | Step Stools | 142 |
| Mobile Tool Box Benches | 81? | Shop Desks | 144 |
| Cabinet Workbenches | 138 - 139 | Locker Room Benches | 144 |

GET THE PERFECT WORKBENCH FOR YOUR NEEDS

Check out these options,
and then select from one of our
pre-designed models
on pages 122-130.



Top Styles

- Steel - Wood Filled Top
- Laminated Wood
- Shop Top
- Plastic Laminate
- Laminated Wood Top
1-1/4" or 1-3/4"
- Rounded Laminate Top
1-1/4" or 1-3/4"

See Page 132 for details



Leg Types

- Industrial Duty
1000 lb. capacity
- Heavy Duty
2500 lb. capacity

See Page 133 for details



Pedestal Styles

- Full Door
- Two-Door
- Two-Drawer, 1 Door
- Two-Drawer
- Three-Drawer
- Four-Drawer
- Four-Drawer, One door
- Six-Drawer

See Page 131 for details

WORKBENCHES



INDUSTRIAL DUTY - 1000 LBS. CAPACITY, ADJUSTABLE LEGS

| TOPS | 24" x 60" | 30" x 60" | 30" x 72" | 36" x 60" | 36" x 72" |
|------|-----------------------------|-----------|-----------|-----------|-----------|
| | STEEL - WOOD FILL TOP | | | | |
| | FN049 | — | — | FN052 | FN053 |
| | LAMINATED WOOD TOP - 1 3/4" | | | | |
| | FN054 | FN055 | FN056 | FN057 | FN058 |
| | SHOP TOP | | | | |
| | FN059 | FN060 | FN061 | FN062 | FN063 |
| | PLASTIC LAMINATE TOP | | | | |
| | FN064 | FN065 | FN066 | FN067 | FN068 |
| | LAMINATED WOOD TOP - 1 1/4" | | | | |
| | FN269 | FN270 | FN271 | FN272 | FN273 |

HEAVY DUTY - 2500 LBS. CAPACITY

| TOPS | 24" x 60" | 30" x 60" | 30" x 72" | 36" x 60" | 36" x 72" |
|------|---|-----------|-----------|-----------|-----------|
| | STEEL - WOOD FILL TOP | | | | |
| | FF667 | FF669 | FF670 | FF671 | FF672 |
| | LAMINATED WOOD TOP - 1 3/4" | | | | |
| | FF653 | FF655 | FF656 | FF657 | FF658 |
| | SHOP TOP | | | | |
| | FH878 | FF676 | FF677 | FH877 | FF679 |
| | PLASTIC LAMINATE TOP | | | | |
| | FH880 | FF662 | FF663 | FH879 | FF665 |
| | LAMINATED WOOD TOP - 1 1/4" - 1500 LBS CAPACITY | | | | |
| | FM948 | FM949 | FM950 | FM951 | FM952 |

INDUSTRIAL DUTY - 1000 LBS. CAPACITY, ADJUSTABLE LEGS



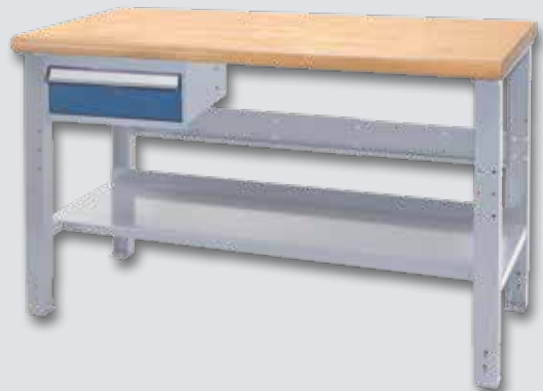

| TOPS | 24" x 60" | 30" x 60" | 30" x 72" | 36" x 60" | 36" x 72" |
|------|-----------------------------|-----------|-----------|-----------|-----------|
| | STEEL - WOOD FILL TOP | | | | |
| | FN089 | — | — | FN092 | FN093 |
| | LAMINATED WOOD TOP - 1 3/4" | | | | |
| | FN094 | FN095 | FN096 | FN097 | FN098 |
| | SHOP TOP | | | | |
| | FN099 | FN100 | FN101 | FN102 | FN103 |
| | PLASTIC LAMINATE TOP | | | | |
| | FN104 | FN105 | FN106 | FN107 | FN108 |
| | LAMINATED WOOD TOP - 1 1/4" | | | | |
| | FN279 | FN280 | FN281 | FN282 | FN283 |

HEAVY DUTY - 2500 LBS. CAPACITY





| TOPS | 24" x 60" | 30" x 60" | 30" x 72" | 36" x 60" | 36" x 72" |
|------|---|-----------|-----------|-----------|-----------|
| | STEEL - WOOD FILL TOP | | | | |
| | FG289 | FG290 | FG291 | FG292 | FG293 |
| | LAMINATED WOOD TOP - 1 3/4" | | | | |
| | FG281 | FG282 | FG283 | FG284 | FG285 |
| | SHOP TOP | | | | |
| | FH886 | FG294 | FG295 | FH885 | FG296 |
| | PLASTIC LAMINATE TOP | | | | |
| | FH888 | FG286 | FG287 | FH887 | FG288 |
| | LAMINATED WOOD TOP - 1 1/4" - 1500 LBS CAPACITY | | | | |
| | FM958 | FM959 | FM960 | FM961 | FM962 |



INDUSTRIAL DUTY - 1000 LBS. CAPACITY, ADJUSTABLE LEGS





| TOPS | 24" x 60" | 30" x 60" | 30" x 72" | 36" x 60" | 36" x 72" |
|---|-----------------------------|-----------|-----------|-----------|-----------|
|  | STEEL - WOOD FILL TOP | | | | |
| | FN069 | — | — | FN072 | FN073 |
|  | LAMINATED WOOD TOP - 1 3/4" | | | | |
| | FN074 | FN075 | FN076 | FN077 | FN078 |
|  | SHOP TOP | | | | |
| | FN079 | FN080 | FN081 | FN082 | FN083 |
|  | PLASTIC LAMINATE TOP | | | | |
| | FN084 | FN085 | FN086 | FN087 | FN088 |
|  | LAMINATED WOOD TOP - 1 1/4" | | | | |
| | FN274 | FN275 | FN276 | FN277 | FN278 |

HEAVY DUTY - 2500 LBS. CAPACITY





| TOPS | 24" x 60" | 30" x 60" | 30" x 72" | 36" x 60" | 36" x 72" |
|--|---|-----------|-----------|-----------|-----------|
|  | STEEL - WOOD FILL TOP | | | | |
| | FF700 | FF702 | FF703 | FF706 | FF707 |
|  | LAMINATED WOOD TOP - 1 3/4" | | | | |
| | FF686 | FF688 | FF689 | FF690 | FF691 |
|  | SHOP TOP | | | | |
| | FH882 | FF712 | FF713 | FH881 | FF715 |
|  | PLASTIC LAMINATE TOP | | | | |
| | FH884 | FF695 | FF696 | FH883 | FF698 |
|  | LAMINATED WOOD TOP - 1 1/4" - 1500 LBS CAPACITY | | | | |
| | FM953 | FM954 | FM955 | FM956 | FM957 |



INDUSTRIAL DUTY - 1000 LBS. CAPACITY, ADJUSTABLE LEGS





| TOPS | 24" x 60" | 30" x 60" | 30" x 72" | 36" x 60" | 36" x 72" |
|---|-----------------------------|-----------|-----------|-----------|-----------|
|  | STEEL - WOOD FILL TOP | | | | |
| | FN109 | — | — | FN112 | FN113 |
|  | LAMINATED WOOD TOP - 1 3/4" | | | | |
| | FN114 | FN115 | FN116 | FN117 | FN118 |
|  | SHOP TOP | | | | |
| | FN119 | FN120 | FN121 | FN122 | FN123 |
|  | PLASTIC LAMINATE TOP | | | | |
| | FN124 | FN125 | FN126 | FN127 | FN128 |
|  | LAMINATED WOOD TOP - 1 1/4" | | | | |
| | FN284 | FN285 | FN286 | FN287 | FN288 |

HEAVY DUTY - 2500 LBS. CAPACITY





| TOPS | 24" x 60" | 30" x 60" | 30" x 72" | 36" x 60" | 36" x 72" |
|---|---|-----------|-----------|-----------|-----------|
|  | STEEL - WOOD FILL TOP | | | | |
| | FG104 | FG106 | FG107 | FG108 | FG109 |
|  | LAMINATED WOOD TOP - 1 3/4" | | | | |
| | FG090 | FG092 | FG093 | FG094 | FG095 |
|  | SHOP TOP | | | | |
| | FH890 | FG113 | FG114 | FH889 | FG116 |
|  | PLASTIC LAMINATE TOP | | | | |
| | FH892 | FG099 | FG100 | FH891 | FG102 |
|  | LAMINATED WOOD TOP - 1 1/4" - 1500 LBS CAPACITY | | | | |
| | FM963 | FM964 | FM965 | FM966 | FM967 |

WORKBENCHES

INDUSTRIAL DUTY - 1000 LBS. CAPACITY, ADJUSTABLE LEGS





| TOPS | 24" x 60" | 30" x 60" | 30" x 72" | 36" x 60" | 36" x 72" |
|---|-----------------------------|-----------|-----------|-----------|-----------|
|  | STEEL - WOOD FILL TOP | | | | |
| | FN129 | — | — | FN132 | FN133 |
|  | LAMINATED WOOD TOP - 1 3/4" | | | | |
| | FN134 | FN135 | FN136 | FN137 | FN138 |
|  | SHOP TOP | | | | |
| | FN139 | FN140 | FN141 | FN142 | FN143 |
|  | PLASTIC LAMINATE TOP | | | | |
| | FN144 | FN145 | FN146 | FN147 | FN148 |
|  | LAMINATED WOOD TOP - 1 1/4" | | | | |
| | FN289 | FN290 | FN291 | FN292 | FN293 |

HEAVY DUTY - 2500 LBS. CAPACITY





| TOPS | 24" x 60" | 30" x 60" | 30" x 72" | 36" x 60" | 36" x 72" |
|---|---|-----------|-----------|-----------|-----------|
|  | STEEL - WOOD FILL TOP | | | | |
| | FG273 | FG274 | FG275 | FG276 | FG277 |
|  | LAMINATED WOOD TOP - 1 3/4" | | | | |
| | FG265 | FG266 | FG267 | FG268 | FG269 |
|  | SHOP TOP | | | | |
| | FH894 | FG278 | FG279 | FH893 | FG280 |
|  | PLASTIC LAMINATE TOP | | | | |
| | FH896 | FG270 | FG271 | FH895 | FG272 |
|  | LAMINATED WOOD TOP - 1 1/4" - 1500 LBS CAPACITY | | | | |
| | FM968 | FM969 | FM970 | FM971 | FM972 |



INDUSTRIAL DUTY - 1000 LBS. CAPACITY, ADJUSTABLE LEGS





| TOPS | 24" x 60" | 30" x 60" | 30" x 72" | 36" x 60" | 36" x 72" |
|---|-----------------------------|-----------|-----------|-----------|-----------|
|  | STEEL - WOOD FILL TOP | | | | |
| | FN149 | — | — | FN152 | FN153 |
|  | LAMINATED WOOD TOP - 1 3/4" | | | | |
| | FN154 | FN155 | FN156 | FN157 | FN158 |
|  | SHOP TOP | | | | |
| | FN159 | FN160 | FN161 | FN162 | FN163 |
|  | PLASTIC LAMINATE TOP | | | | |
| | FN164 | FN165 | FN166 | FN167 | FN168 |
|  | LAMINATED WOOD TOP - 1 1/4" | | | | |
| | FN294 | FN295 | FN296 | FN297 | FN298 |

HEAVY DUTY - 2500 LBS. CAPACITY





| TOPS | 24" x 60" | 30" x 60" | 30" x 72" | 36" x 60" | 36" x 72" |
|---|---|-----------|-----------|-----------|-----------|
|  | STEEL - WOOD FILL TOP | | | | |
| | FG443 | FG444 | FG642 | FG641 | FG640 |
|  | LAMINATED WOOD TOP - 1 3/4" | | | | |
| | FG639 | FG638 | FG637 | FG636 | FG635 |
|  | SHOP TOP | | | | |
| | FH898 | FG647 | FG646 | FH897 | FG645 |
|  | PLASTIC LAMINATE TOP | | | | |
| | FH900 | FG650 | FG649 | FH899 | FG648 |
|  | LAMINATED WOOD TOP - 1 1/4" - 1500 LBS CAPACITY | | | | |
| | FM973 | FM974 | FM975 | FM976 | FM977 |



INDUSTRIAL DUTY - 1000 LBS. CAPACITY, ADJUSTABLE LEGS





| TOPS | 24" x 60" | 30" x 60" | 30" x 72" | 36" x 60" | 36" x 72" |
|---|-----------------------------|-----------|-----------|-----------|-----------|
|  | STEEL - WOOD FILL TOP | | | | |
| | FN173 | — | — | FN170 | FN169 |
|  | LAMINATED WOOD TOP - 1 3/4" | | | | |
| | FN178 | FN177 | FN176 | FN175 | FN174 |
|  | SHOP TOP | | | | |
| | FN183 | FN182 | FN181 | FN180 | FN179 |
|  | PLASTIC LAMINATE TOP | | | | |
| | FN188 | FN187 | FN186 | FN185 | FN184 |
|  | LAMINATED WOOD TOP - 1 1/4" | | | | |
| | FN333 | FN332 | FN331 | FN330 | FN329 |

HEAVY DUTY - 2500 LBS. CAPACITY





| TOPS | 24" x 60" | 30" x 60" | 30" x 72" | 36" x 60" | 36" x 72" |
|---|---|-----------|-----------|-----------|-----------|
|  | STEEL - WOOD FILL TOP | | | | |
| | FI556 | FI555 | FI554 | FI553 | FI552 |
|  | LAMINATED WOOD TOP - 1 3/4" | | | | |
| | FI561 | FI560 | FI559 | FI558 | FI557 |
|  | SHOP TOP | | | | |
| | FI566 | FI565 | FI564 | FI563 | FI562 |
|  | PLASTIC LAMINATE TOP | | | | |
| | FI571 | FI570 | FI569 | FI568 | FI567 |
|  | LAMINATED WOOD TOP - 1 1/4" - 1500 LBS CAPACITY | | | | |
| | FN013 | FN012 | FN011 | FN010 | FN009 |



INDUSTRIAL DUTY - 1000 LBS. CAPACITY, ADJUSTABLE LEGS

| TOPS | 24" x 60" | 30" x 60" | 30" x 72" | 36" x 60" | 36" x 72" |
|---|-----------------------------|-----------|-----------|-----------|-----------|
|  | STEEL - WOOD FILL TOP | | | | |
| | FN193 | — | — | FN190 | FN189 |
|  | LAMINATED WOOD TOP - 1 3/4" | | | | |
| | FN198 | FN197 | FN196 | FN195 | FN194 |
|  | SHOP TOP | | | | |
| | FN203 | FN202 | FN201 | FN200 | FN199 |
|  | PLASTIC LAMINATE TOP | | | | |
| | FN208 | FN207 | FN206 | FN205 | FN204 |
|  | LAMINATED WOOD TOP - 1 1/4" | | | | |
| | FN338 | FN337 | FN336 | FN335 | FN334 |

HEAVY DUTY - 2500 LBS. CAPACITY





| TOPS | 24" x 60" | 30" x 60" | 30" x 72" | 36" x 60" | 36" x 72" |
|---|---|-----------|-----------|-----------|-----------|
|  | STEEL - WOOD FILL TOP | | | | |
| | FI576 | FI575 | FI574 | FI573 | FI572 |
|  | LAMINATED WOOD TOP - 1 3/4" | | | | |
| | FI581 | FI580 | FI579 | FI578 | FI577 |
|  | SHOP TOP | | | | |
| | FI586 | FI585 | FI584 | FI583 | FI582 |
|  | PLASTIC LAMINATE TOP | | | | |
| | FI591 | FI590 | FI589 | FI588 | FI587 |
|  | LAMINATED WOOD TOP - 1 1/4" - 1500 LBS CAPACITY | | | | |
| | FN018 | FN017 | FN016 | FN015 | FN014 |







WORKBENCHES







INDUSTRIAL DUTY - 1000 LBS. CAPACITY, ADJUSTABLE LEGS

| TOPS | 24" x 60" | 30" x 60" | 30" x 72" | 36" x 60" | 36" x 72" |
|---|-----------------------------|-----------|-----------|-----------|-----------|
|  | STEEL - WOOD FILL TOP | | | | |
| FN213 | — | — | — | FN210 | FN209 |
|  | LAMINATED WOOD TOP - 1 3/4" | | | | |
| FN218 | FN217 | FN216 | FN216 | FN215 | FN214 |
|  | SHOP TOP | | | | |
| FN223 | FN222 | FN221 | FN221 | FN220 | FN219 |
|  | PLASTIC LAMINATE TOP | | | | |
| FN228 | FN227 | FN226 | FN226 | FN225 | FN224 |
|  | LAMINATED WOOD TOP - 1 1/4" | | | | |
| FN343 | FN342 | FN341 | FN341 | FN340 | FN339 |





HEAVY DUTY - 2500 LBS. CAPACITY

| TOPS | 24" x 60" | 30" x 60" | 30" x 72" | 36" x 60" | 36" x 72" |
|--|---|-----------|-----------|-----------|-----------|
|  | STEEL - WOOD FILL TOP | | | | |
| FI596 | FI595 | FI594 | FI594 | FI593 | FI592 |
|  | LAMINATED WOOD TOP - 1 3/4" | | | | |
| FI601 | FI600 | FI599 | FI599 | FI598 | FI597 |
|  | SHOP TOP | | | | |
| FI606 | FI605 | FI604 | FI604 | FI603 | FI602 |
|  | PLASTIC LAMINATE TOP | | | | |
| FI611 | FI610 | FI609 | FI609 | FI608 | FI607 |
|  | LAMINATED WOOD TOP - 1 1/4" - 1500 LBS CAPACITY | | | | |
| FN023 | FN022 | FN021 | FN021 | FN020 | FN019 |

INDUSTRIAL DUTY - 1000 LBS. CAPACITY, ADJUSTABLE LEGS





| TOPS | 24" x 60" | 30" x 60" | 30" x 72" | 36" x 60" | 36" x 72" |
|---|-----------------------------|-----------|-----------|-----------|-----------|
|  | STEEL - WOOD FILL TOP | | | | |
| FN233 | — | — | — | FN230 | FN229 |
|  | LAMINATED WOOD TOP - 1 3/4" | | | | |
| FN238 | FN237 | FN236 | FN236 | FN235 | FN234 |
|  | SHOP TOP | | | | |
| FN243 | FN242 | FN241 | FN241 | FN240 | FN239 |
|  | PLASTIC LAMINATE TOP | | | | |
| FN248 | FN247 | FN246 | FN246 | FN245 | FN244 |
|  | LAMINATED WOOD TOP - 1 1/4" | | | | |
| FN348 | FN347 | FN346 | FN346 | FN345 | FN344 |

HEAVY DUTY - 2500 LBS. CAPACITY





| TOPS | 24" x 60" | 30" x 60" | 30" x 72" | 36" x 60" | 36" x 72" |
|---|---|-----------|-----------|-----------|-----------|
|  | STEEL - WOOD FILL TOP | | | | |
| FI616 | FI615 | FI614 | FI614 | FI613 | FI612 |
|  | LAMINATED WOOD TOP - 1 3/4" | | | | |
| FI621 | FI620 | FI619 | FI619 | FI618 | FI617 |
|  | SHOP TOP | | | | |
| FI626 | FI625 | FI624 | FI624 | FI623 | FI622 |
|  | PLASTIC LAMINATE TOP | | | | |
| FI631 | FI630 | FI629 | FI629 | FI628 | FI627 |
|  | LAMINATED WOOD TOP - 1 1/4" - 1500 LBS CAPACITY | | | | |
| FN028 | FN027 | FN026 | FN026 | FN025 | FN024 |



INDUSTRIAL DUTY - 1000 LBS. CAPACITY, ADJUSTABLE LEGS

| TOPS | 24" x 60" | 30" x 60" | 30" x 72" | 36" x 60" | 36" x 72" |
|---|-----------------------------|-----------|-----------|-----------|-----------|
|  | STEEL - WOOD FILL TOP | | | | |
| | FN253 | — | — | FN250 | FN249 |
|  | LAMINATED WOOD TOP - 1 3/4" | | | | |
| | FN258 | FN257 | FN256 | FN255 | FN254 |
|  | SHOP TOP | | | | |
| | FN263 | FN262 | FN261 | FN260 | FN259 |
|  | PLASTIC LAMINATE TOP | | | | |
| | FN268 | FN267 | FN266 | FN265 | FN264 |
|  | LAMINATED WOOD TOP - 1 1/4" | | | | |
| | FN353 | FN352 | FN351 | FN350 | FN349 |





HEAVY DUTY - 2500 LBS. CAPACITY

| TOPS | 24" x 60" | 30" x 60" | 30" x 72" | 36" x 60" | 36" x 72" |
|---|---|-----------|-----------|-----------|-----------|
|  | STEEL - WOOD FILL TOP | | | | |
| | FI636 | FI635 | FI634 | FI633 | FI632 |
|  | LAMINATED WOOD TOP - 1 3/4" | | | | |
| | FI641 | FI640 | FI639 | FI638 | FI637 |
|  | SHOP TOP | | | | |
| | FI646 | FI645 | FI644 | FI643 | FI642 |
|  | PLASTIC LAMINATE TOP | | | | |
| | FI651 | FI650 | FI649 | FI648 | FI647 |
|  | LAMINATED WOOD TOP - 1 1/4" - 1500 LBS CAPACITY | | | | |
| | FN033 | FN032 | FN031 | FN030 | FN029 |







WORKBENCHES

HEAVY DUTY - 2500 LBS. CAPACITY

| TOPS | 24" x 60" | 30" x 60" | 30" x 72" | 36" x 60" | 36" x 72" |
|---|---|-----------|-----------|-----------|-----------|
|  | STEEL - WOOD FILL TOP | | | | |
| | F1656 | F1655 | F1654 | F1653 | F1652 |
|  | LAMINATED WOOD TOP - 1 3/4" | | | | |
| | F1661 | F1660 | F1659 | F1658 | F1657 |
|  | SHOP TOP | | | | |
| | F1666 | F1665 | F1664 | F1663 | F1662 |
|  | PLASTIC LAMINATE TOP | | | | |
| | F1671 | F1670 | F1669 | F1668 | F1667 |
|  | LAMINATED WOOD TOP - 1 1/4" - 1500 LBS CAPACITY | | | | |
| | FN038 | FN037 | FN036 | FN035 | FN034 |







HEAVY DUTY - 2500 LBS. CAPACITY

| TOPS | 24" x 60" | 30" x 60" | 30" x 72" | 36" x 60" | 36" x 72" |
|---|---|-----------|-----------|-----------|-----------|
|  | STEEL - WOOD FILL TOP | | | | |
| | F1676 | F1675 | F1674 | F1673 | F1672 |
|  | LAMINATED WOOD TOP - 1 3/4" | | | | |
| | F1681 | F1680 | F1679 | F1678 | F1677 |
|  | SHOP TOP | | | | |
| | F1686 | F1685 | F1684 | F1683 | F1682 |
|  | PLASTIC LAMINATE TOP | | | | |
| | F1691 | F1690 | F1689 | F1688 | F1687 |
|  | LAMINATED WOOD TOP - 1 1/4" - 1500 LBS CAPACITY | | | | |
| | FN043 | FN042 | FN041 | FN040 | FN039 |







HEAVY DUTY - 2500 LBS. CAPACITY

| TOPS | 24" x 60" | 30" x 60" | 30" x 72" | 36" x 60" | 36" x 72" |
|---|---|-----------|-----------|-----------|-----------|
|  | STEEL - WOOD FILL TOP | | | | |
| | F1696 | F1695 | F1694 | F1693 | F1692 |
|  | LAMINATED WOOD TOP - 1 3/4" | | | | |
| | F1701 | F1700 | F1699 | F1698 | F1697 |
|  | SHOP TOP | | | | |
| | F1706 | F1705 | F1704 | F1703 | F1702 |
|  | PLASTIC LAMINATE TOP | | | | |
| | F1711 | F1710 | F1709 | F1708 | F1707 |
|  | LAMINATED WOOD TOP - 1 1/4" - 1500 LBS CAPACITY | | | | |
| | FN048 | FN047 | FN046 | FN045 | FN044 |







HEAVY DUTY - 2500 LBS. CAPACITY

| TOPS | 24" x 60" | 30" x 60" | 30" x 72" | 36" x 60" | 36" x 72" |
|---|---|-----------|-----------|-----------|-----------|
|  | STEEL - WOOD FILL TOP | | | | |
| | FG137 | FG136 | FG135 | FG134 | FG137 |
|  | LAMINATED WOOD TOP - 1 3/4" | | | | |
| | FG123 | FG122 | FG121 | FG120 | FG118 |
|  | SHOP TOP | | | | |
| | FG144 | FH901 | FG142 | FG141 | FH902 |
|  | PLASTIC LAMINATE TOP | | | | |
| | FG130 | FH903 | FG128 | FG127 | FH904 |
|  | LAMINATED WOOD TOP - 1 1/4" - 1500 LBS CAPACITY | | | | |
| | FM982 | FM981 | FM980 | FM979 | FM978 |







HEAVY DUTY - 2500 LBS. CAPACITY

| TOPS | 24" x 60" | 30" x 60" | 30" x 72" | 36" x 60" | 36" x 72" |
|---|---|-----------|-----------|-----------|-----------|
|  | STEEL - WOOD FILL TOP | | | | |
| | FG241 | FG242 | FG243 | FG244 | FG245 |
|  | LAMINATED WOOD TOP - 1 3/4" | | | | |
| | FG233 | FG234 | FG235 | FG236 | FG237 |
|  | SHOP TOP | | | | |
| | FH906 | FG246 | FG247 | FG248 | FG249 |
|  | PLASTIC LAMINATE TOP | | | | |
| | FH908 | FG238 | FG239 | FH907 | FG240 |
|  | LAMINATED WOOD TOP - 1 1/4" - 1500 LBS CAPACITY | | | | |
| | FM983 | FM984 | FM985 | FM986 | FM987 |







HEAVY DUTY - 2500 LBS. CAPACITY

| TOPS | 24" x 60" | 30" x 60" | 30" x 72" | 36" x 60" | 36" x 72" |
|---|---|-----------|-----------|-----------|-----------|
|  | STEEL - WOOD FILL TOP | | | | |
| | FG468 | FG467 | FG466 | FG465 | FG464 |
|  | LAMINATED WOOD TOP - 1 3/4" | | | | |
| | FG463 | FG462 | FG461 | FG460 | FG459 |
|  | SHOP TOP | | | | |
| | FH914 | FG471 | FG470 | FH913 | FG469 |
|  | PLASTIC LAMINATE TOP | | | | |
| | FH916 | FG474 | FG473 | FH915 | FG472 |
|  | LAMINATED WOOD TOP - 1 1/4" - 1500 LBS CAPACITY | | | | |
| | FM997 | FM996 | FM995 | FM994 | FM993 |







WORKBENCHES

HEAVY DUTY - 2500 LBS. CAPACITY

| TOPS | 24" x 60" | 30" x 60" | 30" x 72" | 36" x 60" | 36" x 72" |
|---|---|-----------|-----------|-----------|-----------|
|  | STEEL - WOOD FILL TOP | | | | |
| | FG628 | FG627 | FG626 | FG625 | FG624 |
|  | LAMINATED WOOD TOP - 1 3/4" | | | | |
| | FG623 | FG622 | FG621 | FG620 | FG619 |
|  | SHOP TOP | | | | |
| | FH910 | FG631 | FG630 | FH909 | FG629 |
|  | PLASTIC LAMINATE TOP | | | | |
| | FH912 | FG634 | FG633 | FH911 | FG632 |
|  | LAMINATED WOOD TOP - 1 1/4" - 1500 LBS CAPACITY | | | | |
| | FM992 | FM991 | FM990 | FM989 | FM988 |







HEAVY DUTY - 2500 LBS. CAPACITY

| TOPS | 24" x 60" | 30" x 60" | 30" x 72" | 36" x 60" | 36" x 72" |
|---|---|-----------|-----------|-----------|-----------|
|  | STEEL - WOOD FILL TOP | | | | |
| | FG225 | FG226 | FG227 | FG228 | FG229 |
|  | LAMINATED WOOD TOP - 1 3/4" | | | | |
| | FG217 | FG218 | FG219 | FG220 | FG221 |
|  | SHOP TOP | | | | |
| | FH918 | FG230 | FG231 | FH917 | FG232 |
|  | PLASTIC LAMINATE TOP | | | | |
| | FH920 | FG222 | FG223 | FH919 | FG224 |
|  | LAMINATED WOOD TOP - 1 1/4" - 1500 LBS CAPACITY | | | | |
| | FM998 | FM999 | FN001 | FN002 | FN003 |



HEAVY DUTY - 2500 LBS. CAPACITY

| TOPS | 24" x 60" | 30" x 60" | 30" x 72" | 36" x 60" | 36" x 72" |
|---|---|-----------|-----------|-----------|-----------|
|  | STEEL - WOOD FILL TOP | | | | |
| | FG411 | FG412 | FG413 | FG414 | FG415 |
|  | LAMINATED WOOD TOP - 1 3/4" | | | | |
| | FG416 | FG417 | FG418 | FG419 | FG420 |
|  | SHOP TOP | | | | |
| | FH922 | FG421 | FG422 | FH921 | FG423 |
|  | PLASTIC LAMINATE TOP | | | | |
| | FH924 | FG424 | FG425 | FH923 | FG426 |
|  | LAMINATED WOOD TOP - 1 1/4" - 1500 LBS CAPACITY | | | | |
| | FN004 | FN005 | FN006 | FN007 | FN008 |



CUSTOMIZE YOUR OWN WORKBENCH.
SIMPLY SELECT ANY TWO CABINETS THEN
ADD A TOP FROM THE FOLLOWING PAGE.

MODU-BENCH WORKBENCHES

PEDESTAL STYLES

- All-welded heavy-gauge steel
- 100% full extension drawers with ball bearing slide mechanism
- Reversible doors, can be opened on either left or right side (factory installed hinges on right side)
- Aluminum extrusion handles with grey end caps
- Complete with locks and two keys
- All locks keyed alike for pedestal model
- Custom key options available
- 18" W x 21" D x 28" H, overall cabinet size
- 30" overall height with top
- Optional bases add height in 4" increments (maximum two bases per pedestal)
- Capacity: 100 lbs. per drawer evenly distributed
- Powder coat finish with grey KLETON shell and KLETON blue on doors and drawers



FULL DOOR
16-3/4" W x 21" D x 24" H
Internal Adjustable
Shelf included
Weight: 50 lbs.
Model No. **FH666**



TWO DOORS
(2) 16-3/4" W x 21" D x 12" H
Weight: 48 lbs.
Model No. **FH667**

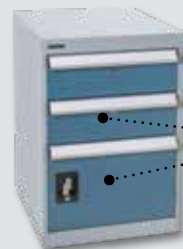

**TWO DRAWERS
& ONE DOOR**
(2) 15-3/8" W x 20" D x 5-5/8" H
(1) 16-3/4" W x 21" D x 12" H
Weight: 70 lbs.
Model No. **FH668**



TWO DRAWERS
(2) 15-3/8" W x 20" D x 11-5/8" H
Weight: 66 lbs.
Model No. **FI166**



THREE DRAWERS
(2) 15-3/8" W x 20" D x 5-5/8" H
(1) 15-3/8" W x 20" D x 11-5/8" H
Weight: 78 lbs.
Model No. **FI167**



FOUR DRAWERS
(4) 15-3/8" W x 20" D x 5-5/8" H
Weight: 68 lbs.
Model No. **FH669**



**FOUR DRAWERS
& ONE DOOR**
(4) 15-3/8" W x 20" D x 2-5/8" H
(1) 16-3/4" W x 21" D x 12" H
Weight: 86 lbs.
Model No. **FH670**

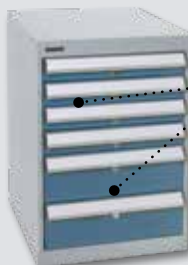

SIX DRAWERS
(4) 15-3/8" W x 20" D x 2-5/8" H
(2) 15-3/8" W x 20" D x 5-5/8" H
Weight: 94 lbs.
Model No. **FH671**

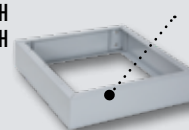

BASE
4" High - 34" high with top
Weight: 8 lbs.
Model No. **FH672**

LEG AND PEDESTAL COMBINATIONS

- All-welded 14-gauge steel legs
- Knockout for standard two-outlet electrical plug
- Overall height of 34" with top
- Powder coat KLETON grey finish

| Model No. | Description | Dimensions D" x H" | Wt. lbs. |
|-----------|---|--------------------|----------|
| ML264 | Single Leg for Use w/ 24"D Top | 22 x 32 | 14 |
| ML265 | Single Leg for Use w/ 30"D or 36" D Top | 28 x 32 | 15 |
| FH672 | Pedestal Base (Max 1)* | 4" H | 8 |
| FF920 | Bench Leg Gussets (Pkg. of 2)* | - | 3 |
| M0931 | Single leg for use w/ 24"D top | | 14 |
| M0932 | Single leg for use w/ 30"D or 36"D top | | 16 |

* Pedestal base and bench leg gussets are required components when building all leg/pedestal combinations

HOW TO ORDER

1. Choose the pedestal and leg combination desired
 2. Choose your desired top
- See our selection of workbench tops on Page 132.

We try to make it easy . . .
look at our pre-designed layout
options on pages 122-130.

Customize to your specifications. If you need specific sizes
or requirements not available on this page . . . call your
KLETON dealer with your specs today!





LAMINATED HARDWOOD TOPS - SQUARE EDGE

- Lacquer finished tops for durability
- Heavy-duty solid hardwood laminations for long life
- Overall thickness: 1-3/4"
- 1/8" radius edge
- Tops over 36" deep are shipped in two pieces

| Model No. | Dimensions D" x W" | Wt. lbs. | Model No. | Dimensions D" x W" | Wt. lbs. |
|-----------|--------------------|----------|-----------|--------------------|----------|
| FI730 | 24 x 48 | 48 | FL596 | 36 x 48 | 72 |
| FL592 | 24 x 60 | 64 | FL597 | 36 x 60 | 92 |
| FI593 | 24 x 72 | 76 | FI738 | 36 x 72 | 107 |
| FI731 | 24 x 84 | 85 | FL598 | 36 x 84 | 124 |
| FL594 | 24 x 96 | 90 | FI739 | 36 x 96 | 144 |
| FI732 | 24 x 120 | 125 | FL599 | 36 x 120 | 154 |
| FI595 | 30 x 48 | 60 | FI740 | 48 x 48 | 99 |
| FI733 | 30 x 60 | 75 | FL600 | 48 x 60 | 120 |
| FI734 | 30 x 72 | 85 | FL601 | 48 x 72 | 138 |
| FI735 | 30 x 84 | 101 | FL602 | 48 x 84 | 163 |
| FI736 | 30 x 96 | 119 | FL603 | 48 x 96 | 183 |
| FI737 | 30 x 120 | 191 | FL604 | 48 x 120 | 240 |



LAMINATED HARDWOOD TOPS - BULLNOSE EDGE

- 3/8" radius edge
- Lacquer finished tops for durability
- Heavy-duty solid hardwood laminations for long life
- Overall thickness: 1-3/4"
- Tops over 36" deep are shipped in two pieces.

| Model No. | Dimensions D" x W" | Wt. lbs. | Model No. | Dimensions D" x W" | Wt. lbs. |
|-----------|--------------------|----------|-----------|--------------------|----------|
| FI522 | 24 x 48 | 47 | FL607 | 36 x 48 | 71 |
| FI523 | 24 x 60 | 58 | FI532 | 36 x 60 | 110 |
| FI524 | 24 x 72 | 69 | FI533 | 36 x 72 | 118 |
| FL605 | 24 x 84 | 81 | FL608 | 36 x 84 | 125 |
| FI525 | 24 x 96 | 92 | FI534 | 36 x 96 | 144 |
| FI526 | 24 x 120 | 117 | FL609 | 36 x 120 | 177 |
| FI527 | 30 x 48 | 60 | FL610 | 48 x 48 | 94 |
| FI528 | 30 x 60 | 73 | FL611 | 48 x 60 | 119 |
| FI529 | 30 x 72 | 90 | FL612 | 48 x 72 | 139 |
| FI530 | 30 x 84 | 100 | FL613 | 48 x 84 | 164 |
| FI531 | 30 x 96 | 120 | FL614 | 48 x 96 | 185 |
| FL606 | 30 x 120 | 155 | FL615 | 48 x 120 | 243 |



THIN LAMINATED HARDWOOD TOPS - BULLNOSE EDGE

- Lacquer finished tops for durability
- Industrial-duty solid hardwood laminations for long life
- Overall thickness: 1-1/4"
- 1/8" radius edge
- Tops over 36" deep are shipped in two pieces

BULL NOSE EDGE

| Model No. | Dimensions D" x W" | Wt. lbs. |
|-----------|--------------------|----------|
| FM930 | 24 x 48 | 35 |
| FM931 | 24 x 60 | 44 |
| FM932 | 24 x 72 | 54 |
| FM933 | 30 x 48 | 43 |
| FM934 | 30 x 60 | 55 |
| FM935 | 30 x 72 | 67 |
| FN369 | 36 x 60 | 70 |
| FM936 | 36 x 72 | 77 |

SQUARE EDGE

| Model No. | Dimensions D" x W" | Wt. lbs. |
|-----------|--------------------|----------|
| FM937 | 24 x 48 | 35 |
| FM938 | 24 x 60 | 41 |
| FM939 | 24 x 72 | 54 |
| FM940 | 30 x 48 | 45 |
| FM941 | 30 x 60 | 55 |
| FM942 | 30 x 72 | 67 |
| FN370 | 36 x 60 | 65 |
| FM943 | 36 x 72 | 80 |

SHOP TOPS

- Great top for medium-duty applications
- 1/2" double sealed resin boards laminated over 3/4" MDF core
- Overall thickness: 1-3/4"



| Model No. | Dimensions D" x W" | Wt. lbs. |
|-----------|--------------------|----------|
| FD001 | 24 x 48 | 60 |
| FD002 | 24 x 60 | 70 |
| FH764 | 30 x 48 | 75 |
| FD004 | 30 x 60 | 88 |
| FD005 | 30 x 72 | 105 |
| FH765 | 30 x 84 | 148 |
| FH766 | 30 x 96 | 160 |
| FH767 | 36 x 48 | 90 |
| FD006 | 36 x 60 | 94 |
| FD007 | 36 x 72 | 126 |
| FH768 | 36 x 84 | 158 |
| FH769 | 36 x 96 | 180 |

PLASTIC LAMINATE TOPS

- Light-duty top with smooth white plastic laminate face covering 45-lb. density particle board
- Overall thickness: 1-5/8"
- Colour: White



| Model No. | Dimensions D" x W" | Wt. lbs. |
|-----------|--------------------|----------|
| FD008 | 24 x 48 | 56 |
| FD009 | 24 x 60 | 66 |
| FH771 | 30 x 48 | 63 |
| FD011 | 30 x 60 | 88 |
| FD012 | 30 x 72 | 105 |
| FH772 | 30 x 84 | 114 |
| FH773 | 30 x 96 | 144 |
| FH774 | 36 x 48 | 87 |
| FD013 | 36 x 60 | 102 |
| FD014 | 36 x 72 | 126 |
| FH776 | 36 x 84 | 151 |
| FH777 | 36 x 96 | 173 |

STEEL WOOD-FILLED TOPS

- Heavy-duty 14-gauge steel with formed edges
- Reinforced with wood core for sound reduction and added strength
- Overall thickness: 1-3/4"
- Colour: Powder coat KLETON grey



| Model No. | Dimensions D" x W" | Wt. lbs. |
|-----------|--------------------|----------|
| FD030 | 24 x 48 | 59 |
| FD031 | 24 x 60 | 74 |
| FH871 | 30 x 48 | 70 |
| FD033 | 30 x 60 | 101 |
| FD034 | 30 x 72 | 110 |
| FH872 | 30 x 84 | 118 |
| FH873 | 30 x 96 | 140 |
| FH874 | 36 x 48 | 88 |
| FD035 | 36 x 60 | 111 |
| FD036 | 36 x 72 | 119 |
| FH875 | 36 x 84 | 148 |
| FH876 | 36 x 96 | 174 |

304 STAINLESS STEEL WOODFILLED TOPS

- Heavy-duty 14-gauge stainless steel with a number 4 finish and formed edges
- Reinforced with wood core for sound reduction and added strength
- Overall thickness: 1-3/4"

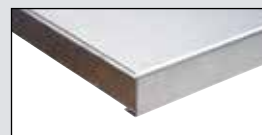

| Model No. | Dimensions D" x W" | Wt. lbs. |
|-----------|--------------------|----------|
| FI268* | 24 x 48 | 64 |
| FI269* | 24 x 60 | 70 |
| FI270* | 30 x 48 | 72 |
| FI271* | 30 x 60 | 92 |
| FI272* | 30 x 72 | 112 |
| FI273* | 30 x 84 | 129 |
| FI274* | 30 x 96 | 143 |
| FI275* | 36 x 48 | 87 |
| FI276* | 36 x 60 | 110 |
| FI277* | 36 x 72 | 132 |
| FI278* | 36 x 84 | 154 |
| FI279* | 36 x 96 | 169 |

* Stainless Steel finish may vary

CREATE A WORKBENCH DESIGNED FOR YOUR APPLICATION

- Select from the components below to build the workbench to fit your needs.
- All components required to make up your workbench are on this page
- Optional features for enhanced functionality are on the following page
- All steel components constructed of 14-gauge steel unless otherwise specified
- All mounting hardware included
- Capacities range from 1000 lbs. to 2500 lbs.
- All steel components are powder coat KLETON grey
- Shipped knocked down

THINGS TO CONSIDER WHEN ORDERING A WORKBENCH

1. Determine the size (length, width, height) of the workbench required.
2. Select one of each of the required components listed on this page, respecting the determined size of the workbench.

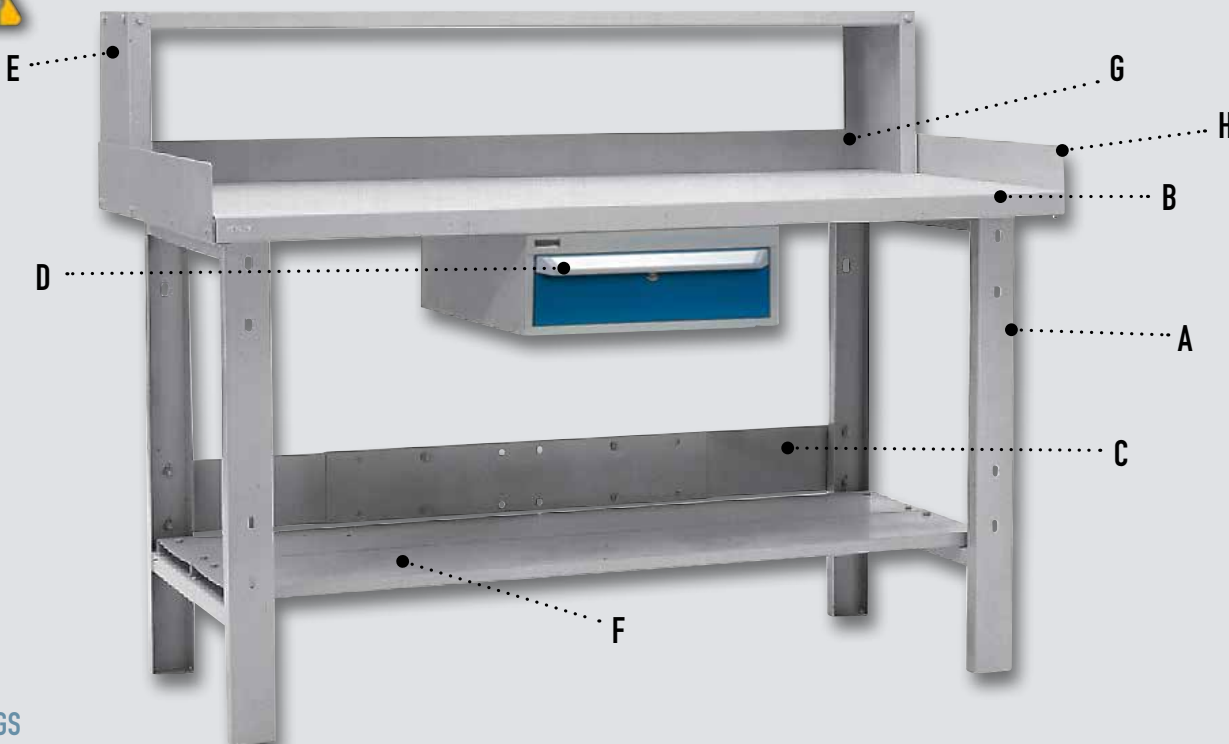

A - LEGS

- Legs static or mobile
- Comes with knockout for standard 2-outlet electrical plug
- Provides an overall height of 34" w/top

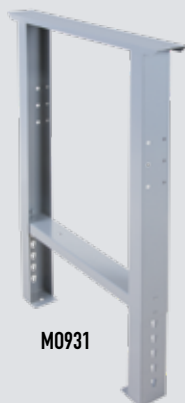

| Model No. | Description | D" x H" | Wt. lbs. |
|---|---|---------|----------|
| HEAVY-DUTY | | | |
| ML264 | Single leg for use w/ 24"D top | 22 x 32 | 14 |
| ML265 | Single leg for use w/ 30"D or 36"D top | 28 x 32 | 15 |
| ML266* | Pair of legs to use w/24"D tops, includes Stringer FF979 | 22 x 32 | 38 |
| ML268* | Pair of legs to use w/30"D or 36"D tops, includes Stringer FF979 | 22 x 32 | 40 |
| ML267* | Mobile Kit for use w/24"D top (pair), includes Stringer FF979 | 28 x 32 | 45 |
| ML269* | Mobile Kit for use w/30"D or 36"D top (pair), includes Stringer FF979 | 28 x 32 | 40 |
| FG732 | Leg extensions to make height adjustable from 34"-39" in 1" increments (set of 4) | | 8 |
| * For 84"L and 96"L tops, FH925 or FH926 stringers are required | | | |
| INDUSTRIAL DUTY | | | |
| M0931 | Single leg for use w/ 24"D top | | 8 |
| M0932 | Single leg for use w/ 30"D or 36"D top | | 8 |

B - TOPS

A variety of tops are available. 14-gauge steel wood filled, laminated wood, Shop Top and plastic laminate in a variety of sizes. Our complete list of tops can be found on Page 132.

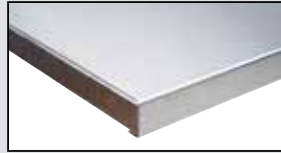

Stainless-Steel Wood-Filled Top



Wood Top



Bullnose- Wood Top



Thin Wood Top



Plastic Laminate Top



Shop Top

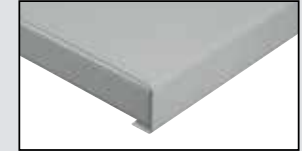

Steel Wood-Filled Top

C - STRINGERS

- Adds stability to the workbench
- Prevents legs from shifting
- Included in kits **ML266** to **ML269**
- Weight: 10lbs.



FF979



M0936

HEAVY-DUTY UNIVERSAL STRINGERS

Model No. **FF979** - for 48", 60" or 72" bench

Model No. **FH925** - for 84" bench

Model No. **FH926** - for 96" bench

INDUSTRIAL DUTY UNIVERSAL STRINGER

Model No. **M0936** - for 48", 60" or 72" bench

D - DRAWERS

- All-welded heavy-gauge steel
- Add storage to any workbench
- 100% full extension with ball bearing slide mechanism
- Equipped with locks and two keys
- All locks keyed alike by drawer model
- Custom key options available
- Capacity: 100 lbs. per drawer evenly distributed
- Aluminum extrusion handles with grey end caps
- Overall Dimensions: 18" W x 21" D x 9" H



SINGLE DRAWER UNITS

Model **FH673**

(1) 15-3/8" W x 20" D x 5-5/8" H



DOUBLE DRAWER UNITS

Model **FH674**

(2) 15-3/8" W x 20" D x 2-3/4" H

E - BENCH RISER SHELVES

- Increase storage space
- Ideal for getting tools and other equipment off work surfaces
- 9" D x 12" H
- One per workbench



| Model No. | Overall Width" | Wt. lbs. |
|-----------|----------------|----------|
| FF956 | 48 | 18 |
| FF957 | 60 | 21 |
| FF958 | 72 | 24 |
| FI319 | 84 | 27 |
| FI320 | 96 | 30 |

F - LOWER SHELVES

- Add extra storage to any workbench

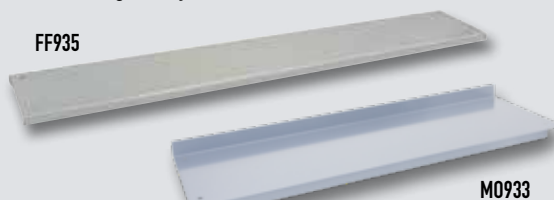

| Model No. | Overall Width" | Wt. lbs. |
|---|---------------------------|----------|
| HEAVY-DUTY (One or two 9" deep shelves can be used per workbench) | | |
| FF934 | 44 (For Use with 48" Top) | 12 |
| FF935 | 56 (For Use with 60" Top) | 15 |
| FF936 | 68 (For Use with 72" Top) | 18 |
| RL866 | 80 (For Use with 84" Top) | 21 |
| RL867 | 92 (For Use with 96" Top) | 25 |
| INDUSTRIAL DUTY (One 14 3/4" deep shelf can be used per workbench) | | |
| M0933 | 48 (For Use with 48" Top) | 15 |
| M0934 | 60 (For Use with 60" Top) | 24 |
| M0935 | 72 (For Use with 72" Top) | 30 |

G - BACK STOPS

- Add a 3" edge to the back of any workbench
- One per bench top



| Model No. | Overall Width" | Wt. lbs. |
|-----------|----------------|----------|
| FF704 | 48 | 8 |
| FF705 | 60 | 10 |
| FF708 | 72 | 12 |
| FI317 | 84 | 13 |
| FI318 | 96 | 16 |

H - END STOPS

- Add 3" sides to any workbench
- One per side desired to enclose

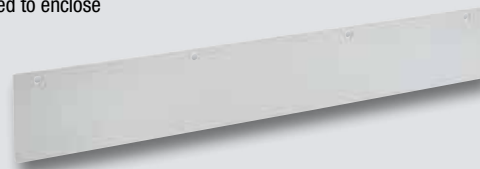

| Model No. | Overall Depth" | Wt. lbs. |
|-----------|----------------|----------|
| FF792 | 24 | 4 |
| FF793 | 30 | 5 |
| FF794 | 36 | 6 |

STAINLESS STEEL TOP WORKBENCHES

- Top constructed of 14-gauge stainless steel with a number 4 finish and formed edges
- Top reinforced with wood core for sound reduction and added strength
- 1-3/4" overall thickness
- Overall dimensions: 72" W x 30" D x 34" H
- Legs and stringers are constructed from 14-gauge steel powder coated KLETON grey finish
- Capacity: 2500 lbs. evenly distributed

Model No. **FI296**



2500 - LB. CAPACITY
Evenly Distributed





MOBILE CABINET BENCHES

- Mount one, two or three cabinets from six choices of cabinets
- Heavy-duty 11-gauge steel base, 1-1/4" thick laminated hardwood top, and a push handle
- Four 5" non-marking casters with brakes for smooth, easy rolling
- Doors are reversible, can be opened either left or right side
- All locks keyed alike by pedestal model
- Cabinet frame powder coat finish with grey shell and KLETON blue on doors and drawers
- Shipped knocked down



**1200 - LB.
CAPACITY**
Evenly Distributed

CONFIGURE YOUR OWN UNIT BY CHOOSING:

1. The pedestal style(s) that suits your needs (to a maximum of three pedestal(s))
2. Add to that the assembly kit, whether it be single, double or triple. Assembly kit includes casters, base and 1-1/4" laminated hardwood top.



1 - PEDESTAL STYLES - COMPLETE WITH LOCK AND TWO KEYS

| Model No. | Description | Wt. lbs. |
|-----------|--|----------|
| FH666 | One door | 50 |
| FH667 | Two half doors | 48 |
| FH668 | Two small drawers and one half door | 70 |
| F1166 | Two large drawers | 66 |
| F1167 | Two small drawers and one large drawer | 78 |
| FH669 | Four large drawers | 68 |
| FH670 | Four small drawers and one half door | 86 |
| FH671 | Four small drawers and two large drawers | 94 |



2 - ASSEMBLY KITS

| Model No. | Description | Wt. lbs. |
|-----------|-------------|----------|
| FH407 | Single | 27 |
| FH408 | Double | 66 |
| FH409 | Triple | 101 |



SINGLE PEDESTAL BENCHES

- Heavy gauge steel cabinet with 1" round tube frame
- Top tray lined with a rubber mat
- Full extension drawers with a capacity of 100 lbs. per drawer
- Four 4" non-marking casters with brakes for smooth, easy rolling
- Comes complete with locks and two keys
- Overall dimensions 20" W x 21" D x 37" H
- Cabinet frame powder coat finish with grey shell and KLETON blue on doors and drawers

**800 - LB.
CAPACITY**
Evenly Distributed

| Model No. | Description | Wt. lbs. |
|-----------|---------------------|----------|
| FF984 | 4-Drawer cabinet | 98 |
| MH801 | Single door cabinet | 86 |



Customize KLETON products to your specs!
See Inside Front Cover

MOBILE WORKBENCHES

INDUSTRIAL-DUTY MOBILE SERVICE BENCHES

- 16-gauge all-welded steel construction
- Designed for moving heavy parts and tools to the job site
- Provides a strong maintenance-free surface to work on
- Laminated hardwood top
- Four - 5" non-marking casters:
two rigids and two swivels with brake
- Overall dimensions: 42" W x 24" D x 37"H
- Shell durable KLETON blue enamel finish
- Cabinets are powder coat paint grey and KLETON blue
- Shipped assembled



ML325



ML326



ML327



ML328

**1200 - LB.
CAPACITY**

Evenly Distributed

| Model No. | Description | Wt. lbs. |
|-----------|------------------|----------|
| ML325 | 2 Doors | 237 |
| ML326 | 1 Drawer/1 Door | 222 |
| ML327 | 4 Drawers/1 Door | 316 |
| ML328 | 8 Drawers | 300 |

MAXI-BENCH WORKSTATIONS

- Roll your workstation to your work area
- All-welded 14-gauge frame with 30" x 60" steel wood-filled top
- Comes with 5" nylon non-marking casters, two rigid and two swivel with brakes
- Includes: 42" H peg board panel, double drawers, swivel-out stool, lower shelf, end stops
- Models FF068 (shown) and FF071 include fluorescent lamp, 25' incandescent drop light and 4-outlet power bar
- Durable KLETON blue enamel finish

**1200 - LB.
CAPACITY**

Evenly Distributed



FF068

| Model No. | Description | Overall Height" | Wt. lbs. |
|-----------|-----------------------|-----------------|----------|
| FF068 | Mobile, Complete | 76 | 340 |
| FF069 | Mobile, No Electrical | 76 | 350 |
| FF071 | Static, Complete | 70 | 380 |
| FF072 | Static, No Electrical | 70 | 363 |

CABINET WORKBENCHES

Customize KLETON
products to your specs!
See Inside Front Cover



1000 - LB. CAPACITY
Evenly Distributed

- Versatile cabinet workbench suited for any industrial application that requires work surface and secure tool and parts storage
- Durable KLETON blue enamel finish

A - CABINET SHELL ONLY

- Made of all-welded 14-gauge steel

| Model No. | Dimensions L" x W" x H" | Wt. lbs. |
|-----------|-------------------------|----------|
| FH165 | 28 x 59 x 32 | 105 |

B - TOPS

- Our complete list of tops can be found on page 76.

| Material | 30" x 60" | 30" x 72" | 36" x 60" | 36" x 72" |
|--------------------------|-----------|-----------|-----------|-----------|
| Steel Wood Filled (Grey) | FD033 | FD034 | FD035 | FD036 |
| Steel Wood Filled (Blue) | FH183 | FH184 | FH185 | FH186 |
| Laminated Wood | FI733 | FI734 | FI532 | FI738 |
| Plastic Laminated | FD011 | FD012 | FD013 | FD014 |
| Shop Top | FD004 | FD005 | FD006 | FD007 |
| Wood Bullnose Edge | FI528 | FI529 | FI532 | FI533 |
| Stainless Wood-Filled | FI271 | FI272 | FJ882 | FI277 |

C - SHELF

- Made of 14-gauge steel
- Maximum two per cabinet
- Capacity: 300 lbs.

| Model No. | Dimensions L" x W" | Wt. lbs. |
|-----------|--------------------|----------|
| FH164 | 27-3/4 x 58-3/4 | 15 |

D - DOOR

- Made of 18-gauge steel on rollers
- Recessed handles
- Includes: Plunger lock and two keys

| Model No. | Dimensions | Wt. lbs. |
|-----------|-------------------------|----------|
| FH163 | Door Set, Lock Included | 40 |

E - DRAWERS

- All-welded heavy gauge steel
- 100% full extension with ball bearing slide mechanism
- Aluminum extrusion handles with grey end caps
- All locks keyed alike by drawer model
- Includes: Locks and two keys
- Capacity: 100 lbs. per drawer evenly distributed

| Model No. | Drawer Dimensions L" x W" x H" | Wt. lbs. |
|-----------|--------------------------------|----------|
| FH938 | 15-3/8 x 20 x 5-5/8 | 30 |
| FH939 | 15-3/8 x 20 x 2-3/4 | 35 |



Customize KLETON products to your specs!
See Inside Front Cover

HEAVY-DUTY WORKBENCHES

HEAVY-DUTY MACHINE STANDS

- All-welded construction
- Designed for use as a machinery stand or work table when full workbench is not necessary
- 14-gauge steel lip-down shelves, with bolt down foot plates on 3/16" x 1-1/2" angle leg
- Overall Height: 32"
- Durable KLETON blue enamel finish

1200-LB. CAPACITY



| Model No. | Dimensions W" x D" x H" | Shelf Clearance" | Capacity lbs. | Wt. lbs. |
|-----------|-------------------------|------------------|---------------|----------|
| FH268 | 30 x 18 x 32 | 14 | 1200 | 60 |
| FH269 | 36 x 24 x 32 | 14 | 1200 | 70 |
| FH270 | 48 x 24 x 32 | 14 | 1200 | 85 |

EXTRA HEAVY-DUTY WORKBENCHES

- Our most solid workbench available with 11-gauge steel legs and stringers
- All-welded construction features a wood-filled 3/16" steel top
- Standard bolt-down foot plates
- Mobile unit has 6" phenolic casters, two swivel with brake and two rigid
- Overall height: 34"
- Durable KLETON blue enamel finish

3500 - 5000 - LB. CAPACITY
Evenly Distributed



| Model No. | Style | Dimensions W" x D" x H" | Capacity lbs. | Wt. lbs. |
|-----------|--------|-------------------------|---------------|----------|
| FF494 | Static | 72 x 30 x 34 | 5000 | 290 |
| FF495 | Static | 72 x 36 x 34 | 5000 | 295 |
| FH465 | Mobile | 72 x 30 x 34 | 3500 | 209 |
| FH466 | Mobile | 72 x 36 x 34 | 3500 | 360 |

PEDESTAL BENCHES

- Designed for workshop applications
- 1-3/4" thick solid laminated hard wood top mounted on two all-welded pedestals with two shelves each
- Pedestals are 18" W x 24" D x 32" H
- Overall height: 34"
- Durable KLETON blue enamel finish

2500-LB. CAPACITY

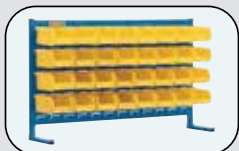

Please see page 32 for Louvered Bin Racks that can be added to Heavy-Duty Work Benches or Pedestal Benches

FF120



| Model No. | Dimensions W" x D" x H" | Wt. lbs. |
|-----------|-------------------------|----------|
| FF120 | 60 x 30 x 34 | 157 |
| FF121 | 72 x 30 x 34 | 174 |
| FF122 | 84 x 30 x 34 | 184 |
| FF119 | 120 x 30 x 34 | 275 |

INDIVIDUAL PEDESTALS

| | | |
|-------|--------------|----|
| FF127 | 18 x 24 x 32 | 42 |
|-------|--------------|----|

FOLDING TABLES

POLYETHYLENE FOLDING TABLES

- Blow molded polyethylene top
- Lightweight with folding legs for easy storage
- 29" fixed table height with locking steel legs
- Easy to clean
- Folding legs automatically lock by use of gravity activated mechanism when opened
- Top thickness: 1-5/8"
- Capacity: 500 lbs.



| Model No. | Dimensions L" x W" x H" | Wt. lbs. |
|-----------|-------------------------|----------|
| ON598 | 48 x 24 x 29 | 23 |
| ON599 | 72 x 30 x 29 | 38 |
| ON600 | 96 x 30 x 29 | 53 |

POLYETHYLENE FOLD-IN-HALF TABLES

- Blow-molded polyethylene top
- Lightweight with ability to fold the table in half to 3-1/2" thick for easy storage
- 29" fixed table height with locking steel legs
- Folding legs automatically lock by use of gravity activated mechanism when opened
- Easy to clean
- Dimensions: 72" L x 30" W x 29" H
- Top thickness: 1-5/8"
- Weight: 36 lbs
- Capacity: 350 lbs.



Model No. **ON601**



ROUND POLYETHYLENE FOLDING TABLE

- Folding legs automatically lock by use of gravity-activated mechanism when opened
- Lightweight with folding legs for easy storage
- Blow-molded high-density polyethylene top
- Top thickness: 2"
- Capacity: 395 lbs.

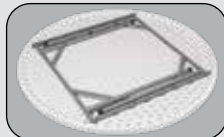

| Model No. | Dimensions L" x W" x H" | Wt. lbs. | Seats |
|-----------|-------------------------|----------|-------------|
| OQ320 | 48 x 48 x 29 | 15 | 6-8 People |
| OQ321 | 60 x 60 x 29 | 20 | 8-10 People |

SQUARE POLYETHYLENE FOLDING TABLE

- Lightweight with folding legs for easy storage
- Blow-molded polyethylene top
- Easy to clean
- Seats four people
- Dimensions: 34" W x 34" L x 29" H
- Top thickness: 1-3/4"
- Weight: 19 lbs
- 250 lbs Capacity

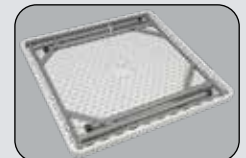

Model No. **OQ714**



FOLDING CHAIRS & BENCHES

POLYETHYLENE FOLDING CHAIRS

- Dimensions: 16-1/2" D x 18-3/4" W x 35" H
- Durable contoured back and seat for all day comfort
- Steel framing and folding legs for extra strength
- Easy to clean
- Capacity : 350 lbs.



Model

| No. | Colour |
|-------|--------|
| ON602 | White |
| OP448 | Black |
| OP449 | Blue |

STEEL FOLDING CHAIRS

- Foldable frame for easy storing
- Steel construction makes cleaning quick and easy
- Dimensions:
18" W x 17-3/4" D x 30-3/4" H
- Capacity : 300 lbs.
- 16 gauge steel
- Double riveted cross braces



Model

| No. | Seat Type | Colour |
|-------|-----------|--------|
| OP960 | Steel | Black |
| OP961 | Steel | Beige |
| OP962 | Padded | Black |
| OP963 | Padded | Beige |

DOUBLE-SIDED FOLDING CHAIR CADDY

- Holds up to 72 of the **OP448**, **OP449** and **ON602** polyethylene folding chairs OR up to 84 of the **OP963** steel folding chairs
- Easy to maneuver with 4", non-marking, blue, rubber swivel casters
- All-welded steel construction arrives ready to use
- Dimensions:
35-1/2" W x 64-1/2" L x 73" H



Model No. **OQ768**

HEAVY-DUTY ERGONOMIC STOOL, STATIONARY, ADJUSTABLE

- Polyurethane seating offers puncture and stain resistance
- Pneumatic height adjustment
- Rubber cushioned metal glides helps to protect floors
- Sturdy 5-leg base
- Dimensions:
17-1/4" D x 18-1/4" W x 39"-48" H
- Capacity : 250 lb



Model No. **OR066**

POLYETHYLENE FOLDING BENCH

- Durable high-density polyethylene construction
- Steel framing and folding legs for extra strength
- Dimensions: 72" L x 12" W x 17" H
- Folded dimensions: 36" L x 12" W x 4" H
- Weight: 21 lbs.

Model No. **ON699**



CORK BOARDS & WHITE BOARDS

HEAVY-DUTY STEEL STEP STOOL

- Comes with a double platform with non-slip rubber tread
- Spring-loaded casters retract under slight pressure, forcing base to the floor
- 11" diameter upper platform and 13-1/2" diameter lower platform
- 17-1/4" diameter base has an all-around protective bumper
- 16-1/2" overall height
- Weight: 12 lbs.
- Capacity: 330 lbs.
- Colour: Black

Model No. **ON528**

REPLACEMENT CASTER KIT

Model No. **ON617**



COMBINATION CORK/WHITE BOARDS

- Dual-purpose cork/white board provides versatility in getting your message across
- Dimensions: 24" x 36"
- Weight: 8 lbs.
- Porcelain whiteboard for a smooth and clear writing surface
- Double-sided cork for added durability
- Ideal for office or warehouse environments
- Plastic-molded corners protect the boards and wall from damage
- Sturdy aluminum frame
- Features a removable marker tray
- Can be hung vertically or horizontally

Model No. **OP542**



CORKBOARD PUSH PINS

- Plastic head, assorted colours. 100/pkg.
- Price per package

Model No. **OJ472**

CORK BOARDS

- Ideal for office or warehouse environments
- Sturdy aluminum frame
- Plastic-molded corners protect the board and wall from damage
- Double-sided cork for added durability



| Model No. | Dimensions" | Wt. lbs. |
|-----------|-------------|----------|
| ON593 | 18 x 24 | 3.5 |
| ON594 | 24 x 36 | 7 |
| ON595 | 36 x 48 | 13 |
| ON596 | 48 x 72 | 26 |
| ON597 | 48 x 96 | 35 |

WHITE BOARDS

NON-MAGNETIC

- White writing surface provides clean, colorful display
- Effortless erasing, wipes clean with cloth or felt brush
- Aluminum frame
- Plastic corners for board and wall protection

| Model No. | Dimensions H" x W" | Wt. lbs. |
|-----------|--------------------|----------|
| ON530 | 18 x 24 | 4.4 |
| ON531 | 24 x 36 | 8.0 |
| ON532 | 36 x 48 | 15.5 |
| ON533 | 48 x 72 | 29.5 |
| ON534 | 48 x 96 | 41.0 |

ON534

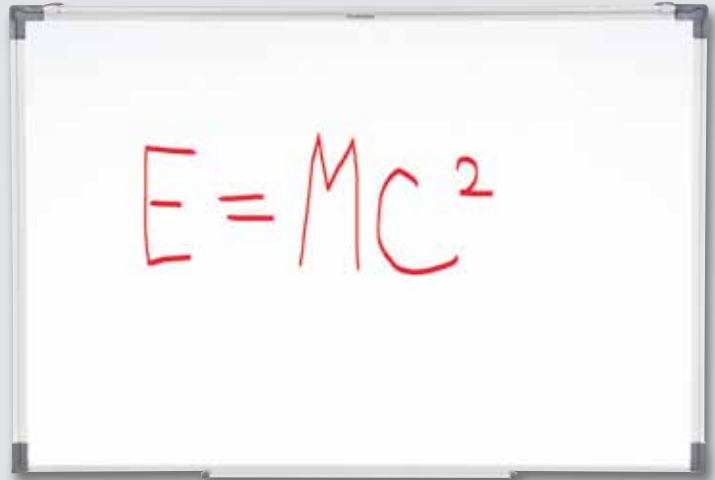

MAGNETIC

- White magnetic writing surface provides clean, colorful display
- Effortless erasing, wipes clean with cloth or felt brush
- Aluminum frame
- Plastic corners for board and wall protection
- Features a removable marker tray
- Can be hung vertically or horizontally

| Model No. | Dimensions H" x W" | Wt. lbs. |
|-----------|--------------------|----------|
| ON535 | 24 x 36 | 7 |
| ON536 | 36 x 48 | 13.5 |
| ON537 | 48 x 72 | 27 |

MAGNETIC PORCELAIN WHITE BOARDS

- White magnetic writing surface provides a clean, colourful display
- Porcelain surface is smooth and resistant to staining
- Effortless erasing, wipes clean with cloth or felt brush
- Galvanized steel backing for added durability
- Plastic corners for board and wall protection
- Mounting hardware included
- Features a removable marker tray
- Can be hanged vertically or horizontally

| Model No. | Dimensions H" x W" | Wt. lbs. |
|-----------|--------------------|----------|
| OP534 | 24 x 18 | 5 |
| OP536 | 36 x 48 | 18 |

OP536



OP534



DURA-INK® DRY ERASE INK MARKERS

- Industrial strength felt-tip ink markers for temporary marking applications
- Mark can be removed quickly and easily with dry rag, towel, or eraser
- No residue or ghosting after mark is removed on most industrial surfaces
- Suitable for any non-porous surfaces



| Model No. | Description |
|-----------|-------------|
| PE773 | Red |
| PE774 | Black |
| PE775 | Blue |
| PE776 | Green |

MARKAL

SHOP DESKS & LOCKER ROOM BENCHES

CABINET STYLE SHOP DESKS

- Durable carbon steel construction
- Same features as the open floor style shop desk, with an added double door locking cabinet
- Four-compartment organizer and slightly sloped 43" height writing surface
- Optional caster kit to convert to mobile unit
- 23" W x 16" D x 3 1/2" H locking drawer on quiet nylon rollers
- Overall dimensions: 34-1/2" W x 30" D x 53" H
- Weight: 159 lbs.
- Grey enamel finish

Model No. **FI520**



OPTIONAL CASTER KIT

Model No. **FI521**



OPEN FLOOR STYLE SHOP DESKS

- Durable carbon steel construction
- Ideal for receiving/shipping clerks, watchmen and shop foremen
- Four-compartment organizer and slightly sloped 43" height writing surface
- Optional caster kit to convert to mobile unit
- 23" W x 16" D x 3-1/2" H locking drawer on quiet nylon rollers
- Overall dimensions: 34-1/2" W x 30" D x 53" H
- Weight: 105 lbs.
- Grey enamel finish

Model No. **FI519**



OPTIONAL CASTER KIT

Model No. **FI521**



WALL-MOUNTED SHOP DESKS

- Durable carbon steel construction
- Ideal for areas with limited floor space
- Four-compartment organizer and slightly sloped writing surface
- Easy to assemble, wall brackets included
- 23" W x 16" D x 3 1/2" H locking drawer on quiet nylon rollers
- Overall dimensions: 34-1/2" W x 30" D x 31" H
- Weight: 90 lbs.
- Grey enamel finish

Model No. **FI518**



FB002



RL871

LOCKER ROOM BENCHES

- 16 gauge steel all-welded
- Wood top benches feature black powder coated legs that can be used free-standing or bolted to the floor
- Necessary for any locker room
- 9-1/4" wide rounded hardwood top

| Model No. | Type | Dimensions L" x W" x H" | Wt. lbs. |
|-----------|-------|-------------------------|----------|
| FB002 | Steel | 72 x 12 x 17 | 35 |
| RL871 | Wood | 48 x 9-1/4 x 16-1/2 | 23.5 |
| RL872 | Wood | 60 x 9-1/4 x 16-1/2 | 28 |
| RL873 | Wood | 72 x 9-1/4 x 16-1/2 | 31 |
| RL874 | Wood | 96 x 9-1/4 x 16-1/2 | 38 |



DRUM HANDLING EQUIPMENT

| | |
|------------------------------|-----|
| Drum Stacking Racks | 146 |
| Drum Grabber | 146 |
| Drum Rockers | 147 |
| Can Tipper | 147 |
| Drum Lifting Hook | 141 |
| All-in-One Drum Trucks | 147 |
| Drum Hand Trucks | 148 |
| Low Profile Drum Truck | 149 |
| Drum Dollies | 149 |

DRUM HANDLING EQUIPMENT

DRUM STACKING RACKS

- Rack holds two or three 45 imp. gal./55 US gal. drums
- Can be stacked up to three high
- Conveniently stacks drums horizontally increasing space efficiency
- Forklift access from all four sides
- Durable KLETON blue enamel finish
- Shipped knocked down

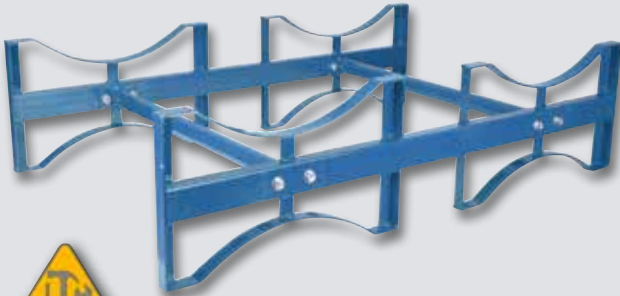

| Model No. | Drum Cap. | Overall Dimensions W" x D" x H" | Max Capacity lbs.* | Wt. lbs |
|-----------|-----------|---------------------------------|--------------------|---------|
| DC262 | 2 | 45-1/2 x 30 x 12-1/2 | 1600 | 46 |
| DC263 | 3 | 71-1/2 x 30 x 12-1/2 | 2400 | 60 |

* The total weight capacity for all drums and racks being stacked.

DRUM STACKING RACK DOLLIES

- All welded, ready to use
- Dolly allows stacking racks to be mobile
- Two rigid and two swivel casters
- Durable KLETON blue enamel finish
- Caster assembly required

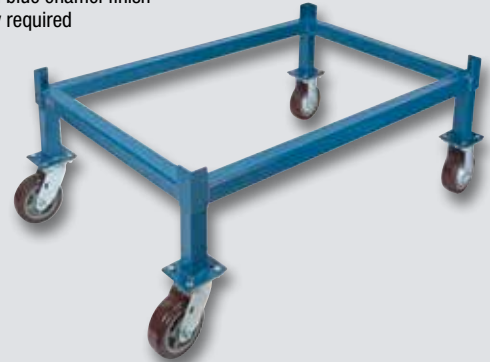

| Model No. | Wheel Type | Overall Dimensions W" x D" x H" | Capacity lbs. |
|-----------|------------------|---------------------------------|---------------|
| DC392 | 6" Hi-Temp Nylon | 46 x 30 x 9 | 1600 |
| DC393 | 6" Polyurethane | 46 x 30 x 9 | 1600 |

REPLACEMENT PARTS

- Model No. **ML861**, 6" Hi-Temp Nylon Swivel Caster
- Model No. **ML862**, 6" Hi-Temp Nylon Rigid Caster
- Model No. **ML399**, 6" Polyurethane Swivel Caster
- Model No. **ML400**, 6" Polyurethane Rigid Caster

DRUM STACKING RACK AND DOLLY KITS



DC386

SEI054, SEI052 Drip Pan and Faucet Not Included

| Model No. | Wheel Type | Overall Dimensions W" x D" x H" | Capacity lbs. |
|-----------|------------------|---------------------------------|---------------|
| DC386 | 6" Hi-Temp Nylon | 46 x 30 x 21-1/2 | 1600 |
| DC387 | 6" Polyurethane | 46 x 30 x 21-1/2 | 1600 |

Drip Pans

| Model No. | Spill Type | Dimensions L" x W" x H" |
|-----------|--------------------|-------------------------|
| SEI054 | Universal Drip Pan | 10-1/2 x 10-1/2 x 3 |
| SEI052 | Oil Only Drip Pan | 10-1/2 x 10-1/2 x 3 |

STEEL DRUM GRABBER

- Lift and transport one 45 imp./55 US gal. steel drum without the fork truck driver leaving his seat
- No risk of drum slipping since handler grips under rim of drum or rolling hoops
- Heavy gauge grabber slides onto truck forks and is locked with two turn down screws

1000-LB. CAPACITY

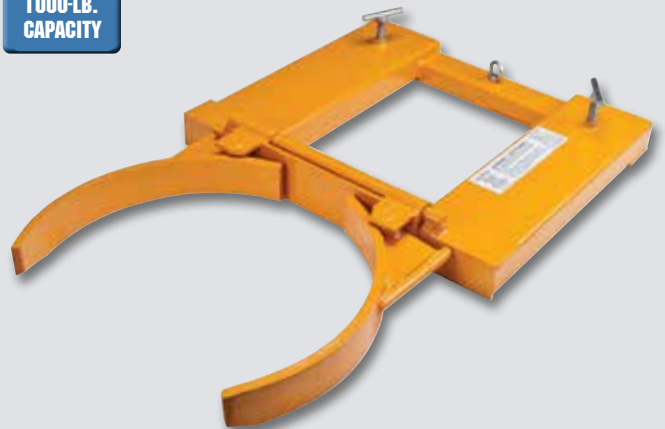

| Model No. | Description | Fork Pocket Inner Dim. W" x H" | Capacity lbs. /Drum |
|-----------|---------------------|--------------------------------|---------------------|
| DC424 | Single Drum Grabber | 5-1/2 x 2 | 1000 |

DRUM HANDLING EQUIPMENT

ALL-WELDED DRUM ROCKER

- All-welded heavy-gauge 1-1/4" steel tubing construction
- Safe method of upending up to 45 imp. gal./55 US gal. drums for moving, draining or storing
- No lifting, straining or danger of drum tipping backwards
- Load drum into the draining position in seconds
- Removable handle
- Durable KLETON blue enamel finish

**1000-LB.
CAPACITY**



CAUTION: Clamping bracket on handle must be used when maneuvering unit.

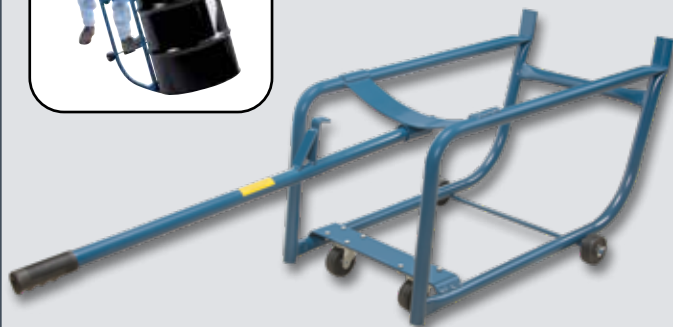

| Model No. | Description | Overall Dimensions W" x D" x H" | Wt. lbs. |
|-----------|--|------------------------------------|-------------|
| DC442 | Drum rocker with two 3" swivel casters & two 3" rigid wheels | 33 x 22 x 20 | 38 |

KNOCKED-DOWN DRUM ROCKERS

- Safe method for moving, draining and storing 45 imp. gal./55 US gal. drums
- Two 3" non-sparking wheels and two 3" non-sparking swivel casters
- Removable handle
- Powder coat finish
- Shipped knocked down

**700-LB.
CAPACITY**

CAUTION: Clamping bracket on handle must be used when maneuvering unit.

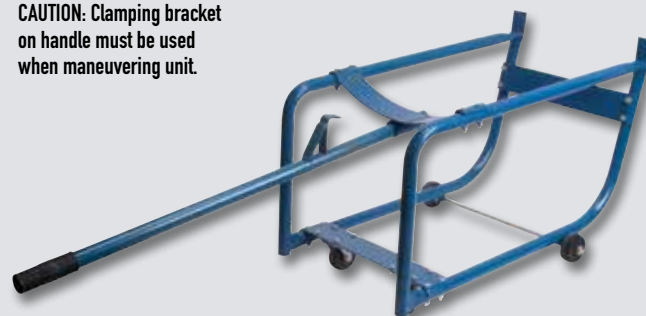

| Model No. | Description | Overall Dimensions W" x D" x H" | Wt. lbs. |
|-----------|---|------------------------------------|-------------|
| DC443 | Rocker with two 3" non-sparking wheels and two 3" non-sparking swivel casters | 33 x 22 x 20 | 34 |

REPLACEMENT PARTS

Model No. **DC464**, 3" Polyolefin Wheel

Model No. **DC463**, 3" Polyolefin Swivel Caster

Model No. **DC473**, Handle & Black Plastic Handle Grip

CAN TIPPER

- Handles 4 imp. gal./5 US gal. round pails
- Safety lever holds container in place
- Dispensing height of 11-1/2"
- Capacity: 75 lbs.
- Weight: 12 lbs.
- Shipped knocked down

Model No. **DC472**



DC472



DRUM LIFTING HOOK

- Horizontally lifts 45 imp. gal./55 US gal. steel drums, 34" - 36" long
- Alloy steel lifting ring, steel rods, malleable iron hooks
- Capacity: 1000 lbs.
- Weight: 5 lbs.

Model No. **DC449**



DC449

DRUM HANDLING EQUIPMENT

ALL-IN-ONE DRUM TRUCKS

- All-welded, 1-1/4" round tubular steel frame
- Can be used to transport and dispense drums
- Easy-to-use belt-system and hook keeps drums securely on the truck
- Easy to load and unload on skids
- Handles plastic steel or fibre drums
- Loop handle models provides added leverage while dual handle models provide side body comfort
- Four wheel design for added support and easy manoeuvrability
- Durable KLETON blue enamel finish



Retaining Hook



**1200-LB.
CAPACITY**

| Model No. | Handle Type | Wheel Type | Wt. lbs. |
|-----------|-------------|--------------------|----------|
| DC266 | Loop | 10" Mold-On Rubber | 68 |
| DC267 | Loop | 10" Pneumatic | 50 |
| DC256 | Dual | 10" Mold-On Rubber | 54 |
| DC257 | Dual | 10" Pneumatic | 59 |

REPLACEMENT PARTS

Model No. **ML069**, 10" Pneumatic Wheel
 Model No. **MN694**, 10" Mold-on Rubber Wheel
 Model No. **PF805**, 2" Pull Strap

HAND TRUCK FOR PLASTIC AND FIBRE DRUMS

- All-welded, 1-1/4" round tubular steel frame
- Handles plastic and fibre drums from 18" to 25" in diameter and 24" to 41" in height
- 2" ratchet strap secures drum in place
- Rolls on 10" front and 6" rear rubber-tired wheels
- Durable KLETON blue enamel finish



**1000-LB.
CAPACITY**

| Model No. | Description | Overall Dimensions W" x D" x H" | Wt. lbs. |
|-----------|-----------------------------------|------------------------------------|----------|
| DA595 | Truck for plastic and fibre drums | 24 x 22 x 58 | 55 |

REPLACEMENT PARTS

Model No. **MH296**, 6" Mold-on Rubber Wheel
 Model No. **MN694**, 10" Mold-on Rubber Wheel
 Model No. **MA382**, Black Plastic Handle Grip
 Model No. **PF805**, 2" Pull Strap



**1000-LB.
CAPACITY**

DA594

DRUM HAND TRUCKS

- All-welded 1-1/4" round tubular steel frame
- Handles containers from as small as 18" in diameter to large 55-gallon steel drums
- Ideal for loading drums onto pallets, or for going over curbs or uneven docks
- Free standing when loaded
- Durable KLETON blue enamel finish

| Model No. | Description | Overall Dimensions W" x D" x H" | Wt. lbs. |
|-----------|--|------------------------------------|----------|
| DA593 | Truck with 10" front rubber wheels only | 24 x 19 x 58 | 48 |
| DA594 | Truck with 10" front and 6" rear rubber wheels | 24 x 22 x 58 | 50 |

REPLACEMENT PARTS

Model No. **MH296**, 6" Mold-on Rubber Wheel
 Model No. **MN694**, 10" Mold-on Rubber Wheel
 Model No. **MA382**, Black Plastic Handle Grip

DRUM HANDLING EQUIPMENT

LOW PROFILE DRUM TRUCK

- All-welded steel construction with 8" x 2" rubber wheels and 4" non-marking rubber swivel casters for smooth movement and easy manoeuvrability
- Ideal for moving full, open top 45 imp. gal./55 US gal. drums without spilling contents
- With a low-level frame, only 1" from the ground, this truck allows for easy loading of drums
- Hinged handle moves forward and backward for easy pushing or pulling
- Quality powder coat finish
- Shipped knocked down



1000-LB. CAPACITY

DC500



| Model No. | Overall Dimensions W" x D" x H" | Overall Handle Length" | Wt. lbs. |
|-----------|------------------------------------|------------------------|----------|
| DC500 | 30 x 24 x 46 | 39 | 49 |

REPLACEMENT PARTS

- Model No. **ML333**, 4" Non-Marking Rubber Swivel Caster
 Model No. **ML813**, 8" Mold-on Rubber Wheel
 Model No. **DC502**, Black Plastic Handle Grip

STEEL ROUND FRAME DRUM DOLLIES

- Welded 3/16" thick x 4", frames are built to withstand constant use
- 24" inside diameter handles 45 imp. gal./55 US gal. drums
- Comes with four swivel casters
- Quality powder coat finish
- Shipped knocked down

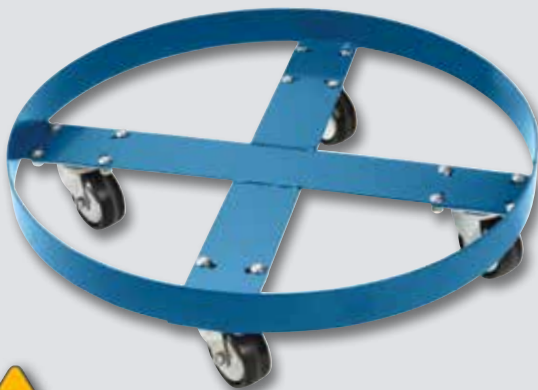

| Model No. | Caster Type | Caster Size" | Caster Height" | Capacity lbs. | Wt. lbs. |
|-----------|--------------|---|----------------|---------------|----------|
| DC202 | Polyolefin | 3 | 4-1/2 | 750 | 23 |
| DC199 | Polyurethane | 3 | 4-1/2 | 1000 | 24 |
| DC200 | Polyurethane | 4 | 5-1/2 | 1500 | 27 |
| DC070 | Frame Only | (Fits caster hole spacings of 1-5/8" x 3" to 2-3/4" x 3-1/4") | | 16 | |

REPLACEMENT PARTS

- Model No. **ML391**, 3" Polyolefin Swivel Caster
 Model No. **ML044**, 3" Polyurethane Swivel Caster
 Model No. **ML045**, 4" Polyurethane Swivel Caster

STEEL X-FRAME DRUM DOLLIES

- Welded 3/16" thick x 4", frames are built to withstand constant use
- 24" inside diameter handles 45 imp. gal./55 US gal. drums
- Comes with four swivel casters
- Quality powder coat finish
- Shipped knocked down

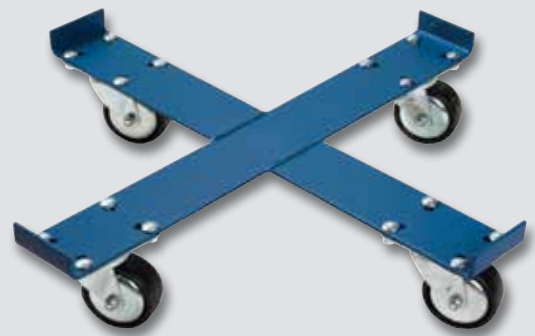

| Model No. | Caster Type | Caster Size" | Caster Height" | Capacity lbs. | Wt. lbs. |
|-----------|--------------|---|----------------|---------------|----------|
| DC206 | Polyolefin | 3 | 4-1/2 | 750 | 15 |
| DC203 | Polyurethane | 3 | 4-1/2 | 1000 | 16 |
| DC204 | Polyurethane | 4 | 5-1/2 | 1500 | 19 |
| DC071 | Frame Only | (Fits caster hole spacings of 1-5/8" x 3" to 2-3/4" x 3-1/4") | | 8 | |

REPLACEMENT PARTS

- Model No. **ML391**, 3" Polyolefin Swivel Caster
 Model No. **ML044**, 3" Polyurethane Swivel Caster
 Model No. **ML045**, 4" Polyurethane Swivel Caster



DRUM PUMPS & ACCESSORIES

| | |
|-------------------------|-----------|
| Drum Accessories | 151 |
| Drum Faucets | 151 |
| Drum Valves | 151 |
| Drum Vents | 151 |
| Bung Nut Wrenches | 151 |
| Drum Pumps | 152 - 156 |
| Water Pumps | 157 - 158 |

WARNING! Chemical compatibility of a drum or barrel pump should be checked for EACH LIQUID BY CHEMICAL NAME! Please contact your KLETON representative for chemical compatibility. No single drum pump can be universally chemical resistant. Some blends of chemicals may not be suitable for any of these drum pumps. Remember to have your MSDS for each chemical that will be dispensed when calling your KLETON representative. We will be able to help you select the right pump for your application.

DRUM ACCESSORIES

SELF-CLOSING GATE VALVE

- For use with viscous non-corrosive fluids heavier than SAE30 motor oil
- Heavy-duty brass construction
- Self-closing PTFE blade has fast, positive shut off when handle is released
- 4-1/2" wide handle
- Wide opening permits maximum flow
- Fits 2" bung in steel or plastic drums
- Weight: 7 lbs.

Model No. **PE363**

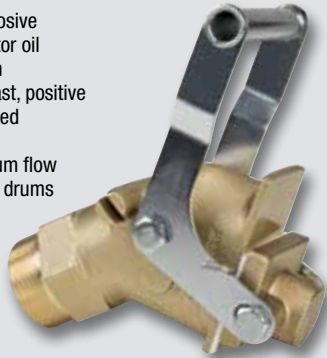

SELF-CLOSING FAUCET WITH SCREEN

- Flame arrester safety faucet
- Standard 3/4" tapered pipe thread
- Can be padlocked closed
- Natural zinc die cast finish
- Weight: 1 lbs.

Model No. **PE364**

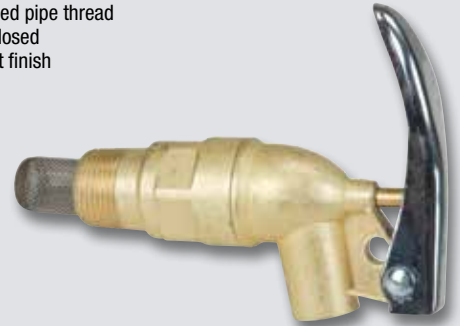

SELF-CLOSING FAUCET

- For non-flammable liquids only
- No flame arrester
- 3/4" pipe thread
- Can be padlocked closed
- Natural zinc die cast finish
- Weight: 0.5 lbs.

Model No. **PE365**



HORIZONTAL BRASS VENT

- Horizontal vents are for use with drums in the horizontal pouring position
- Automatically relieves pressure at 5 PSI
- Flame arrester prevents sparks and flame from igniting contents
- Manual vacuum relief by lifting and rotating the valve stem
- Maximum flow of 220 CFM at 20 PSI
- Fits 2" NPS bung in steel or plastic drums
- Weight: 1 lbs.

Model No. **PE362**



BUNG NUT WRENCHES

- Fits almost any metal or plastic, male or female bung nuts or plugs
- Offset handle
- 13" overall length
- Weight: 4 lbs.

Model No. **DA638**

Constructed of: Annealed ductile iron

Model No. **DA637**

Constructed of: Non-sparking, manganese bronze alloy

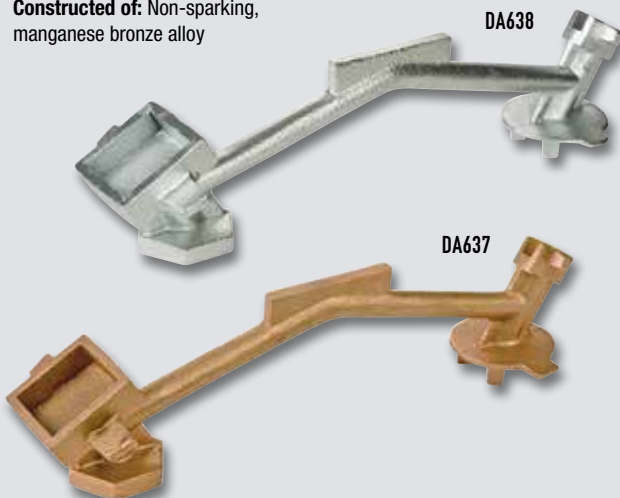

DELUXE PLUG WRENCH

- Non-sparking brass alloy wrench fits virtually all industrial drums including those with square or hex plugs, male or female bung nuts or plugs and fittings with lugs and crossbars
- Built-in 1-1/4" wrench for tightening faucets into drums; eliminates the need for extra tools
- Weight: 2 lbs.

Model No. **PE359**



DRUM PUMPS

WARNING! Chemical compatibility of a drum or barrel pump should be checked for EACH LIQUID BY CHEMICAL NAME! Please contact your KLETON representative for chemical compatibility. No single drum pump can be universally chemical resistant. Some blends of chemicals may not be suitable for any of these drum pumps. Remember to have your MSDS for each chemical that will be dispensed when calling your KLETON representative. We will be able to help you select the right pump for your application.

STAINLESS STEEL PULL TYPE DRUM PUMP

Wetted components:

304 stainless steel, brass, polyethylene and steel.

- Use with certain acids and alkalis
- Fits 5 to 55-gallon drums with a 2" bung adaptor
- Transfer rate: 8 oz. per stroke

Model No. **DA530**



Wetted components:

304 stainless steel, 316 stainless steel, brass and PTFE.

- For most acids and corrosives
- Fits 5 to 55-gallon drums with a 2" bung adaptor
- Transfer rate: 8 oz. per stroke

Model No. **DA531**



Wetted components:

304 stainless steel, polyethylene and PTFE.

- For fast transfer of most acids and corrosives
- Fits 55-gallon drums with a 2" bung adaptor
- Transfer rate: 22 oz. per stroke

Model No. **DA529**



Wetted components:

304 stainless steel, 316 stainless steel and PTFE.

- For fast transfer of most acids and corrosives
- Fits 55-gallon drum with a 2" bung adaptor
- Transfer rate: 22 oz. per stroke
- For most organic acids, alcohols and solvents

Model No. **DB845**



STEEL PULL TYPE DRUM PUMP

Wetted components:

Brass, steel and polyethylene.

- For most non-corrosive and non-flammable liquids
- Fits 5 to 55-gallon drums with a 2" bung adaptor
- Transfer rate: 8 oz. per stroke

Model No. **DA527**



Wetted components:

Buna-N, polyethylene, leather and steel.

- For most water-soluble inorganic acids, waxes, detergents
- Fits 5-gallon pails with a 2" bung adaptor
- Transfer rate: 8 oz. per stroke

Model No. **DC113**



Wetted components:

Polyethylene, steel and zinc.

- Use with most non-corrosive, light to medium viscosity liquids
- Fits 55-gallon drum with a 2" bung adaptor
- 3/4" diameter spout can be rotated to 180° and removed to expose garden hose thread
- Transfer rate: 22 oz. per stroke

Model No. **DC114**



ALUMINUM DIAPHRAGM HAND PUMPS

Wetted components:

Aluminum, Buna-N, Poly Acetal, 304 stainless steel and steel.

- For use with most motor oil and other light petroleum products
- Fits 15 to 55-gallon drums with 2" bung adaptor
- Transfer Rate: 25.5 oz. per stroke
- Includes a safety locking latch and discharge hose

Model No. **DC068**



WARNING! Chemical compatibility of a drum or barrel pump should be checked for EACH LIQUID BY CHEMICAL NAME! Please contact your KLETON representative for chemical compatibility. No single drum pump can be universally chemical resistant. Some blends of chemicals may not be suitable for any of these drum pumps. Remember to have your MSDS for each chemical that will be dispensed when calling your KLETON representative. We will be able to help you select the right pump for your application.

DRUM PUMPS

PULL TYPE DRUM PUMPS

POLYPROPYLENE

Wetted components:

Polyethylene, polypropylene, silicone and steel.

- For use with most corrosive chemicals and non-flammable solvents
- Fits 5 to 55-gallon drums with 3/4" or 2" bung adaptor
- 360° discharge spout orientation
- Transfer rate: 16 oz. per stroke

Model No. **DC115**

**Wetted components:**

Polypropylene, steel and Viton®.

- For use with most antifreeze, detergents, windshield fluids, glycerin, and mild acids
- Fits 15 to 55-gallon drums with 2" bung adaptor
- Transfer rate: 14 oz. per stroke

Model No. **DC127**

**Wetted components:**

Polyethylene, polypropylene and nylon.

- For use with most corrosive chemicals, water, and non-flammable solvents
- Good insulation from spark and fire
- Fits 55-gallon drums with a 2" bung adaptor
- Transfer rate: 22 oz. per stroke

Model No. **DC117**

**Wetted components:**

Polypropylene, polyethylene, silicone and steel.

- For use with most corrosive chemicals and non-flammable solvents
- Adapts to 3/4" or 2" bung adaptor for 5 to 55-gallon drums
- 360° discharge spout orientation
- Transfer rate: 8 oz. per stroke

Model No. **DA532**



PVC

Wetted components:

Polypropylene, nylon, PVC and Viton®.

- For use with most mild acids, detergents, water and solvents
- Good insulation from spark and fire
- Adapts to 3/4" or 2" bung adaptor for 5 to 55-gallon drums
- Transfer rate: 8 oz. per stroke

Model No. **DC116**

**Wetted components:**

PVC, nylon and Viton®.

- For use with most mild acids, detergents, water and solvents
- Good insulation from spark and fire
- Fits 55-gallon drums with a 2" bung adaptor
- Transfer rate: 22 oz. per stroke

Model No. **DC118**



NYLON

Wetted components:

Polypropylene, nylon, 304 stainless steel and PTFE.

- For use with most lacquer thinners, mild acids, detergents, water and light viscosity petroleum liquids
- Fits 15 to 55-gallon drums with 2" bung adaptor
- Transfer rate: 14 oz. per stroke

Model No. **DC128**



DRUM PUMPS

WARNING! Chemical compatibility of a drum or barrel pump should be checked for EACH LIQUID BY CHEMICAL NAME! Please contact your KLETON representative for chemical compatibility. No single drum pump can be universally chemical resistant. Some blends of chemicals may not be suitable for any of these drum pumps. Remember to have your MSDS for each chemical that will be dispensed when calling your KLETON representative. We will be able to help you select the right pump for your application.

ROTARY LOBE PUMP OVERVIEW

Lobe pumps are popular in diverse industries because they offer superb sanitary qualities, high efficiency, reliability, corrosion resistance and good clean-in-place and sterilize-in-place characteristics.

Rotary lobe pumps are non-contacting and have large pumping chambers. If wetted, they offer self-priming performance. A gentle pumping action minimizes product degradation. They also offer reversible flows and can operate dry for long periods of time.

Advantages:

- Pass medium solids
- No metal-to-metal contact
- Superior CIP/SIP capabilities
- Long term dry run (with lubrication to seals)
- Non-pulsating discharge

Wetted components:

Aluminum, Buna-N, cast iron, chrome plated, polypropylene, steel and zinc.

- For use with most low viscosity and non-corrosive petroleum based fluids
- Dual directional operation for rapid discharge
- Fits 55-gallon drums with a 2" bung adaptor
- Transfer rate: 1 liter per revolution

Model No. **DC111**



LEVER TYPE DRUM PUMPS

Wetted components:

- 304 stainless steel, chrome plated, polyethylene, polypropylene and Viton®.
- Use with certain water-based solvents, mild acids and light viscosity petroleum liquids
 - Adapts to 1-1/2" or 2" bung adaptor for 5 to 55-gallon drums
 - Transfer rate: 14 oz. per stroke

Model No. **DC121**



Wetted components: 316 stainless steel, polypropylene, polyphenylene sulfide and PTFE.

- Use with most water-based solvents, strong acids or alkalis and light viscosity petroleum liquids
- Adapts to 1-1/2" or 2" bung adaptor for 5 to 55-gallon drums
- Transfer rate: 14 oz. per stroke

Model No. **DC122**



Wetted components:

- 316 stainless steel and PTFE.
- Use with certain water-based solvents, strongest acids or alkaline solutions
 - Adapts to 1-1/2" or 2" bung adaptor for 5 to 55-gallon drums
 - Transfer rate: 14 oz. per stroke

Model No. **DC123**



Wetted components: Brass, Buna-N, polyethylene, steel and zinc.

- Use with most dispensing and transferring non-corrosive and petroleum based fluids
- Cushioned vinyl grip handle
- Discharge spout can be rotated 180° and removed to expose garden hose threaded outlet
- Adapts to 1-1/2" or 2" bung adaptor for 30 to 55-gallon drums
- Transfer rate: 11 oz. per stroke

Model No. **DC124**



POLYETHYLENE SIPHON PUMPS

Wetted components:

Polyethylene

- Use for most water based liquids, light oils and detergents
- Air vent in handle controls flow
- Fits 5-gallon pails
- Transfer rate: 2 gallons/minute

Model No. **DC120**



Wetted components:

Polyethylene

- Use with water based liquids, light oils and detergents
- Air vent in handle controls flow
- Fits 15 to 55-gallon drums with 2" bung adaptor
- Transfer rate: 7 gallons/minute

Model No. **DC119**



PAIL TYPE PUMP

Wetted components:

Delrin®, polyethylene, PVC and steel.

- For use with most engine oils, gear oils and antifreeze
- Fits 5 gallon pails
- Includes a 48" discharge hose fitted with curved metal spout at discharge end
- Transfer rate: 2 oz. per stroke
- Comes with a Rieke® adaptor

Model No. **DC129**



WARNING! Chemical compatibility of a drum or barrel pump should be checked for EACH LIQUID BY CHEMICAL NAME! Please contact your KLETON representative for chemical compatibility. No single drum pump can be universally chemical resistant. Some blends of chemicals may not be suitable for any of these drum pumps. Remember to have your MSDS for each chemical that will be dispensed when calling your KLETON representative. We will be able to help you select the right pump for your application.

DRUM PUMPS

ROTARY TYPE DRUM PUMPS

ROTARY VANE PUMP OVERVIEW

While vane pumps can handle moderate viscosity liquids, they excel at handling low viscosity liquids such as LP gas (propane), ammonia, solvents, alcohol, fuel oils, gasoline and refrigerants. Vane pumps have no internal metal-to-metal contact and self-compensate for wear, enabling them to maintain peak performance on these non-lubricating liquids. Vane pumps are noted for their dry priming, ease of maintenance, and good suction characteristics over the life of the pump.

ADVANTAGES

- Handles thin liquids at relatively higher pressures
- Compensates for wear through vane extension
- Sometimes preferred for solvents, LP gas
- Can run dry for short periods
- Can be equipped with a gasket or a stuffing box
- Develops good vacuum

ALUMINUM

Wetted components:

Aluminum, Buna-N, PVC nitrile, steel and zinc.

- For use with most low viscosity, non-corrosive petroleum based fluids and lubricating oils up to SAE30
- Fits 15 to 55-gallon drums with a 2" bung adaptor
- Transfer rate: 6-3/4 oz. per revolution
- Includes a safety locking latch
- 3/4" dia. x 1.8 m long PVC nitrile discharge hose included

Model No. **DC126**



POLYPROPYLENE

Wetted components:

304 stainless steel, polypropylene, PTFE and Viton®, PVDF

- For water-soluble inorganic acids, waxes, detergents
- Fits 15 to 55-gallon drums with a 2" bung adaptor
- Transfer rate: 8 oz. per revolution

Model No. **DB998**



POLYPHENYLENE SULFIDE AND STAINLESS STEEL

Wetted components:

304 stainless steel, PVDF, polyphenylene sulfide and PTFE.

- Use with most aggressive chemicals such as hydrocarbons and ketones
- Fits 15 to 55-gallon drums with a 2" bung adaptor
- Transfer rate: 12 oz. per revolution

Model No. **DC335**



STEEL AND CAST IRON

Wetted components:

Buna-N, cast iron, polyethylene, polypropylene and steel.

- For use with most medium viscosity petroleum fluid, light non-flammable and non-combustible fluids
- Dual directional operation allows pump to both empty and refill containers
- Fits 30 to 55-gallon drums with a 2" bung adaptor
- Transfer rate: 8 oz. per revolution
- Steel discharge spout and polyethylene discharge hose of 1" diameter and 55" long included

Model No. **DA528**

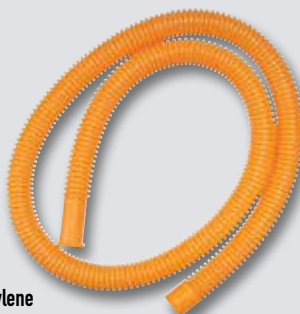

DC098
Polyethylene
discharge hose



DRUM PUMPS

WARNING! Chemical compatibility of a drum or barrel pump should be checked for EACH LIQUID BY CHEMICAL NAME! Please contact your KLETON representative for chemical compatibility. No single drum pump can be universally chemical resistant. Some blends of chemicals may not be suitable for any of these drum pumps. Remember to have your MSDS for each chemical that will be dispensed when calling your KLETON representative. We will be able to help you select the right pump for your application.

PTFE

Wetted components:
304 Stainless Steel, PVDF and PTFE.

- For most aggressive chemicals such as acids and alkalines
- Fits 30 to 55-gallon drums with a 2" bung adaptor
- Transfer rate: 12 oz. per revolution

Model No. **DB997**



STAINLESS STEEL

Wetted components:
304 stainless steel, PVDF and PTFE.

- For most organic acids, alcohols and solvents
- Fits 15 to 55-gallon drums with a 2" bung adaptor
- Transfer rate: 12 oz. per revolution

Model No. **DB759**



FM APPROVED ALUMINUM & CAST IRON ROTARY PUMP

Wetted components:
Cast iron, steel, graphite, polypropylene, aluminum, EPDM rubber and Buna-N

- FM approved pump with 8' antistatic hose, nozzle, flame arrestor and vacuum breaker
- For use with class 1 and class 2 flammable and combustible liquids such as gasoline, alcohols, and other solvents
- Fits 15 to 55-gallon drums with a 2" bung adaptor
- Transfer rate: 10 gallons per minute

Model No. **DC505**

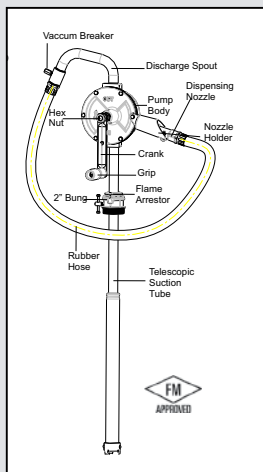

PUMP SPECIFICATIONS

| | |
|---------------------------|-------------------------------|
| Inlet / Outlet | 3/4" NPT (F) |
| Flow | 38 LPM (10 GPM) @120 RPM |
| Maximum Fluid temperature | 250°F/ 120°C |
| Mounting | 2" MNPT Bung Adapter |
| Suction Tube Length | 18.2" (460mm) to 34.5"(875mm) |

FM APPROVED PULL TYPE DRUM PUMP

Wetted components:
316 Stainless Steel, PTFE

- For fast transfer of most solvents, acids and corrosives chemicals
- Fits 15-55-gallon drums with a 2" bung adaptor
- Pump body made from 316 Stainless Steel with PTFE Piston & PTFE Sealing Gasket
- Heavy-Duty bonding and grounding wires prevent hazardous static charge
- Wires are secured by locknut and have heavy-duty alligator clips
- Built-in internal flame arrestor prevents flame flashback
- Fits Gallon Size: 55 Gal.
- Body Material: Stainless Steel

Model No. **DC765**



PUMP SPECIFICATIONS

| | |
|---------------------------|----------------------|
| Inlet / Outlet | N/A |
| Flow | 7 oz./Stroke |
| Maximum Fluid temperature | 140°F/ 60°C |
| Mounting | 2" MNPT Bung Adapter |
| Suction Tube Length | 22" (550mm) |

SUBMERSIBLE UTILITY PUMP

- Voltage: 115 V
- Continuous duty and easy access handle for portability
- Corrosion-resistant, reinforced thermoplastic construction
- Bottom suction design filters debris and removes water down to 1/4" from surface
- Built-in automatic thermal overload protector motor
- 3/4" NPT discharge, 1-1/4" adapter included
- Top discharge design
- 10' power cord



| Model No. | Motor HP | Max. Flow Rate | Amps |
|-----------|----------|----------------|------|
| DC651 | 1/3 | 2160 GPH | 4 |

AUTOMATIC SUBMERSIBLE UTILITY PUMP

- Motor: 1/3 HP
- Max. Flow Rate: 2160 GPH
- Voltage: 115 V
- Amps: 4 A
- Automatically turns on when 1-1/2" of water is detected; turns off when water level falls below 1/4"
- Corrosion-resistant, reinforced thermo plastic construction
- Bottom suction design filters debris and removes water down to 1/4" from surface
- Permanent split capacitor motor and built-in automatic thermal overload protector
- 1" NPT discharge, 3/4" adapter included
- 10' power cord

Model No. **DC652**



AUTOMATIC POOL COVER PUMP

- Motor: 1/4 HP
- Max. Flow Rate: 2310 GPH
- Voltage: 115 V
- Suction Head: 20'
- Automatically turns on when 2" of water is detected
- Corrosion-resistant, reinforced thermoplastic construction
- Bottom suction design filters debris and removes water down to 1/4"
- Built-in automatic thermal overload protector
- 25' power cord
- 3/4" NPT check valve adapter included

Model No. **DC654**



PORTABLE TRANSFER PUMP

- Motor: 1/10 HP
- Max. Flow Rate: 264 GPH
- Voltage: 115 V
- Suction Head: 46'
- Built-in automatic thermal overload protection
- Convenient carrying handle for easy transport
- 3/4" NPT discharge
- Garden hose included
- 6' power cord
- Water suction attachment included

Model No. **DC655**



WATER PUMPS

STAINLESS STEEL HOUSING-CAST IRON BASE SUMP PUMP

- Voltage: 115 V
- Stainless steel motor shell with durable cast iron volute
- Oil-filled permanent split capacitor motor
- Built-in automatic thermal overload protector
- Works with vertical or piggy back float switch for automatic operation
- 1-1/2" discharge
- Sturdy base prevents clogs and prevents pump from moving around in the pit
- 8' power cord



| Model No. | Motor HP | Max. | |
|-----------|----------|-----------|------|
| | | Flow Rate | Amps |
| DC659 | 1/3 | 3630 GPH | 4.5 |
| DC660 | 1/2 | 4400 GPH | 5 |

CAST IRON SEWAGE PUMP

- Motor: 1/2 HP
- Max. Flow Rate: 3880 GPH
- Voltage: 115 V
- Amps: 6.5 A
- Max. Diameter of Waste: 2"
- Durable cast iron construction
- Heavy duty cast iron volute and impeller
- Built-in automatic thermal overload protector motor
- Adjustable tethered or piggy back float switch for automatic operation
- 2" NPT discharge
- 10' power cord



Model No. **DC661**

DUAL VOLTAGE CAST IRON SHALLOW WELL JET PUMP

- Motor: 1/2 HP
- Max. Flow Rate: 710 GPH
- Voltage: 115/ 230 V
- Suction Head: 25'
- For use with shallow well within 25ft
- Durable cast iron pump body
- Built-in automatic thermal overload protection
- Pressure switch pre-set at 30-50 PSI
- 1-1/4" NPT suction and 1" NPT discharge

Model No. **DC662**



DUAL VOLTAGE CAST IRON CONVERTIBLE JET PUMP

- Motor: 1 HP
- Max. Flow Rate: 920 GPH
- Voltage: 115/ 230 V
- Suction Head: 198'
- For use on shallow well applications up to 25ft water level
- For use on deep well applications up to 25-80 feet
- Durable cast iron pump body
- Built-in automatic thermal overload protection
- Ejector is included for deep well usage
- 1-1/4" NPT suction and 1" NPT discharge

Model No. **DC664**





PACKAGING TOOLS

| | | | |
|------------------------------|-----------|------------------------------------|-----------|
| Utility Knives | 160 - 161 | Steel Strapping & Tools | 169 - 171 |
| Packing List Envelopes | 162 | Steel Strapping Dispensers | 169 |
| Poly Bags | 162 | Plastic Strapping | 172 |
| Tape Guns & Tape | 164 - 165 | Plastic Strapping Tools | 172 - 173 |
| Sealers | 167 | Plastic Strapping Dispensers | 172 |
| Stretch Wrap Dispenser | 167 | Glue Guns | 174 |
| Carton Sizer | 167 | Cable Ties | 174 |
| Bag Sealer | 167 | Staple Guns | 175 |
| Steel Strapping | 169 | Hammer Tackers | 175 |

UTILITY KNIVES

HEAVY-DUTY UTILITY KNIFE ATK100

- Auto-reload blade change
- Auto-lock blade
- Thumb operated screw-lock for heavy-duty operation
- Rubber handle insert for superior grip
- Snap-off blades
- Attached blade snapper
- Includes 4 heavy-duty blades
- Use 18 mm blade

Model No. **PE812**



PROFESSIONAL UTILITY KNIFE ATK300

- Auto-lock blade
- Snap-off blades
- Attached blade snapper
- Use 18 mm blade

Model No. **PE814**



PROFESSIONAL UTILITY KNIFE ATK400

- Blade screw lock
- Snap-off blades
- Comes with blade snapper
- Use 18 mm blade

Model No. **PE813**



STANDARD-DUTY UTILITY KNIFE ATK600

- Snap-off blades
- Attached blade snapper
- Includes one extra blade
- Use 9 mm blade

Model No. **PE345**



STANDARD-DUTY UTILITY KNIFE ATK700

- Auto-lock blade
- Durable ABS plastic body
- Snap-off blades
- Attached blade snapper
- Lightweight design
- Use 18 mm blade

Model No. **PE549**

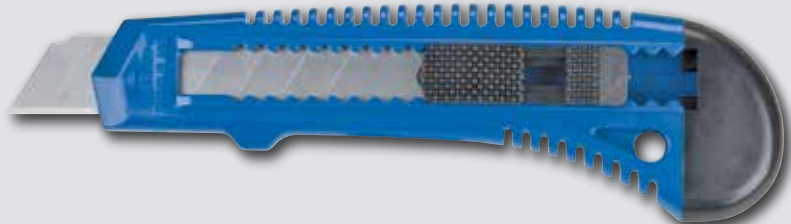



STAINLESS STEEL UTILITY KNIFE ATK500

- Auto-lock blade
- Snap-off blades
- Attached blade snapper
- Built-in belt clip
- Uses 9 mm blade

Model No. **PE815**



HEAVY-DUTY UTILITY KNIFE ATK800

- Blade Dimensions: 25 mm x 139 mm
- Blade Thickness: 0.7 mm
- Locking Mechanism: Screw
- Ergonomic handle for superior grip
- Snap-off blades
- Uses 25 mm blade

Model No. **PF710**



HEAVY-DUTY UTILITY KNIFE ATK900

- Blade Dimensions: 18 mm x 139 mm
- Blade Thickness: 0.7 mm
- Locking Mechanism: Screw
- Ergonomic handle for superior grip
- Snap-off blades
- Uses 25 mm blade

Model No. **PF711**



SELF-RETRACTING UTILITY KNIFE ATK1000

- Self-retracting blade for heightened safety
- Durable ABS plastic body
- Lightweight design

Model No. **PF708**

Model No. **PF709** - Replacement Blades



UTILITY KNIFE BLADES

| Model No. | Blade Size | Thickness | Qty /Pack |
|--------------|------------|-----------|-----------|
| PE407 | 9 mm | 0.4 mm | 10 |
| PF205 | 18 mm | 0.5 mm | 10 |
| PE410 | 25 mm | 0.7 mm | 10 |

PACKAGING ACCESSORIES

2 MIL - RECLOSABLE POLY BAGS

- Hang-holes allow users to hang on hooks or pegs
- Zippered opening allows for easy opening and resealing
- 2-mil thickness
- 100/pack



| Model No. | Dimensions W" x L" |
|-----------|--------------------|
| PF915 | 3 x 4 |
| PF919 | 3 x 5 |
| PF922 | 4 x 4 |
| PF925 | 4 x 6 |
| PF928 | 4 x 8 |
| PF929 | 5 x 7 |
| PF932 | 5 x 8 |
| PF935 | 6 x 6 |
| PF937 | 6 x 8 |
| PF942 | 6 x 9 |
| PF946 | 8 x 10 |
| PF949 | 9 x 6 |
| PF950 | 9 x 12 |
| PF954 | 10 x 12 |
| PF957 | 10 x 13 |
| PF958 | 12 x 12 |
| PF961 | 12 x 15 |
| PF965 | 15 x 20 |

2 MIL WHITE BLOCK RECLOSABLE POLY BAGS

- Hang-holes allow users to hang on hooks or pegs
- Identify contents by writing on the white block area
- Zippered opening allows for easy opening and resealing
- 2-mil thickness
- 100/pack

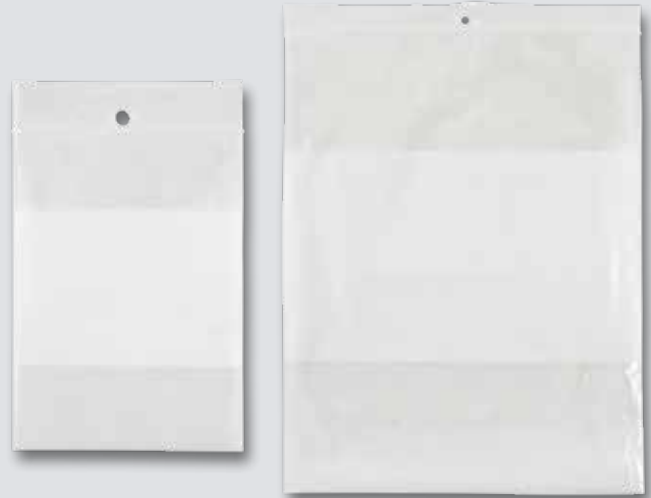

| Model No. | Dimensions W" x L" |
|-----------|--------------------|
| PF916 | 3 x 4 |
| PF918 | 3 x 5 |
| PF926 | 4 x 6 |
| PF933 | 5 x 8 |
| PF941 | 6 x 9 |
| PF948 | 8 x 10 |
| PF951 | 9 x 12 |
| PF963 | 12 x 15 |

4 MIL - RECLOSABLE POLY BAGS

- Hang-holes allow users to hang on hooks or pegs
- Zippered opening allows for easy opening and resealing
- Offers excellent protection for industrial parts and tools
- 4-mil thickness
- 100/pack
- Reclosable



| Model No. | Dimensions W" x L" |
|-----------|--------------------|
| PG387 | 3 x 4 |
| PG388 | 3 x 5 |
| PG389 | 4 x 4 |
| PG390 | 4 x 6 |
| PG391 | 5 x 8 |
| PG392 | 6 x 9 |
| PG393 | 8 x 10 |
| PG394 | 9 x 12 |
| PG395 | 12 x 15 |

PACKING LIST ENVELOPES

- Ideal for packing slips, invoices, spec sheets, warranties, instructions, etc.
- Backloading
- 1000/case



| Model No. | Outside Dimensions W" x L" | Inside Dimensions W" x L" | Description |
|-----------|-------------------------------|------------------------------|---------------------------------|
| PF878 | 5-1/2 x 4-1/2 | 5 x 4 | Packing List Enclosed/Bilingual |
| PF879 | 5-1/2 x 4-1/2 | 5 x 4 | Blank |
| PF880 | 5-1/2 x 4-1/2 | 5 x 4 | Packing List Enclosed |
| PF881 | 5-1/2 x 7 | 5 x 6-1/2 | Blank |
| PF882 | 5-1/2 x 7 | 5 x 6-1/2 | Packing List Enclosed/Bilingual |
| PF883 | 5-1/2 x 10 | 5 x 9-1/2 | Blank |

BUBBLE SHIPPING MAILER

- Protective shipping envelopes offer superior protection
- Lightweight saves on shipping costs
- Self-sealing adhesive closure
- Material: Kraft
- Sold/Price Per Envelope

| Model No. | Dimensions W" x L" |
|-----------|-----------------------|
| PG238 | 6 x 10 |
| PG239 | 5 x 10 |
| PG240 | 4 x 8 |
| PG241 | 7-1/4 x 12 |
| PG242 | 8-1/4 x 12 |
| PG243 | 8-1/4 x 14-1/2 |
| PG244 | 9-1/2 x 14-1/2 |
| PG245 | 10-1/2 x 16 |
| PG246 | 12-1/2 x 19 |
| PG247 | 14-1/4 x 20 |





Tape Selection Guide

What's the best tape for your application . . . hot melt or acrylic? When sealing a package, it's important to choose the right kind of carton sealing tape to ensure the box stays securely closed during shipping and/or storage. The following is a comparison of two popular types of carton sealing tape.

| Criteria | Hot Melt Tape | Acrylic Tape |
|-----------|---|---|
| Features | Overall superior holding power and tensile strength Quick tack, adheres with minimal pressure and contact time | Good for use in extreme temperatures Strong resistance to oxidation, will not yellow over time |
| Best Uses | Shipping and short term storage Sealing cartons made of recycled cardboard | Long-term storage Humid and dusty environments |

HOT MELT BOX SEALING TAPE

- Possesses superior holding power and tensile strength
- Ideal for use with boxes containing high amounts of recycled content
- Suitable for shipping and short-term storage
- Colour: Clear

| Model No. | Width | Length | Thickness |
|-----------|------------|--------------|-----------|
| PG127 | 48 mm (2") | 66 m (216') | 1.6 mils |
| PG128 | 48 mm (2") | 100 m (328') | 1.6 mils |
| PG129 | 48 mm (2") | 100 m (328') | 2 mils |
| PG130 | 72 mm (3") | 66 m (216') | 1.6 mils |
| PG131 | 48 mm (2") | 132 m (432') | 1.6 mils |



ACRYLIC BOX SEALING TAPE

- Elongation at break: 1.3
- Quality acrylic adhesive tape provides consistent performance
- Designed to resist center seam splitting
- Fits on most industrial tape guns
- Colour: Clear

| Model No. | Width | Length | Thickness |
|-----------|------------|--------------|-----------|
| PF231 | 48 mm (2") | 66 m (216') | 1.6 mils |
| PF232 | 48 mm (2") | 100 m (328') | 1.6 mils |
| PF233 | 48 mm (2") | 100 m (328') | 2 mils |
| PF234 | 72 mm (3") | 66 m (216') | 1.6 mils |
| PF235 | 48 mm (2") | 132 m (432') | 1.6 mils |



TAPE DISPENSERS & UTILITY TAPES

TAPE DISPENSERS

- Industrial quality tape guns constructed of steel and high impact plastic frame
- Adjustable brake lets you choose the desired release tension

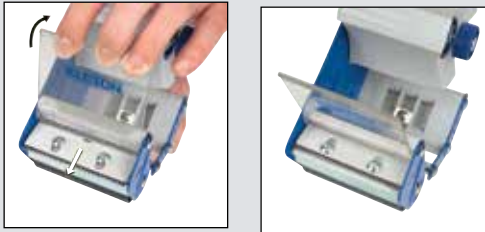

| Model No. | Description | Blade |
|-----------|--------------------------|-----------------|
| PE321 | 2" Standard-Duty Plastic | Retractable |
| PE322 | 2" Heavy-Duty Steel | Retractable |
| PE323 | 3" Heavy-Duty Steel | Retractable |
| PF712 | 2" Standard-Duty Plastic | Non-retractable |
| PF713 | 2" Heavy-Duty Steel | Non-retractable |
| PF714 | 3" Heavy-Duty Steel | Non-retractable |



PE321
Retractable safety blade
protects operator from injury

PF713
Non-Retractable
blade with safety cap

MANUAL KRAFT TAPE DISPENSER

- A single pull of the handle moistens and dispenses the required length of gummed tape
- Manual lever dispenses and cuts tape up to 44" long
- Weight: 20.46 lbs.

Model No. **PG200**
* Tape sold separately



REINFORCED KRAFT TAPE

- Water activated adhesive bonds to the carton even in dusty or dirty conditions
- Recommended for use on lightweight cartons of up to 20 lbs.
- Reinforced with fiberglass, adding strength to the tape
- Width: 75 mm (3")
- Length: 150 m (492')
- Colour: Kraft



Model No. **PG132**

UTILITY GRADE DUCT TAPE

- Ideal for a wide variety of projects and applications
- Water resistant
- Easy to tear
- Colour: Silver



| Model No. | Width | Length | Thickness |
|-----------|------------|-------------|-----------|
| PF688 | 50 mm (2") | 55 m (180') | 9 mils |
| PF689 | 50 mm (2") | 45 m (150') | 6 mils |
| PG374 | 50 mm (2") | 55 m (180') | 7.5 mils |

TEFLON® SEALING TAPE

- Commonly used in plumbing for sealing pipe threads
- Ensures a tight seal
- Works for both water and air
- Tape Material: PTFE
- Working Temperatures: -190°C to 260°C (-310°F to 500°F)



PG149

| Model No. | Width " | Length " | Thickness mils |
|-----------|---------|----------|----------------|
| PG148 | 1/2 | 520 | 3 |
| PG149 | 3/4 | 520 | 3 |

ALUMINUM FOIL TAPE

- For general purpose use (seaming, patching and sealing)
- Acrylic adhesive has excellent adhesion and permanently bonds to clean/dry surfaces
- Ideal for HVAC applications
- Temperature Resistance: -20 °C to 120 °C



PG176

| Model No. | Width | Length | Thickness |
|-----------|----------------|---------------|-----------|
| PG176 | 48 mm (1-7/8") | 45.7 m (150') | 1.5 mils |
| PG177 | 72 mm (3") | 45.7 m (150') | 1.5 mils |
| PG178 | 48 mm (1-7/8") | 55 m (180') | 2 mils |
| PG179 | 72 mm (3") | 55 m (180') | 2 mils |
| PG180 | 48 mm (1-7/8") | 55 m (180') | 4.8 mils |

MASKING TAPE

- Designed for all general purpose masking projects offering a good adhesion to a wide variety of surfaces.
- Resists lifting or curling
- Removes easily and cleanly
- Colour: Beige



PF886

| Model No. | Width | Length |
|-----------|--------------|-------------|
| PF886 | 18 mm (3/4") | 55 m (180') |
| PF887 | 24 mm (1") | 55 m (180') |
| PF888 | 48 mm (2") | 55 m (180') |

ELECTRICAL TAPE

- Electrical tape for splicing and insulating wires
- For use between -7°C and 80°C
- CSA approved
- Width: 19 mm (3/4")
- Length: 18m (60')
- Thickness: 7 mils



XE890

| Model No. | Colour |
|-----------|--------|
| XE890 | Black |
| XH383 | Red |
| XH384 | Green |
| XH385 | Blue |
| XH386 | White |
| XH387 | Yellow |

PF464



HEAT IMPULSE SEALERS

- Used for sealing polyethylene, polypropylene, and PVC bags
- Compact design
- Lightweight
- Easy to operate
- 110 V

| Model No. | Size" | Power | Replacement Silicon Strip | Replacement PTFE Strip |
|-----------|-------|-------|---------------------------|------------------------|
| PF464 | 8 | 260 W | PF467 | PF468 |
| PF465 | 12 | 380 W | PF470 | PF471 |

BAG SEALER

- Heavy-duty bag sealer with tape cutter
- Easy to use: simply twist bag shut and move through slot
- Fits tape width: 3/8"

Model No. PE356

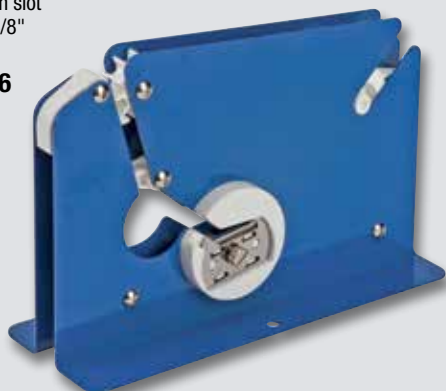

REPLACEMENT PARTS

Model No. PE383, Replacement Blade

CARTON SIZER

- Ideal for cutting boxes down to the desired depth
- Lowers cost on shipping and packaging fill materials
- 12" ruler allows for precise measuring

Model No. PF345



REPLACEMENT PARTS

Model No. PF346, Replacement Blade

FILAMENT TAPE DISPENSERS

- Hand filament tape dispenser
- For up to 1" wide rolls
- Metal construction

Model No. PE355



STRETCH WRAP DISPENSER

- Needle bearings at the top and bottom of the unit increase tension control
- Tension control knob on top ensures a tight, smooth wrap
- Tension knob also provides a second hand grip for added stability
- Top plate is constructed of cast aluminum for added durability
- Adjusts to hold rolls from 11" to 18" wide

Model No. PE354





STEEL STRAPPING & TOOLS

STEEL STRAPPING

- Strongest material for a wide range of strapping requirements
- Ideal for heavy shipments that require stronger protection over polypropylene and polyester
- Black painted and waxed finish
- Oscillated wound



| Model No. | Strap Width" x Thickness" | Core Dimensions" | Strength lbs. | Feet /Coil |
|-----------|---------------------------|------------------|---------------|------------|
| PG001 | 3/8 x 0.015 | 16 x 3 | 680 | 5310 |
| PG002 | 3/8 x 0.020 | 16 x 3 | 900 | 3800 |
| PG003 | 1/2 x 0.015 | 16 x 3 | 910 | 3550 |
| PF404 | 1/2 x 0.020 | 16 x 3 | 1200 | 2940 |
| PG004 | 1/2 x 0.023 | 16 x 3 | 1380 | 2370 |
| PG005 | 5/8 x 0.015 | 16 x 3 | 1125 | 2820 |
| PF405 | 5/8 x 0.020 | 16 x 3 | 1500 | 2360 |
| PG006 | 5/8 x 0.023 | 16 x 3 | 1725 | 1890 |
| PG007 | 3/4 x 0.015 | 16 x 3 | 1360 | 2385 |
| PF406 | 3/4 x 0.020 | 16 x 3 | 1800 | 1960 |
| PG008 | 3/4 x 0.023 | 16 x 3 | 2070 | 1580 |
| PF407* | 1-1/4 x 0.031 | 16 x 1-1/4 | 5500 | 760 |

* Ribbon wound

STEEL, PLASTIC & NYLON STRAPPING DISPENSER

- Strapping cart is designed to be compatible with polyester, polypropylene and steel strapping
- The unique multi-tier discs accommodate three core strapping sizes: 8" x 8", 16" x 3" and 16" x 6"
- Rubber rollers prevent strapping from unrolling
- Cart includes large storage tray for strapping accessories
- Heavy-duty 8" rubber wheels for easy maneuverability
- For use with 1/2" - 3/4" strapping



Model No. PE555

FIND OUT HOW IT WORKS
www.YouTube.com/KletonInd

For details and "HOW TO" on this and other KLETON products please visit us at:
www.youtube.com/user/KLETONInd



Model No. PG283

STEEL SEALS

- All fully galvanized steel
- Open (snap-on) type: Used on flat and smooth surfaces
- Fully closed (push) type: Used on curved and irregular surfaces

OPEN (SNAP-ON)

| Model No. | Strap Width" | Qty /Box |
|-----------|--------------|----------|
| PF408 | 1/2 | 2000 |
| PF409 | 5/8 | 2000 |
| PF410 | 3/4 | 2000 |
| PF411 | 1/2 | 5000 |
| PF412 | 5/8 | 5000 |
| PF413 | 3/4 | 5000 |
| PF414 | 1-1/4 | 1000 |

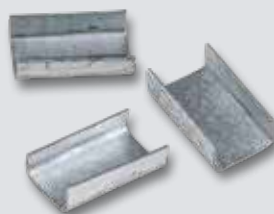

FULLY CLOSED (PUSH)

| Model No. | Strap Width" | Qty /Box |
|-----------|--------------|----------|
| PF415 | 1/2 | 2000 |
| PF416 | 5/8 | 2000 |
| PF417 | 3/4 | 2000 |
| PF418 | 1/2 | 5000 |
| PF419 | 5/8 | 5000 |
| PF420 | 3/4 | 5000 |
| PF421 | 1-1/4 | 1000 |



STEEL STRAPPING TOOLS

STEEL STRAPPING SEALERS

FOR USE WITH OPEN SEALS AND CLOSED SEALS

- Double notch creates a strong interlocking joint
- Heat-treated steel construction for added durability
- Ball handles provide a superior grip
- Ideal for use with feed-wheel tensioners

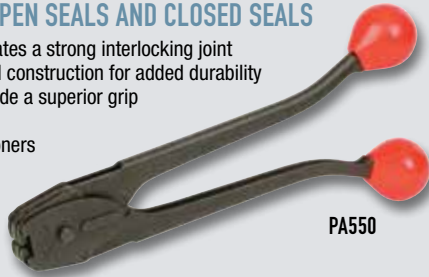

PA550

| Model No. | Strap Width" | Strap Thickness" |
|-----------|--------------|------------------|
| PA550 | 1/2 | 0.018 - 0.023 |
| PA562 | 5/8 | 0.018 - 0.023 |
| PA551 | 3/4 | 0.018 - 0.027 |

STEEL STRAPPING SEALERS

FOR USE WITH CLOSED AND SEMI-CLOSED SEALS

- Single notch for use with closed and semi-closed seals
- Chrome-plated steel construction
- Ball handles provide a superior grip
- Ideal for use with push-bar style tensioners



PE351

| Model No. | Strap Width" | Strap Thickness" |
|-----------|--------------|------------------|
| PE351 | 1/2 | 0.018 x 0.023 |
| PE352 | 5/8 | 0.018 x 0.023 |
| PE353 | 3/4 | 0.018 x 0.027 |

HEAVY-DUTY STEEL STRAPPING SEALERS

- Single notch
- Heat-treated steel construction for added durability
- Ideal for use with push-bar style tensioners
- For use with 1 1/4" wide steel strapping
- Accepts steel strapping between 0.025" to 0.035" in thickness

Model No. **PB016** For use with closed and semi-closed seals

Model No. **PF687** - For use with open seals



PB016

PF687

STEEL STRAPPING TENSIONERS

FEED-WHEEL STYLE

- Accepts steel strapping up to 0.035" thick
- Fast and easy operation
- Medium/heavy tension
- Unlimited take-up
- Ideal for applications on flat surfaces



PC938

| Model No. | Description | Strap Width" |
|-----------|-------------|--------------|
| PC938 | Standard | 3/8 - 3/4 |
| PC399 | Heavy-Duty | 3/4 - 1-1/4 |

STEEL STRAPPING TENSIONERS

PUSH BAR STYLE

- Accepts steel strapping up to 0.020" thick
- Light tension
- Limited take-up
- Ideal for applications on small, round or irregular surfaces
- For use with push type seals

| Model No. | Description | Strap Width" |
|-----------|-------------|--------------|
| PA567 | Standard | 3/8 - 1/2 |
| PE350 | Heavy-Duty | 3/8 - 3/4 |



PA567

PE350

STEEL STRAPPING TOOLS

STANDARD-DUTY SAFETY CUTTERS FOR STEEL STRAPPING

- Cuts steel strapping 3/8" - 1 1/4" wide x 0.036" thick
- Safety design holds strapping in place to prevent injuries from flying ends
- Rubber pads gently release strapping when being cut

Model No. **PC446**



HEAVY-DUTY SAFETY CUTTERS FOR STEEL STRAPPING

- Cuts steel strapping 3/8" - 2" wide x 0.050" thick
- Powerful drop-forged steel design
- Heavy-duty performance for industrial applications
- 24" long

Model No. **PC479**



MANUAL SEALLESS STEEL STRAPPING TOOL

- Multi purpose tool cuts, tightens and seals for optimal working efficiency
- Keeps straps secure with punch joint sealing
- Made to withstand high volume usage
- Fits strap width: 1/2" - 3/4"
- Fits strap thickness: 0.015" - 0.027"
- Type: Push Bar

Model No. **PF705**



1/2" STEEL STRAPPING KIT EASY-TO-USE, EFFICIENT SYSTEM

Contains closed seals for irregularly shaped surfaces
Consists of the following components:

- 1- **PF404** 1/2" x 0.020" steel strapping
- 1- **PC446** cutter 3/8" to 1-1/4"
- 1- **PA567** push bar tensioner 3/8" to 1/2"
- 1- **PE351** 1/2" wide sealer for closed seals
- 1- **PF415** 1/2" wide closed seals 2000/box
- 1- **PE555** dispenser

Model No. **PB655**



1/2" STEEL STRAPPING KIT EASY-TO-USE, EFFICIENT SYSTEM

Contains open seals for flat surfaces
Consists of the following components:

- 1- **PF404** 1/2" x 0.020" steel strapping
- 1- **PC446** cutter 3/8" to 1-1/4"
- 1- **PC938** 3/8" to 3/4" wide standard tensioner
- 1- **PA550** 1/2" wide sealer for open seals
- 1- **PF408** 1/2" wide open seals 2000/box
- 1- **PE555** dispenser

Model No. **PB654**



PLASTIC STRAPPING & DISPENSERS

EVERYTHING YOU NEED TO GET
YOUR SHIPMENTS PACKAGED
QUICKLY AND SAFELY

POLYPROPYLENE STRAPPING

- Ideal for light-duty palletizing and bundling
- Lightweight, easy-to-use and recyclable

| Model No. | Strap Width" | Strap Thickness" | Feet /Coil | Core Size" | Strength lbs. | Colour | Grade |
|-----------|--------------|------------------|------------|------------|---------------|--------|---------|
| PF983 | 3/8 | 0.024 | 12,900 | 8 x 8 | 300 | White | Machine |
| PF984 | 1/2 | 0.023 | 9,900 | 8 x 8 | 300 | White | Machine |
| PF985 | 1/2 | 0.035 | 5,600 | 16 x 6 | 750 | Black | Manual |
| PF986 | 1/2 | 0.032 | 7,200 | 16 x 6 | 600 | Black | Manual |
| PF987 | 1/2 | 0.032 | 7,200 | 8 x 8 | 600 | Black | Manual |
| PF988 | 5/8 | 0.030 | 6,000 | 8 x 8 | 700 | Black | Manual |

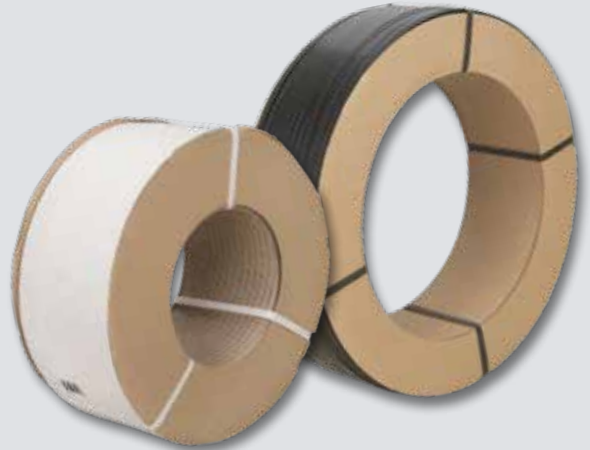

POLYESTER STRAPPING

- Ideal for medium to heavy-duty palletizing
- Moisture-resistant, safe to handle and recyclable
- Approved by the Association of American Railroads (AAR)
- 4000' coil
- 5/8" strap width
- 16" x 6" core size
- 1400 lbs. strength
- Manual grade
- 0.035" strap thickness

Model No. **PG175**

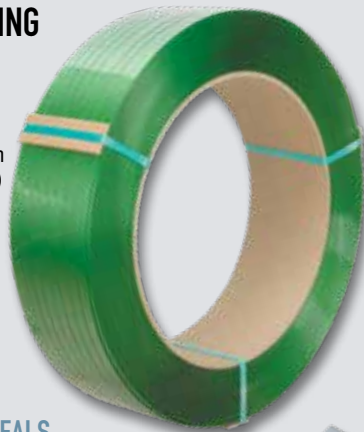

SERRATED STRAPPING SEALS

- Serrated seals for use with polyester strapping
- Fits 5/8" strap width
- Qty/Box: 1000

Model No. **PF991**

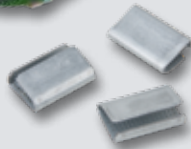

STEEL SEALS

- All fully galvanized steel
- Open (snap-on) type: Used on flat and smooth surfaces
- Fully closed (push) type: Used on curved and irregular surfaces



OPEN (SNAP-ON)

| Model No. | Strap Width" | Qty /Box |
|-----------|--------------|----------|
| PF408 | 1/2 | 2000 |
| PF409 | 5/8 | 2000 |
| PF410 | 3/4 | 2000 |
| PF411 | 1/2 | 5000 |
| PF412 | 5/8 | 5000 |
| PF413 | 3/4 | 5000 |
| PF414 | 1-1/4 | 1000 |

FULLY CLOSED (PUSH)

| Model No. | Strap Width" | Qty /Box |
|-----------|--------------|----------|
| PF415 | 1/2 | 2000 |
| PF416 | 5/8 | 2000 |
| PF417 | 3/4 | 2000 |
| PF418 | 1/2 | 5000 |
| PF419 | 5/8 | 5000 |
| PF420 | 3/4 | 5000 |
| PF421 | 1-1/4 | 1000 |

POLYPROPYLENE & POLYESTER STRAPPING DISPENSER

- Cart includes large storage tray for strapping accessories
- For use with 1/2" - 3/4" strapping
- Heavy-duty 8" rubber wheels for easy maneuverability
- Accommodates core inside diameter of 8"

Model No. **PF807**

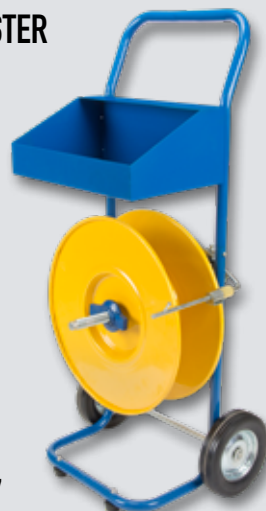

PF807

STEEL & PLASTIC STRAPPING DISPENSER

- Strapping cart is designed to be compatible with polyester, polypropylene and steel strapping
- The unique multi-tier discs accommodate three core strapping sizes: 8" x 8", 16" x 3" and 16" x 6"
- Rubber rollers prevent strapping from unrolling
- Cart includes large storage tray for strapping accessories
- Heavy-duty 8" rubber wheels for easy maneuverability
- For use with 1/2" - 3/4" strapping

Model No. **PE555**



PE555

POLYPROPYLENE & POLYESTER STRAPPING TENSIONERS

- Accepts strapping 3/8 - 3/4" wide and up to 0.035" in thickness
- Superior design and performance
- Premium copper bushings
- Built-in strapping cutter
- Ideal for applications on flat surfaces
- For use with open seals or buckles

Model No. **PC939**



POLYESTER STRAPPING TENSIONER

- Accepts strapping 3/8 - 3/4" wide and fits between 0.023" and 0.039" in thickness
- Tightens strapping quickly with little effort
- Built-in strapping cutter
- Ideal for applications on flat surfaces
- Compatible with polyester strapping

Model No. **PF993**



POLYPROPYLENE STRAPPING SEALERS

- Heat-treated steel construction for superior strength and durability
- Prevents strapping from loosening during transit
- Long 18" handle requires less effort
- Use on open steel seals



PA555

| Model No. | Strap Width" | Strap Thickness" |
|-----------|--------------|------------------|
| PA555 | 1/2 | ≤ 0.027 |
| PA556 | 5/8 | 0.023 - 0.039 |
| PF459 | 3/4 | ≤ 0.027 |

POLYESTER STRAPPING SEALER

- Heat-treated steel construction for superior strength and durability
- Prevents strapping from loosening during transit
- Long 18" handle requires less effort
- Offset jaws are longer on one side for better grip
- Specially designed for use with serrated seals
- Fits strap 5/8" strap width

Model No. **PF992**



5/8" POLYESTER STRAPPING KIT EASY-TO-USE, EFFICIENT SYSTEM

Consists of the following components:

- 1- **PE555** Dispenser,
- 1- **PG175** 5/8" x 4000' x 1400 lbs strength polyester strapping,
- 1- **PF991** 5/8" open seals, 1000/box,
- 1- **PF992** 5/8" polyester sealer,
- 1- **PF993** polyester strapping tensioner

Model No. **PG187**



1/2" POLYPROPYLENE STRAPPING KIT EASY-TO-USE, EFFICIENT SYSTEM

Consists of the following components:

- 1- **PF985** 1/2" X 5600' 750 lb strength polypropylene strapping
- 1- **PE555** dispenser
- 1- **PA555** 1/2" poly sealer
- 1- **PC939** polypropylene and polyester tensioner
- 1- **PF408** 1/2" open seals, 2000/box

Model No. **PD023**



GLUE GUNS & CABLE TIES

PROFESSIONAL GLUE GUNS

- Perfect for light-duty carton sealing or small manufacturing projects
- Accepts 7/16" diameter regular glue sticks
- Trigger design for better grip control
- Features precise, even adhesive distribution
- 120 V / 80 W heater
- Comes with metal wire stand

Model No. **PE339**



PE339

aurora tools[®]

HEAVY-DUTY GLUE GUNS

- Ideal for medium-heavy duty applications
- Accepts 7/16" diameter regular glue sticks
- Ergonomic trigger design for better grip and comfort
- Features precise, even adhesive distribution
- Illuminated on/off switch
- 120 V / 100 W heater
- Comes with metal wire stand

Model No. **PE340**



PE340

GLUE STICKS

| Model No. | Glue Type | Viscosity Centipoise | Melting Point | | Typical Applications | Dim." | Qty /Case |
|-----------|-----------|----------------------|---------------|---------|---|-----------|-----------|
| | | | °C | °F | | | |
| PE341 | Clear | 11000-13000 | 77-82 | 170-180 | High strength, high temp, for non-porous materials such as metal and plastics | 7/16 x 4 | 2000 |
| PE342 | Clear | 11000-13000 | 77-82 | 170-180 | High strength, high temp, for non-porous materials such as metal and plastics | 7/16 x 10 | 803 |
| PE343 | Amber | 5000 | 95 | 203 | For porous materials such as corrugated boxes or wood | 7/16 x 15 | 536 |
| PE541 | Clear | 9400 | 80 | 176 | All temp. all purpose for porous and non-porous materials | 7/16 x 10 | 803 |

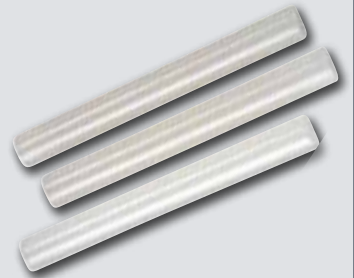

aurora tools[®]



CABLE TIE SETS

Model No. **PF397**

Set Includes: 400 x PF387, 400 x PF389, 200 x PF391

Model No. **PF398**

Set Includes: 50 x PF393, 50 x PF395

CABLE TIES

- Manufactured from Dupont™ Zytel®101F and Ascend™ Vydyne® 21SPF
- Ideal use in temperatures ranging from -20°C to 80°C
- **PF396** has the added benefit of weather resistance

| Model No. | Style | Length" | Bundle Dia. Min." - Max." | Tensile Strength lb | Qty /Bag |
|-----------|---------|---------|---------------------------|---------------------|----------|
| PF385 | Natural | 4 | 1/16 - 7/8 | 18 | 1000 |
| PF386 | Black | 4 | 1/16 - 7/8 | 18 | 1000 |
| PF387 | Natural | 6 | 1/16 - 1-1/4 | 40 | 1000 |
| PF388 | Black | 6 | 1/16 - 1-1/4 | 40 | 1000 |
| PF389 | Natural | 8 | 1/16 - 1-3/4 | 50 | 1000 |
| PF390 | Black | 8 | 1/16 - 1-3/4 | 50 | 1000 |
| PF391 | Natural | 11 | 1/16 - 3 | 50 | 1000 |
| PF392 | Black | 11 | 1/16 - 3 | 50 | 1000 |
| PF393 | Natural | 15-1/2 | 1/16 - 4 | 120 | 100 |
| PF394 | Black | 15-1/2 | 1/16 - 4 | 120 | 100 |
| PF395 | Natural | 24 | 1/16 - 7 | 175 | 100 |
| PF396 | Black | 24 | 1/16 - 7 | 175 | 100 |

HAMMER TACKERS AND STAPLE GUNS

HEAVY-DUTY STAPLE GUNS

- All-steel construction, with rubberized handle for superior grip
- Easy squeeze, double leverage handle reduces operators fatigue
- Hand-contoured handle features molded plastic handle stop
- Bottom loading, with jam proof mechanism
- Adjustable driving force facilitates use
- Accepts staples in 3 lengths: 5/16", 3/8" and 1/2", with a crown width of 3/8"

Model No. **PE337**



HEAVY-DUTY HAMMER TACKER

- All-steel construction, with rubberized handle for superior grip
- Precision locked rear loading, with jam proof mechanism
- Retractable striking edge
- Chrome plated finish
- Staple Size: 1/4" to 9/16"

Model No. **PG362**



STAPLES

| Model No. | Size" | Qty /Package |
|-----------|-------|--------------|
| ON919 | 5/16 | 500 |
| ON920 | 3/8 | 500 |
| ON921 | 1/2 | 500 |

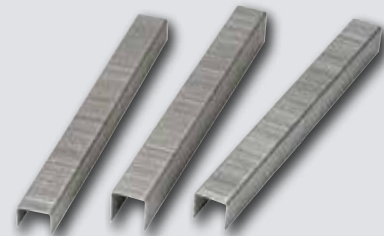

INDEX

A

| | |
|------------------|-----|
| Appliance Trucks | 81 |
| Acrylic Tape | 164 |

B

| | |
|-------------------------|-----------|
| Bag Sealer | 167 |
| Bar Cradle Carts | 110-111 |
| Bar Storage Racks | 37 |
| Basket Wire Shelving | 13 |
| Benches | 4 |
| Bins | 27-28, 31 |
| Bollards | 45 |
| Boltless Shelving | 18 |
| Box Sealing Tape | 164 |
| Box Truck | 83-85 |
| Bubble Shipping Mailers | 163 |
| Bulk Stacking Container | 35 |
| Bung Nut Wrenches | 151 |

C

| | |
|--------------------------|---------|
| Cabinet Workbenches | 138 |
| Cable Reel Rollers | 36 |
| Cable Ties | 174 |
| Can Tipper | 147 |
| Carousel Drawer Cabinets | 20 |
| Carton Racks | 38 |
| Carton Sizer | 167 |
| Casters | 114-117 |
| Chairs | 141 |
| Chair Caddy | 141 |
| Chain Hoists | 71 |
| Collapsible Containers | 30 |
| Cone Cart | 75 |
| Cork Boards | 142 |
| Corner Bumpers | 119 |
| Cradle Truck | 109 |

D

| | |
|---------------------|---------|
| Dead Skids | 103 |
| Dock Bumpers | 119 |
| Dollies | 107-109 |
| Drawer Cabinets | 20, 29 |
| Dry Erase Markers | 143 |
| Drywall Carts | 111 |
| Drum Dollies | 149 |
| Drum Faucets | 151 |
| Drum Grabbers | 146 |
| Drum Lifting Hook | 147 |
| Drum Pumps | 152-156 |
| Drum Rockers | 147 |
| Drum Stacking Racks | 146 |
| Drum Trucks | 148-149 |
| Duct Tape | 165 |
| Dump Hoppers | 83 |
| Dump Trucks | 82 |

E

| | |
|----------------------------------|-----|
| Elevated Platform Trucks | 102 |
| Enclosed Wire Stock Picking cart | 14 |

F

| | |
|--------------------------|-----|
| Filament Tape Dispensers | 167 |
| Flatbed Lumber Carts | 111 |
| Flat-Free Casters | 117 |
| Foldable Platform Trucks | 104 |
| Folding Benches | 141 |
| Folding Chairs | 141 |
| Folding Ladders | 56 |
| Folding Tables | 140 |
| Fork Extensions | 68 |
| Frame Sheet Carts | 110 |
| Furniture Pads | 50 |

G

| | |
|-----------------------|----|
| Gas Cylinder Cabinets | 39 |
| Gas Cylinder Carts | 77 |

| | |
|-----------------|-----|
| Glue Guns | 174 |
| Glue Sticks | 174 |
| Guard Rails | 46 |
| Guard Rail Post | 46 |

H

| | |
|---------------------------------|-------|
| Hammer Tackers | 75 |
| Hand Trucks | 74-81 |
| Hardwood Dollies | 107 |
| Heat Impulse Sealers | 167 |
| Hi-Stak Plastic Storage Bins | 27 |
| Hoists | 71-72 |
| Hydraulic Pallet Trucks | 64-67 |
| Hydraulic Platform Lift Stacker | 69 |

I - L

| | |
|------------------------------|---------|
| Ice Chock | 119 |
| Institutional Platform Truck | 104 |
| Jumbo Plastic Bins | 28 |
| Kraft Tape | 165 |
| Ladders | 53-56 |
| Lever Hoists | 72 |
| Lift Tables | 60-63 |
| Lockers | 4-5 |
| Locker Room Benches | 4, 144 |
| Louvered Racks | 31-33 |
| Low Profile Shelf Trucks | 92 |
| Lumber Carts | 111-112 |

M - O

| | |
|-------------------------|---------|
| Machine Stands | 139 |
| Mail Cart | 97 |
| Maintenance Platforms | 57-58 |
| Maxi-Bench Workstations | 137 |
| Mesh Stock Trucks | 85-88 |
| Mobile Service Trucks | 94 |
| Mobile Workbenches | 136-137 |
| Nylon Casters | 117 |
| Order Picking Trucks | 93 |

P

| | |
|-------------------------|----------|
| Packing List Envelopes | 163 |
| Pallet Dolly | 109 |
| Pallet Lifter | 70 |
| Pallet Pullers | 69 |
| Pallet Trucks | 64-67 |
| Panel Carts | 110, 113 |
| Parts Cabinets | 21-23 |
| Pedestals | 131 |
| Pedestal Benches | 136, 139 |
| Pipe & Bar Cradle Truck | |
| Plastic Storage Bins | 28 |
| Plastic Strapping | 172 |
| Platform Lift Stacker | 69 |
| Platform Trucks | 98-106 |
| Plug Wrench | 151 |
| Pneumatic Casters | 116 |
| Poly Bags | 162 |
| Polyester Strapping | 172 |
| Polyurethane Casters | 114 |
| Polyolefin Casters | 115 |
| Polypropylene Strapping | 172 |
| Protectors | 45 |

Q

| | |
|-------------|----|
| Quick Links | 69 |
|-------------|----|

R

| | |
|---------------------|-------|
| Racking Protectors | 44 |
| Reel Dispensers | 36 |
| Rolling Ladders | 55-56 |
| Rubber Casters | 116 |
| Rolling step ladder | 53-54 |

S

| | |
|---------------|--------|
| Safety Guards | 43, 45 |
| Sawhorses | 112 |

| | |
|-------------------------|--------------|
| Security Trucks | 88 |
| Self Dumpint Hoppers | 83 |
| Semi Live Skids | 103 |
| Semi-Pneumatic Wheel | 117 |
| Service Trucks | 94-95 |
| Sheet Racks | 38 |
| Shelf Trucks | 89-96 |
| Shop Desks | 144 |
| Siphon Pumps | 154 |
| Skids | 103 |
| Slanted Wire Shelving | 12-13 |
| Snap Hooks | 69 |
| Specialized Dollies | 108-109 |
| Spool Cart | 113 |
| Stacking Racks | 36 |
| Steel Dollies | 108 |
| Step Ladders | 55-56 |
| Step Stands & Platforms | 52 |
| Step Stool | 53, 142 |
| Steel Seals | 169, 172 |
| Steel Strapping | 169 |
| Stock Picking Trucks | 14 |
| Stool | 141 |
| Storage Bins & Racks | 31-34 |
| Storage Racks | 37-38 |
| Storage Cabinets | 24-26 |
| Staple Guns | 175 |
| Staples | 175 |
| Strapping cutters | 171 |
| Strapping Dispenser | 169, 171 |
| Strapping Kits | 171-172 |
| Strapping Sealers | 170-171, 173 |
| Strapping Seals | 169 |
| Strapping Tensioners | 170, 173 |
| Stretch Wrap Dispenser | 167 |
| Strip Curtains | 47 |

T

| | |
|-------------------------------|---------|
| Tape | 164-166 |
| Tape Dispensers | 165 |
| Tape Guns | 165 |
| Tarpaulins | 48-49 |
| Tie Downs | 50 |
| Tilt Bins | 29 |
| Tilt Bin Racks | 29 |
| Tilt-N-Roll Step Stands | 56 |
| Tilt-N-Roll Ladders | 56 |
| Tilt Trucks | 82 |
| Tool Box Benches | 137 |
| Trailer Access Rolling Ladder | 54 |
| Trailer Stabilizing Jack | 119 |
| Trolleys | 73 |

U - W

| | |
|-----------------------------------|------------------|
| U-Boat Platform Trucks | 110 |
| Upright Protectors | 45 |
| Utility Cart | 97 |
| Utility Knives | 160-161 |
| Wall Brackets | 68, 119 |
| Wagon Trucks | 102 |
| Water Pumps | 157-158 |
| Welding Cart | 77 |
| Workhorses | 112 |
| Wheel Chocks | 118-119 |
| White Boards | 142-143 |
| Wide Span Shelving | 18-19 |
| Wire Carts | 10 |
| Wire Mesh Partitions & Enclosures | 40-41 |
| Wire Mesh Partitions Kits | 42 |
| Wire Mesh Shelf Trucks | 85-88 |
| Wire Reel Cady | 113 |
| Wire Shelving | 6-17 |
| Wire Spool Cart | 113 |
| Work Benches | 121-130, 133-135 |
| Work Bench Tops | 132 |
| Work Platforms | 52 |



WARRANTY AND RETURN POLICY

KLETON WARRANTY

The warranty and return policy stated and described below pertain to all products carrying a KLETON logo located directly on the product or packaging. Such warranty supersedes any and all manufacturers' warranties, written or implied. KLETON's sole liability is limited to repair or replacement of any products proven to be defective in material and/or workmanship for one (1) year from the date of purchase, and for which a warranty claim is made, during the applicable warranty period, and no claims for damages of any type will be allowed. All products are sold on this specific interpretation. Defective warranted products will be repaired or replaced, at the discretion of KLETON, at no cost with a new or reconditioned product. Warranties only apply when the product is used for the purpose for which it was originally designed, in normal operating and other conditions. This warranty does not apply to products which have been abused, misused, modified or if the product is worn out from normal use or has been repaired by someone other than KLETON or an approved repair center. Discontinued warranted products will be replaced with products that are similar and available, or we will issue an appropriate credit. The specific warranty coverage for each product is as set out below. KLETON sells only on a wholesale basis and accordingly, warranties only apply to purchasers for resale or for use in their business.

HYDRAULIC PALLET TRUCK REPAIR WARRANTY

The complete hydraulic pump, handle assembly, frame and associated components are covered for one (1) year for the Standard-Duty models and two (2) years for the Heavy-Duty and specialized models. Wearable components such as wheels, rollers, and bushings are covered for six (6) months. Bent, twisted or misaligned forks are clear signs of abuse and as stated above, are not covered under warranty.

Parts used to perform authorized warranty repairs from a KLETON Dealer or Distributor's stock will be replaced at no charge pending return, receipt and examination of the defective parts. If the KLETON Dealer or Distributor does not have the necessary parts in stock, KLETON will ship the parts F.O.B. Montreal, QC and invoiced per normal. A credit will be issued for this invoice pending return, receipt and examination of the defective parts. KLETON will not accept claims for freight or transportation charges. Use of non-KLETON parts is not acceptable and any unauthorized parts usage will void all warranties.

RETURN POLICY

We will repair any defect due to faulty material or workmanship without charge. Please return the complete product or part as agreed upon, freight prepaid, to the KLETON Distributor where you purchased the product. These warranties do not cover failures due to abuse, misuse, normal wear, accidental damage or when repairs have been made or attempted by other than KLETON and its Authorized Service Centers. These warranties give you specific legal rights, and you may have other rights which vary from province to province. If you have any questions, please contact your assigned KLETON Distributor (proof of purchase is required).



**YOUR CANADIAN
WHOLESALE SOURCE**

Phone: 1-877-807-7772

Fax: 1-877-807-7775

Order on-line at www.scnindustrial.com

Email: sales@scnindustrial.com

www.kleton.com

